

BRIGHT-TOOLS

BRIGHT-TOOLS

BORING

BORING TOOLS

BRIGHT-TOOLS

BRIGHT-TOOLS

BRIGHT-TOOLS

BRIGHT-TOOLS

BRIGHT-TOOLS

BRIGHT-TOOLS

DCK Boring Tool Holder
DCK 镗刀柄

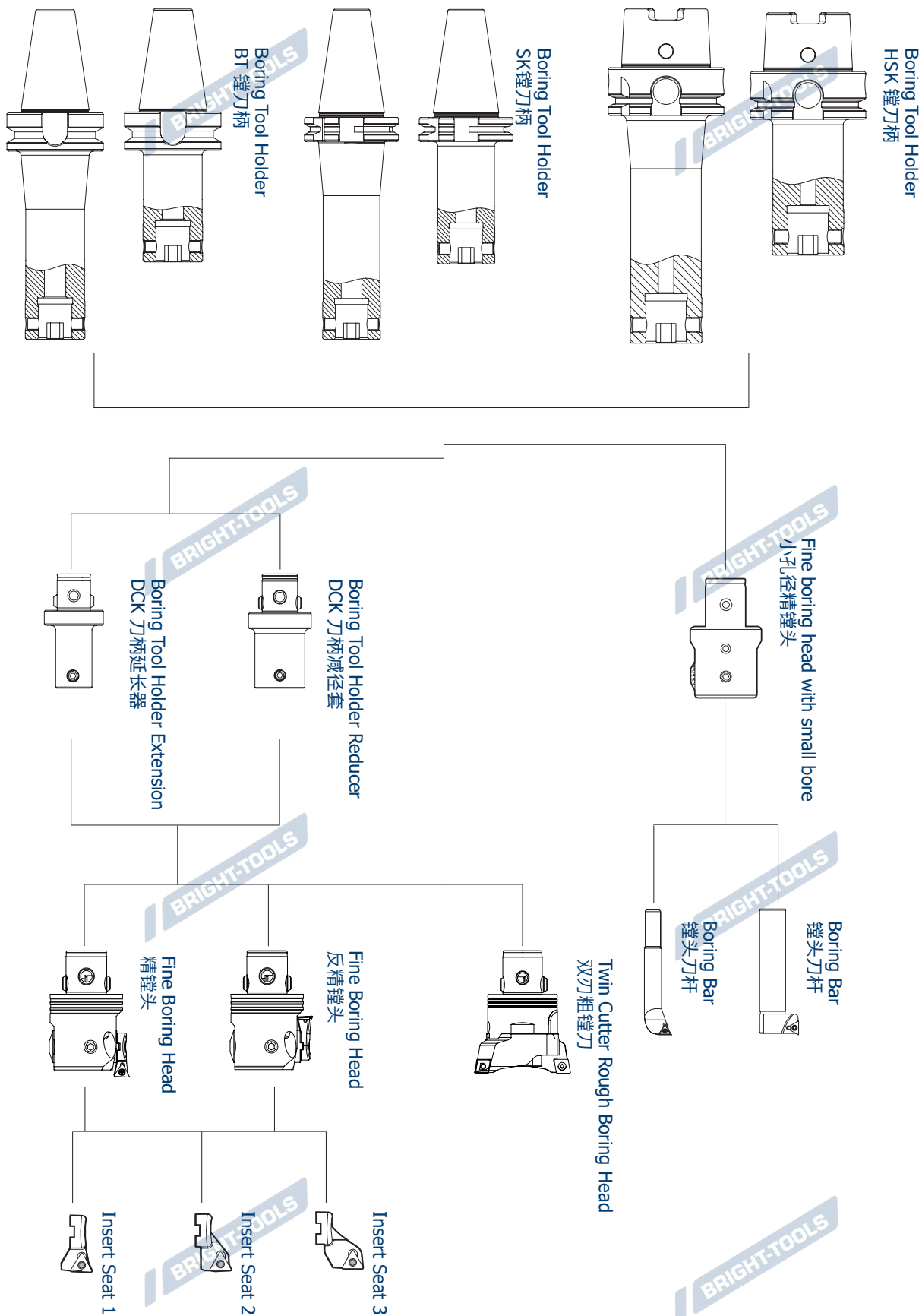

**Bridge Boring Tool Holder
桥镗刀柄**

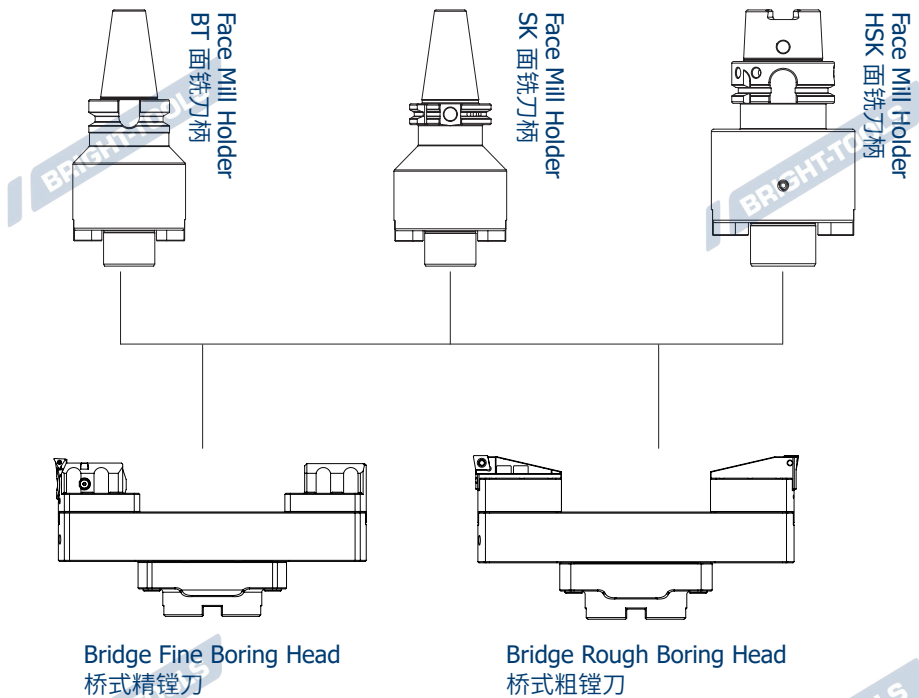

**NBH Boring Tool Holder
NBH 镗刀柄**

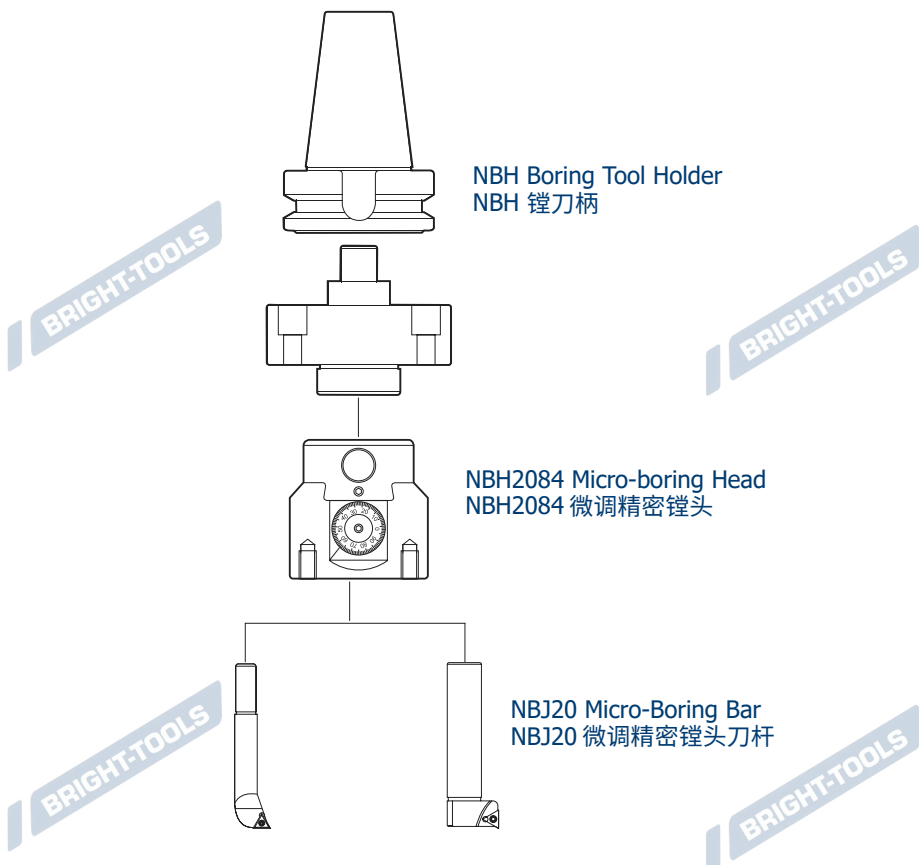

BORING TOOLING SYSTEM

BORING 工具系统

BT Boring Tool Holder.....	M.05
BT 镗刀柄	
BBT Boring Tool Holder.....	M.08
BBT 镗刀柄	
SK Boring Tool Holder.....	M.09
SK 镗刀柄	
HSK Boring Tool Holder.....	M.11
HSK 镗刀柄	
BT Bridge Boring Tool Holder.....	M.14
BT 桥镗刀柄	
SK Bridge Boring Tool Holder.....	M.14
SK 桥镗刀柄	
HSK Bridge Boring Tool Holder.....	M.15
HSK 桥镗刀柄	
NBH Boring Tool Holder.....	M.16
HSK 桥镗刀柄	
Boring Tool Holder Extension.....	M.17
DCK 刀柄延长器	
Boring Tool Holder Reducer.....	M.18
DCK 刀柄减径套	
Fine Boring Head.....	M.19
精镗头	
Twin Cutter Rough Boring Head.....	M.20
双刃粗镗刀	
Bridge Fine Boring Head.....	M.22
桥式精镗刀	
Bridge Roring Boring Head.....	M.23
桥式双刃粗镗刀	
OD Turning Holders.....	M.25
外镗	
Small Fine Boring Head.....	M.26
精镗小刀夹	
Fine Boring Unit.....	M.27
精镗单元	
NBJ16 Fine boring head with small bore.....	M.28
小孔径精镗头	
NBJ16 Micro-Boring Bar.....	M.28
微调精密镗头刀杆	
NBJ16 Micro-boring Tool Kit.....	M.29
微调精镗套装组合	
NBH2084 Micro-boring Head.....	M.30
微调精密镗头	
NBJ20 Micro-Boring Bar.....	M.30
微调精密镗头刀杆	
NBJ20 Micro-boring Tool Kit.....	M.31
微调精镗套装组合	
DCK5-FB50P Micro-nishing Boring Kit.....	M.32
极细微调精镗孔系统	
DCK6-FB63P Micro-nishing Boring Kit.....	M.33
极细微调精镗孔系统	
Boring Tool Holder Set.....	M.34
镗刀柄套装	



Boring Tool Holder 镗刀柄

A ↗
≤0.003

RPM
G6.3/15000

AD

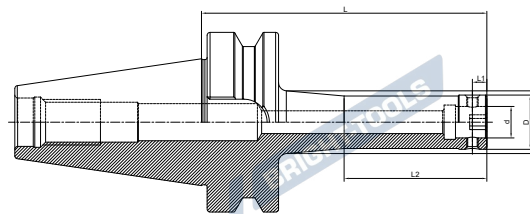

Size	DCK No.	D	d	L	L2	d1
BT30-DCK1-55	DCK1	19	11	55	-	-
BT30-DCK1-70	DCK1	19	11	70	-	-
BT30-DCK2-80	DCK2	24	14	80	-	-
BT30-DCK3-80	DCK3	31	18	80	-	-
BT30-DCK4-70	DCK4	39	22	70	-	-
BT30-DCK5-70	DCK5	50	28	70	-	-
BT30-DCK6-70	DCK6	64	36	70	-	-
BT40-DCK1-70	DCK1	19	11	70	-	-
BT40-DCK1-100T	DCK1	19	11	100	60	20.7
BT40-DCK1-130T	DCK1	19	11	130	60	25.9
BT40-DCK2-75	DCK2	24	14	75	-	-
BT40-DCK2-100	DCK2	24	14	100	-	-
BT40-DCK2-130T	DCK2	24	14	130	65	30
BT40-DCK2-160T	DCK2	24	14	160	75	33.6
BT40-DCK3-80	DCK3	31	18	80	-	-
BT40-DCK3-100	DCK3	31	18	100	-	-
BT40-DCK3-135T	DCK3	31	18	135	75	34.5
BT40-DCK3-165T	DCK3	31	18	165	85	39.7
BT40-DCK4-70	DCK4	39	22	70	-	-
BT40-DCK4-100	DCK4	39	22	100	-	-
BT40-DCK4-150T	DCK4	39	22	150	85	43.4
BT40-DCK4-170T	DCK4	39	22	170	95	46.9
BT40-DCK5-80	DCK5	50	28	80	-	-
BT40-DCK5-100	DCK5	50	28	100	-	-
BT40-DCK5-150	DCK5	50	28	150	-	-
BT40-DCK5-180	DCK5	50	28	180	-	-
BT40-DCK6-60	DCK6	64	36	60	-	-
BT40-DCK6-100	DCK6	64	36	100	-	-
BT40-DCK6-150	DCK6	64	36	150	-	-
BT40-DCK6-180	DCK6	64	36	180	-	-

T refers to cutter side with taper design

T代表刀具端锥柄设计

Boring Tool Holder
镗刀柄

A ↗ ≤0.003	RPM G6.3/15000	AD
---------------	-------------------	----

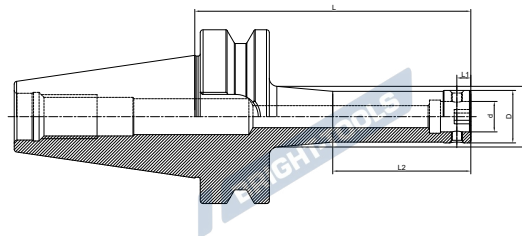

Size	DCK No.	D	d	L	L2	d1
BT50-DCK1-80	DCK1	19	11	80	-	-
BT50-DCK1-115T	DCK1	19	11	115	50	22.2
BT50-DCK1-145T	DCK1	19	11	145	60	26
BT50-DCK2-80	DCK2	24	14	80	-	-
BT50-DCK2-105	DCK2	24	14	105	-	-
BT50-DCK2-135T	DCK2	24	14	135	65	26.6
BT50-DCK2-165T	DCK2	24	14	165	75	31.9
BT50-DCK3-85	DCK3	31	18	85	-	-
BT50-DCK3-110	DCK3	31	18	110	-	-
BT50-DCK3-140T	DCK3	31	18	140	75	34.2
BT50-DCK3-170T	DCK3	31	18	170	85	38
BT50-DCK4-100	DCK4	39	22	100	-	-
BT50-DCK4-160T	DCK4	39	22	160	85	42.5
BT50-DCK4-205T	DCK4	39	22	205	95	50
BT50-DCK5-90	DCK5	50	28	90	-	-
BT50-DCK5-165	DCK5	50	28	165	-	-
BT50-DCK5-210T	DCK5	50	28	210	120	57.8
BT50-DCK5-270T	DCK5	50	28	270	120	68.4
BT50-DCK6-85	DCK6	64	36	85	-	-
BT50-DCK6-155	DCK6	64	36	155	-	-
BT50-DCK6-215	DCK6	64	36	215	-	-
BT50-DCK6-250	DCK6	64	36	250	-	-
BT50-DCK6-300T	DCK6	64	36	300	160	80.5
BT50-DCK6-350T	DCK6	64	36	350	160	90
BT50-DCK7-85	DCK7	90	46	85	-	-
BT50-DCK7-100	DCK7	90	46	100	-	-
BT50-DCK7-150	DCK7	90	46	150	-	-
BT50-DCK7-210	DCK7	90	46	210	-	-
BT50-DCK7-250	DCK7	90	46	250	-	-
BT50-DCK7-300	DCK7	90	46	300	-	-
BT50-DCK7-350	DCK7	90	46	350	-	-

T refers to cutter side with taper design

T代表刀具端锥柄设计

Boring Tool Holder

镗刀柄

A ↗
≤0.003

RPM
G6.3/15000

AD

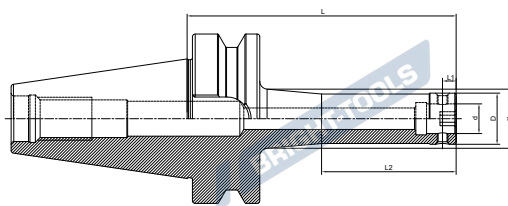

Size	DCK No.	D	d	L	L2	d1
BBT40-DCK1-70	DCK1	19	11	70	-	-
BBT40-DCK1-100T	DCK1	19	11	100	60	20.7
BBT40-DCK2-75	DCK2	24	14	80	-	-
BBT40-DCK2-100	DCK2	24	14	100	-	-
BBT40-DCK2-160T	DCK2	24	14	160	75	33.6
BBT40-DCK3-80	DCK3	31	18	80	-	-
BBT40-DCK3-100	DCK3	31	18	100	-	-
BBT40-DCK3-165T	DCK3	31	18	165	85	39.7
BBT40-DCK4-70	DCK4	39	22	70	-	-
BBT40-DCK4-100	DCK4	39	22	100	-	-
BBT40-DCK4-150T	DCK4	39	22	150	85	43.4
BBT40-DCK5-80	DCK5	50	28	80	-	-
BBT40-DCK5-100	DCK5	50	28	100	-	-
BBT40-DCK5-150	DCK5	50	28	150	-	-
BBT40-DCK5-180	DCK5	50	28	180	-	-
BBT40-DCK6-60	DCK6	64	36	60	-	-
BBT40-DCK6-100	DCK6	64	36	100	-	-
BBT40-DCK6-150	DCK6	64	36	150	-	-
BBT40-DCK6-180	DCK6	64	36	180	-	-

T refers to cutter side with taper design

T代表刀具端锥柄设计

Boring Tool Holder
镗刀柄

A ↗ ≤0.003	RPM G6.3/15000	AD
---------------	-------------------	----

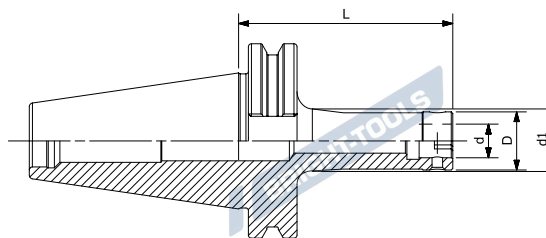

Size	DCK No.	D	d	L	L2	d1
SK30-DCK1-70	DCK1	19	11	70	-	-
SK30-DCK2-70	DCK2	24	14	70	-	-
SK30-DCK3-70	DCK3	31	18	70	-	-
SK30-DCK4-70	DCK4	39	22	70	-	-
SK30-DCK5-70	DCK5	50	28	70	-	-
SK30-DCK6-80	DCK6	64	36	80	-	-
SK40-DCK1-70	DCK1	19	11	70	-	-
SK40-DCK1-100T	DCK1	19	11	100	60	23.5
SK40-DCK2-70	DCK2	24	14	70	-	-
SK40-DCK2-100	DCK2	24	14	100	-	-
SK40-DCK2-130T	DCK2	24	14	130	75	31.1
SK40-DCK2-160T	DCK2	24	14	160	75	34.6
SK40-DCK3-80	DCK3	31	18	80	-	-
SK40-DCK3-100	DCK3	31	18	100	-	-
SK40-DCK3-130T	DCK3	31	18	130	85	31.6
SK40-DCK3-160T	DCK3	31	18	160	85	41.4
SK40-DCK4-70	DCK4	39	22	70	-	-
SK40-DCK4-100	DCK4	39	22	100	-	-
SK40-DCK4-150T	DCK4	39	22	150	95	46.8
SK40-DCK5-80	DCK5	50	28	50	-	-
SK40-DCK5-100	DCK5	50	28	100	-	-
SK40-DCK5-150	DCK5	50	28	150	-	-
SK40-DCK5-180	DCK5	50	28	180	-	-
SK40-DCK6-90	DCK6	64	36	90	-	-
SK40-DCK6-150	DCK6	64	36	150	-	-
SK40-DCK6-180	DCK6	64	36	180	-	-
SK40-DCK7-100	DCK7	90	46	100	-	-

T refers to cutter side with taper design

T 代表刀具端锥柄设计

Boring Tool Holder

镗刀柄

A ↗ ≤0.003	RPM G6.3/15000	 AD
----------------------	--------------------------	--

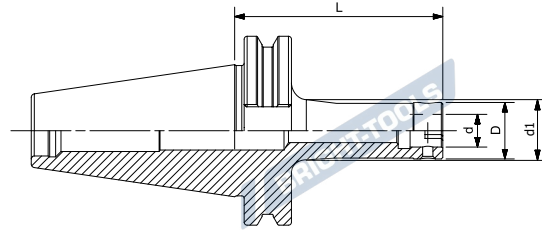

Size	DCK No.	D	d	L	L2	d1
SK50-DCK1-80	DCK1	19	11	80	-	-
SK50-DCK1-115	DCK1	19	11	115	60	25.8
SK50-DCK1-145	DCK1	19	11	145	60	29.3
SK50-DCK2-80	DCK2	24	14	80	-	-
SK50-DCK2-105	DCK2	24	14	105	-	-
SK50-DCK2-135T	DCK2	24	14	135	75	31.7
SK50-DCK2-165T	DCK2	24	14	165	75	35.2
SK50-DCK3-85	DCK3	31	18	85	-	-
SK50-DCK3-110	DCK3	31	18	110	-	-
SK50-DCK3-140T	DCK3	31	18	140	85	37.8
SK50-DCK3-170T	DCK3	31	18	170	85	41.3
SK50-DCK4-70	DCK4	39	22	70	-	-
SK50-DCK4-100	DCK4	39	22	100	-	-
SK50-DCK4-160T	DCK4	39	22	160	95	47.5
SK50-DCK4-200T	DCK4	39	22	200	95	53.7
SK50-DCK5-90	DCK5	50	28	90	-	-
SK50-DCK5-160	DCK5	50	28	160	-	-
SK50-DCK5-210T	DCK5	50	28	210	120	61.2
SK50-DCK5-250T	DCK5	50	28	250	120	71.7
SK50-DCK6-90	DCK6	64	36	90	-	-
SK50-DCK6-160	DCK6	64	36	160	-	-
SK50-DCK6-200	DCK6	64	36	200	-	-
SK50-DCK6-250	DCK6	64	36	250	-	-
SK50-DCK6-300T	DCK6	64	36	300	160	75
SK50-DCK7-85	DCK7	90	46	85	-	-
SK50-DCK7-100	DCK7	90	46	100	-	-
SK50-DCK7-150	DCK7	90	46	150	-	-
SK50-DCK7-210	DCK7	90	46	210	-	-
SK50-DCK7-250	DCK7	90	46	250	-	-
SK50-DCK7-300	DCK7	90	46	300	-	-
SK50-DCK7-350	DCK7	90	46	350	-	-

T refers to cutter side with taper design

T 代表刀具端锥柄设计

Boring Tool Holder
镗刀柄

A ↗ ≤0.003	RPM G6.3/15000	AD
---------------	-------------------	----

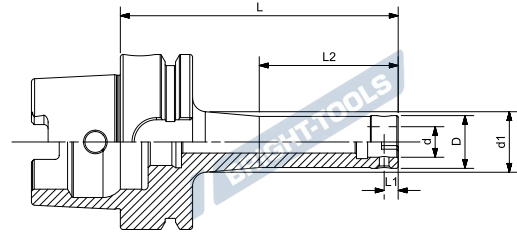

Size	DCK No.	D	d	L	L2	d1
HSK40A-DCK1-75	DCK1	19	11	75	-	-
HSK40A-DCK2-85	DCK2	24	14	85	-	-
HSK40A-DCK3-80	DCK3	31	18	80	-	-
HSK40A-DCK4-75	DCK4	39	22	75	-	-
					-	-
HSK50A-DCK1-75	DCK1	19	11	75	-	-
HSK50A-DCK2-85	DCK2	24	14	85	-	-
HSK50A-DCK3-80	DCK3	31	18	80	-	-
HSK50A-DCK4-75	DCK4	39	22	75	-	-
HSK50A-DCK5-85	DCK5	50	28	85	-	-
HSK63A-DCK1-70	DCK1	19	11	70	-	-
HSK63A-DCK1-100T	DCK1	19	11	100	50	21.8
HSK63A-DCK2-75	DCK2	24	14	75	-	-
HSK63A-DCK2-100	DCK2	24	14	100	-	-
HSK63A-DCK2-130T	DCK2	24	14	130	65	31
HSK63A-DCK3-80	DCK3	31	18	80	-	-
HSK63A-DCK3-100	DCK3	31	18	100	-	-
HSK63A-DCK3-135T	DCK3	31	18	135	75	37
HSK63A-DCK3-165T	DCK3	31	18	165	85	41
HSK63A-DCK4-70	DCK4	39	22	70	-	-
HSK63A-DCK4-100	DCK4	39	22	100	-	-
HSK63A-DCK4-150T	DCK4	39	22	150	95	44
HSK63A-DCK4-170T	DCK4	39	22	170	95	47.5
HSK63A-DCK5-80	DCK5	50	28	80	-	-
HSK63A-DCK5-100	DCK5	50	28	100	-	-
HSK63A-DCK5-150	DCK5	50	28	150	-	-
HSK63A-DCK5-180	DCK5	50	28	180	-	-
HSK63A-DCK6-100	DCK6	64	36	100	-	-
HSK63A-DCK6-150	DCK6	64	36	150	-	-
HSK63A-DCK6-180	DCK6	64	36	180	-	-

T refers to cutter side with taper design

T 代表刀具端锥柄设计

Boring Tool Holder

镗刀柄

A ↗
≤0.003

RPM
G6.3/15000

AD

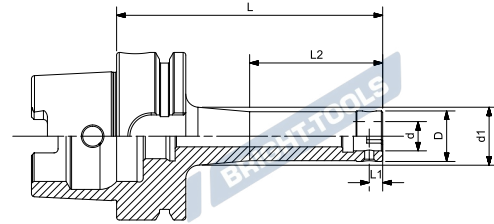

Size	DCK No.	D	d	L	L2	d1
HSK100A-DCK1-80	DCK1	19	11	80	-	-
HSK100A-DCK1-115T	DCK1	19	11	115	50	24
HSK100A-DCK1-145T	DCK1	19	11	145	60	27.5
HSK100A-DCK2-80	DCK2	24	14	80	-	-
HSK100A-DCK2-105	DCK2	24	14	105	-	-
HSK100A-DCK2-135T	DCK2	24	14	135	65	30
HSK100A-DCK2-165T	DCK2	24	14	165	75	33.5
HSK100A-DCK2-85	DCK3	31	18	85	-	-
HSK100A-DCK3-110	DCK3	31	18	110	-	-
HSK100A-DCK3-140T	DCK3	31	18	140	75	35.5
HSK100A-DCK3-170T	DCK3	31	18	170	85	41
HSK100A-DCK4-100	DCK4	39	22	100	-	-
HSK100A-DCK4-160T	DCK4	39	22	160	58	47
HSK100A-DCK4-205T	DCK4	39	22	205	110	50.5
HSK100A-DCK5-90	DCK5	50	28	90	-	-
HSK100A-DCK5-165	DCK5	50	28	165	-	-
HSK100A-DCK5-210T	DCK5	50	28	210	120	61
HSK100A-DCK5-270T	DCK5	50	28	270	130	69.5
HSK100A-DCK6-85	DCK6	64	36	85	-	-
HSK100A-DCK6-155	DCK6	64	36	155	-	-
HSK100A-DCK6-215	DCK6	64	36	215	-	-
HSK100A-DCK6-250	DCK6	64	36	250	-	-
HSK100A-DCK6-300T	DCK6	64	36	300	180	80
HSK100A-DCK7-125	DCK7	90	46	125	-	-
HSK100A-DCK7-200	DCK7	90	46	200	-	-
HSK100A-DCK7-275	DCK7	90	46	275	-	-

Boring Tool Holder
镗刀柄

A ↗ ≤0.003	RPM G6.3/15000	AD
---------------	-------------------	----

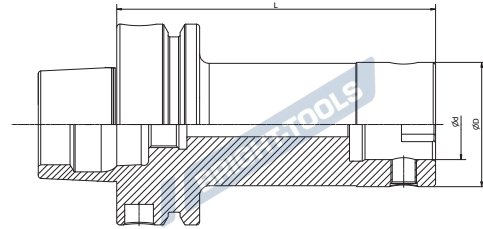

Size	DCK No.	D	d	L
HSK63F-DCK1-70	DCK1	19	11	70
HSK63F-DCK2-75	DCK2	24	14	75
HSK63F-DCK3-80	DCK3	31	18	80
HSK63F-DCK4-70	DCK4	39	22	70
HSK63F-DCK5-80	DCK5	50	28	80

TOOL HOLDER JIS B 6399

Bridge Boring Tool Holder
BST 桥镗刀柄

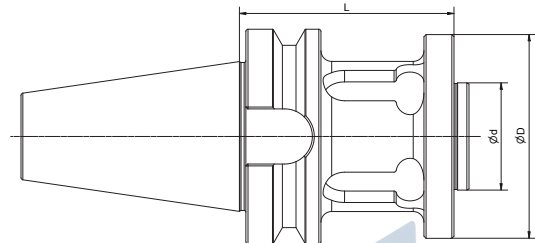

Size	D	d	L
BT40-BST-60	95	50	60
BT40-BST-100	95	50	100
BT40-BST-150	95	50	150
BT50-BST-100	95	50	100
BT50-BST-150	95	50	150
BT50-BST-200	95	50	200
BT50-BST-250	95	50	250
BT50-BST-300	95	50	300
BT50-BST-350	95	50	350
BT50-BST-400	95	50	400
BT50-BST-450	95	50	450
BT50-BST-500	95	50	500

Bridge Boring Tool Holder

BST 桥镗刀柄

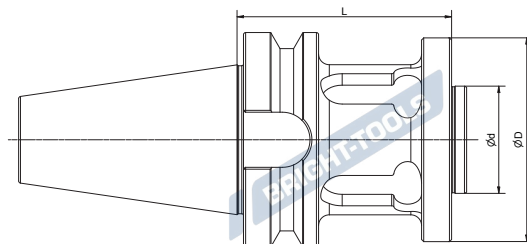

Size	D	d	L
BBT40-BST-60	95	50	60
BBT40-BST-100	95	50	100
BBT40-BST-150	95	50	150
BBT50-BST-100	95	50	100
BBT50-BST-150	95	50	150
BBT50-BST-200	95	50	200
BBT50-BST-250	95	50	250
BBT50-BST-300	95	50	300
BBT50-BST-350	95	50	350
BBT50-BST-400	95	50	400

TOOL HOLDER DIN 69871

Bridge Boring Tool Holder

BST 桥镗刀柄

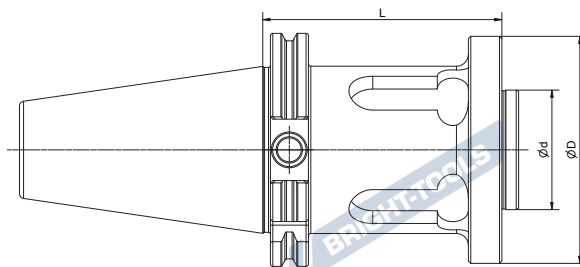

Size	D	d	L
SK40-BST-60	95	50	60
SK40-BST-100	95	50	100
SK50-BST-100	95	50	100
SK50-BST-150	95	50	150
SK50-BST-200	95	50	200
SK50-BST-250	95	50	250
SK50-BST-300	95	50	300
SK50-BST-350	95	50	350
SK50-BST-400	95	50	400
SK50-BST-450	95	50	450

Bridge Boring Tool Holder
BST 桥镗刀柄

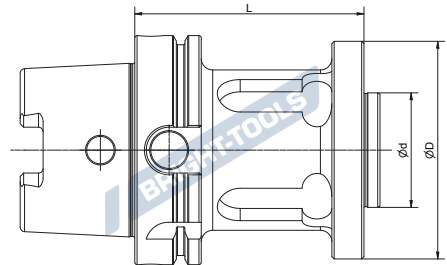

Size	D	d	L
HSK63A-BST-60	95	50	60
HSK63A-BST-100	95	50	100
HSK100A-BST-100	95	50	100
HSK100A-BST-150	95	50	150
HSK100A-BST-200	95	50	200
HSK100A-BST-250	95	50	250
HSK100A-BST-300	95	50	300



NBH Boring Tool Holder

NBH 镗刀柄

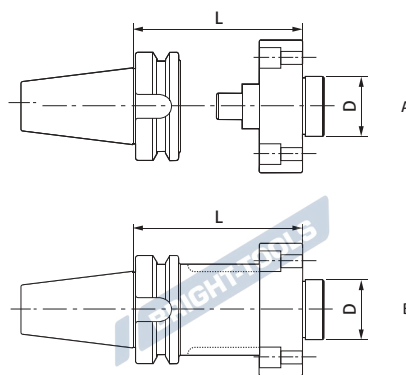

Size	Design	D	L	Wt
BT40-NBH-A50	A	35	50	1.78
BT50-NBH-A50	A	35	50	4.16
BT40-NBH-B100	B	35	100	2.23
BT50-NBH-B100	B	35	100	4.84
BT50-NBH-B165	B	35	165	6.23
BT50-NBH-B200	B	35	200	7.01
BT50-NBH-B250	B	35	250	7.96
BT50-NBH-B300	B	35	300	9.07

Boring Tool Holder Extension

DCK 刀柄延长器

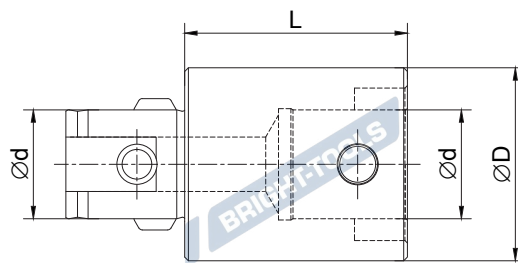

Size	DCK No.	d	D	L
DCK1-1-30	11	11	19	30
DCK1-1-100	11	11	19	100
DCK2-2-30	14	14	24	30
DCK2-2-100	14	14	24	100
DCK2-2-150	14	14	24	150
DCK3-3-30	18	18	31	30
DCK3-3-100	18	18	31	100
DCK3-3-150	18	18	31	150
DCK4-4-45	22	22	39	45
DCK4-4-100	22	22	39	100
DCK4-4-150	22	22	39	150
DCK5-5-60	28	28	50	60
DCK5-5-100	28	28	50	100
DCK5-5-150	28	28	50	150
DCK6-6-60	36	36	64	60
DCK6-6-100	36	36	64	100
DCK6-6-150	36	36	64	150

Usage: connect boring tool holder and boring head, to extend the working depth.

用途：连接镗刀架和镗头，延长工作深度。

Boring Tool Holder Reducer DCK 刀柄减径套

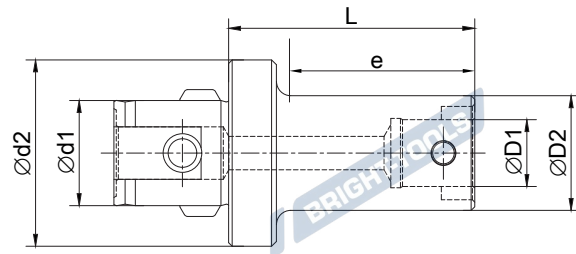

Size	d1	d2	D1	D2	L	e
DCK2-1-36	14	24	11	19	36	30
DCK3-1-41	18	31	11	19	41	30
DCK3-2-37	18	31	14	24	37	25
DCK4-1-58	22	39	11	19	58	40
DCK4-2-50	22	39	14	24	50	36
DCK4-3-50	22	39	18	31	50	37
DCK5-1-60	28	50	11	19	60	40
DCK5-2-54	28	50	14	24	54	35
DCK5-2-74	28	50	14	24	74	55
DCK5-3-47	28	50	18	31	47	29
DCK5-3-72	28	50	18	31	72	54
DCK5-4-42	28	50	22	39	42	25
DCK5-4-67	28	50	22	39	67	50
DCK6-1-70	36	64	11	19	70	40
DCK6-2-63	36	64	14	24	63	45
DCK6-2-93	36	64	14	24	93	75
DCK6-3-56	36	64	18	31	56	39
DCK6-3-96	36	64	18	31	96	79
DCK6-4-51	36	64	22	39	51	35
DCK6-4-101	36	64	22	39	101	85
DCK6-5-41	36	64	28	50	41	25
DCK6-5-91	36	64	28	50	91	75
DCK7-6-106	46	90	36	64	106	99

Usage: to connect with small size boring head.
用途：用于连接小型镗头。

Fine Boring Head

精镗头

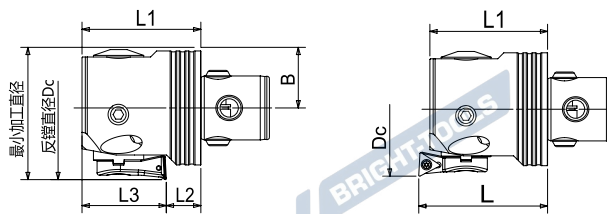

Size	Insert Seat	DCK NO.	R Boring			F Back Boring				Insert
			DC	L	L1	Dc	L2	L3	B	
DCK1-F2036	F1-1	DCK1	20-26	32	30.5	-	10.5	20	10	TP08
	F1-2	DCK1	25-31	32	30.5	30-31	10.5	20	10	TP08
	F1-3	DCK1	30-36	32	30.5	30-36	10.5	20	10	TP08
DCK2-F2547	F2-1	DCK2	25-33	36	33	-	11.5	21.5	12.5	TP08
	F2-2	DCK2	32-40	36	33	36-40	11.5	21.5	12.5	TP08
	F2-3	DCK2	39-47	36	33	39-47	11.5	21.5	12.5	TP08
DCK3-F3260	F3-1	DCK3	32-42	40	37	-	10	27	16	TP08
	F3-2	DCK3	41-51	40	37	46-51	10	27	16	TP08
	F3-3	DCK3	50-60	40	37	50-60	10	27	16	TP08
DCK4-F4174	F4-1	DCK4	41-54	46	43	-	14	29	20	TC11
	F4-2	DCK4	50-63	46	43	53-63	14	29	20	TC11
	F4-3	DCK4	61-74	46	43	61-74	14	29	20	TC11
DCK5-F5395	F5-1	DCK5	53-70	57	52	62-70	19	33	25.5	TC11
	F5-2	DCK5	65-82	57	52	65-82	19	33	25.5	TC11
	F5-3	DCK5	78-95	57	52	78-95	19	33	25.5	TC11
DCK6-F68150	F6-1	DCK6	68-100	71	67	80-100	22	45	32.5	TC11
	F6-2	DCK6	94-126	71	67	94-126	22	45	32.5	TC11
	F6-3	DCK6	118-150	71	67	118-150	22	45	32.5	TC11
DCK6-F100203	F6-1	DCK6	100-153	71	67	112-153	22	45	45.5	TC11
	F6-2	DCK6	126-179	71	67	126-179	22	45	45.5	TC11
	F6-3	DCK6	150-203	71	67	150-203	22	45	45.5	TC11

Delivery: inserts excluded, please purchase separately.
Please specify boring head and insert seat size.

交货方式：不包括刀片，请单独购买。
请注明镗头和镗座尺寸。

BORING



Twin Cutter Rough Boring Head, SP/SC

双刃粗镗刀

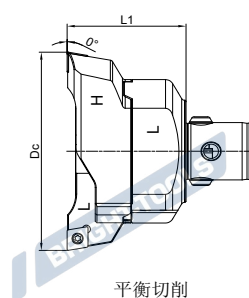
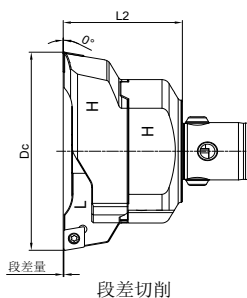

Size	Boring Body	Dc	Insert Seat	L	L2	Step	Insert	Screw	Wrench
DCK1-R2026-SP06	DCK1-R2026	20-26	R2026-SP06-H	33	33.1	0.2	SP06	M2.2X6	T8
		20-26	R2026-SP06-L	33	33.1	0.2	SP06	M2.2X6	T8
DCK2-R2533-SP06	DCK2-R2533	25-33	R2533-SP06-H	36	36.1	0.2	SP06	M2.2X6	T8
		25-33	R2533-SP06-L	36	36.1	0.2	SP06	M2.2X6	T8
DCK3-R3242-SC09	DCK3-R3242	32-42	R3242-SC09-H	40	40.2	0.4	SC09	M4.0X10	T15
		32-42	R3242-SC09-L	40	40.2	0.4	SC09	M4.0X10	T15
DCK4-R4154-SC09	DCK4-R4154	41-54	R4154-SC09-H	47	47.2	0.4	SC09	M4.0X10	T15
		41-54	R4154-SC09-L	47	47.2	0.4	SC09	M4.0X10	T15
DCK5-R5370-SC09	DCK5-R5370	53-70	R5370-SC09-H	58	58.2	0.4	SC09	M4.0X10	T15
		53-70	R5370-SC09-L	58	58.2	0.4	SC09	M4.0X10	T15
DCK6-R6890-SC12	DCK6-R68110	68-90	R6890-SC12-H	72	72.2	0.4	SC12	M5.0X12	T20
		68-90	R6890-SC12-L	72	72.2	0.4	SC12	M5.0X12	T20
DCK6-R88110-SC12	DCK6-R68110	88-110	R88110-SC12-H	72	72.2	0.4	SC12	M5.0X12	T20
		88-110	R88110-SC12-L	72	72.2	0.4	SC12	M5.0X12	T20
DCK6-R98126-SC12	DCK6-R98153	98-126	R98126-SC12-H	72	72.2	0.4	SC12	M5.0X12	T20
		98-126	R98126-SC12-L	72	72.2	0.4	SC12	M5.0X12	T20
DCK6-R125153-SC12	DCK6-R98153	125-153	R125153-SC12-H	72	72.2	0.4	SC12	M5.0X12	T20
		125-153	R125153-SC12-L	72	72.2	0.4	SC12	M5.0X12	T20
DCK7-R150204-SC12	DCK7-R150204	150-204	R150204-SC12-H	117	117.2	0.4	SC12	M5.0X12	T20
		150-204	R150204-SC12-L	117	117.2	0.4	SC12	M5.0X12	T20
DCK7-R175203-SC12	DCK7-R150204	175-203	R175203-SC12-H	117	117.2	0.4	SC12	M5.0X12	T20
		175-203	R175203-SC12-L	117	117.2	0.4	SC12	M5.0X12	T20

Cooling: boring head with internal cooling

Order: please specify boring head and insert seat size.

Inserts excluded, please purchase separately.

Usage: connect with boring tool holder for rough boring operation.

冷却: 镗头带内部冷却

订购: 请注明镗头和刀片座尺寸。

刀片不包括在内, 请单独购买。

用途: 与镗刀架连接, 用于粗镗操作。

Twin Cutter Rough Boring Head, CC 双刃粗镗刀

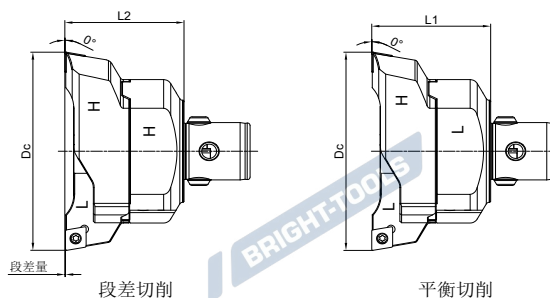

Size	Boring Body	Dc	Insert Seat	L	L2	Step	Insert	Screw	Wrench
DCK1-R2026-CC06	DCK1-R2026	20-26	R2026-CC06-H	33	33.1	0.2	CC06	M2.2X6	T8
		20-26	R2026-CC06-L	33	33.1	0.2	CC06	M2.2X6	T8
DCK2-R2533-CC06	DCK2-R2533	25-33	R2533-CC06-H	36	36.1	0.2	CC06	M2.2X6	T8
		25-33	R2533-CC06-L	36	36.1	0.2	CC06	M2.2X6	T8
DCK3-R3242--CC09	DCK3-R3242	32-42	R3242-CC09-H	40	40.2	0.2	CC09	M4.0X10	T15
		32-42	R3242-CC09-L	40	40.2	0.2	CC09	M4.0X10	T15
DCK4-R4154-CC09	DCK4-R4154	41-54	R4154-CC09-H	47	47.2	0.4	CC09	M4.0X10	T15
		41-54	R4154-CC09-L	47	47.2	0.4	CC09	M4.0X10	T15
DCK5-R5370-CC09	DCK5-R5370	53-70	R5370-CC09-H	58	58.2	0.4	CC09	M4.0X10	T15
		53-70	R5370-CC09-L	58	58.2	0.4	CC09	M4.0X10	T15
DCK6-R6890-CC12	DCK6-R68110	68-90	R6890-CC12-H	72	72.2	0.4	CC12	M5.0X12	T20
		68-90	R6890-CC12-L	72	72.2	0.4	CC12	M5.0X12	T20
DCK6-R88110-CC12	DCK6-R68110	88-110	R88110-CC12-H	72	72.2	0.4	CC12	M5.0X12	T20
		88-110	R88110-CC12-L	72	72.2	0.4	CC12	M5.0X12	T20
DCK6-R98126-CC12	DCK6-R98153	98-126	R98126-CC12-H	72	72.2	0.4	CC12	M5.0X12	T20
		98-126	R98126-CC12-L	72	72.2	0.4	CC12	M5.0X12	T20
DCK6-R125153-CC12	DCK6-R98153	125-153	R125153-CC12-H	72	72.2	0.4	CC12	M5.0X12	T20
		125-153	R125153-CC12-L	72	72.2	0.4	CC12	M5.0X12	T20
DCK7-R148176-CC12	DCK7-R148203	148-176	R148176-CC12-H	117	117.2	0.4	CC12	M5.0X12	T20
		148-176	R148176-CC12-L	117	117.2	0.4	CC12	M5.0X12	T20
DCK7-R175203-CC12	DCK7-R148203	175-203	R175203-CC12-H	117	117.2	0.4	CC12	M5.0X12	T20
		175-203	R175203-CC12-L	117	117.2	0.4	CC12	M5.0X12	T20

Cooling: boring head with internal cooling

Order: please specify boring head and insert seat size.

Inserts excluded, please purchase separately.

Usage: connect with boring tool holder for rough boring operation.

冷却：镗头带内部冷却

订购：请注明镗头和刀片座尺寸。

刀片不包括在内，请单独购买。

用途：与镗刀架连接，用于粗镗操作。

Bridge Fine Boring Head, Standard

桥式精镗刀, 标准钢制

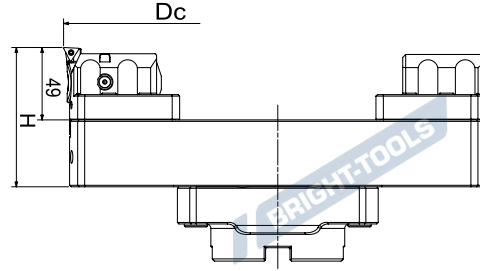

Size	Dc	Flange Seat	Bridge	Boring Slide	Balance Block	Insert Seat	H	Insert	Cooling	Weight (kg)
BF200308-TC11	200-282	SL-135-40	SL200290	BF-78	BF-73	F6-1	94	TC1102	INT	6.6
BF290398-TC11	290-372	SL-135-40	SL290380	BF-78	BF-73	F6-1	94	TC1102	INT	8.8
BF380488-TC11	380-462	SL-135-40	SL380470	BF-78	BF-73	F6-1	94	TC1102	INT	11.0
BF470578-TC11	470-552	SL-135-40	SL470560	BF-78	BF-73	F6-1	99	TC1102	EXT	14.1
BF560668-TC11	560-642	SL-235-60	SL560650	BF-78	BF-73	F6-1	99	TC1102	EXT	16.7
BF650758-TC11	650-732	SL-235-60	SL650740	BF-78	BF-73	F6-1	104	TC1102	EXT	20.9
BF740848-TC11	740-812	SL-235-60	SL740830	BF-78	BF-73	F6-1	109	TC1102	EXT	23.4

Bridge Fine Boring Head, Light

桥式精镗刀, 轻型铝制

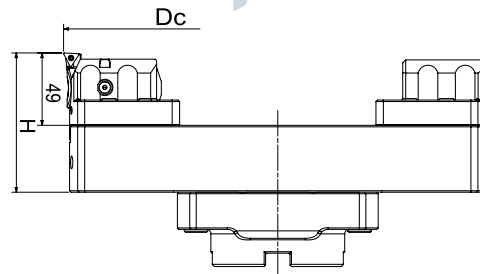

Size	Dc	Flange Seat	Bridge	Boring Slide	Balance Block	Insert Seat	H	Insert	Cooling	Weight (kg)
BF200308AL-TC11	200-282	SL-135-40	SL200290-AL	BF-78	BF-73	F6-1	94	TC1102	INT	4.2
BF290380AL-TC11	290-372	SL-135-40	SL290380-AL	BF-78	BF-73	F6-1	94	TC1102	INT	5.0
BF380470AL-TC11	380-462	SL-135-40	SL380470-AL	BF-78	BF-73	F6-1	94	TC1102	INT	5.8
BF470578AL-TC11	470-552	SL-135-40	SL470560-AL	BF-78	BF-73	F6-1	99	TC1102	EXT	6.9
BF560668AL-TC11	560-642	SL-235-60	SL560650-AL	BF-78	BF-73	F6-1	99	TC1102	EXT	7.8
BF650758AL-TC11	650-732	SL-235-60	SL650740-AL	BF-78	BF-73	F6-1	104	TC1102	EXT	9.3
BF740848AL-TC11	740-812	SL-235-60	SL740830-AL	BF-78	BF-73	F6-1	109	TC1102	EXT	11.0

Delivery: insert excluded, please purchase separately.
 交货方式: 不含刀片, 请单独购买。

Bridge Rough Boring Head, Standard

桥式双刃粗镗刀, 标准钢制

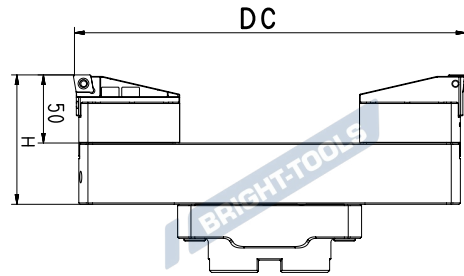

Size	Dc	Flange Seat	Bridge	Clamp Base	Insert Seat	H	Insert	Cooling	Weight (kg)
BR200290-CC12	200-290	SL-135-40	BR200290	BR-73	BR90-CC12	95	CC1204	INT	6.2
BR290380-CC12	290-380	SL-135-40	BR290380	BR-73	BR90-CC12	95	CC1204	INT	8.4
BR380470-CC12	380-470	SL-135-40	BR380470	BR-73	BR90-CC12	95	CC1204	INT	10.6
BR470560-CC12	470-560	SL-135-40	BR470560	BR-73	BR90-CC12	100	CC1204	EXT	14
BR470610-CC12	470-610	SL-235-60	BR470560	BR-123	BR90-CC12	100	CC1204	EXT	15
BR560650-CC12	560-650	SL-235-60	BR560650	BR-73	BR90-CC12	100	CC1204	EXT	16.5
BR560700-CC12	560-700	SL-235-60	BR560650	BR-123	BR90-CC12	100	CC1204	EXT	17.5
BR650740-CC12	650-740	SL-235-60	BR650740	BR-73	BR90-CC12	105	CC1204	EXT	20.5
BR650790-CC12	650-790	SL-235-60	BR650740	BR-123	BR90-CC12	105	CC1204	EXT	21.5
BR740830-CC12	740-830	SL-235-60	BR740830	BR-73	BR90-CC12	110	CC1204	EXT	23.8
BR740880-CC12	740-880	SL-235-60	BR740830	BR-123	BR90-CC12	110	CC1204	EXT	24.8

Size	Dc	Flange Seat	Bridge	Clamp Base	Insert Seat	H	Insert	Cooling	Weight (kg)
BR200290-SC12	200-290	SL-135-40	BR200290	BR-73	BR86-SC12	95	SC1204	INT	6.2
BR290380-SC12	290-380	SL-135-40	BR290380	BR-73	BR86-SC12	95	SC1204	INT	8.4
BR380470-SC12	380-470	SL-135-40	BR380470	BR-73	BR86-SC12	95	SC1204	INT	10.6
BR470560-SC12	470-560	SL-135-40	BR470560	BR-73	BR86-SC12	100	SC1204	EXT	14
BR470610-SC12	470-610	SL-235-60	BR470560	BR-123	BR86-SC12	100	SC1204	EXT	15
BR560650-SC12	560-650	SL-235-60	BR560650	BR-73	BR86-SC12	100	SC1204	EXT	16.5
BR560700-SC12	560-700	SL-235-60	BR560650	BR-123	BR86-SC12	100	SC1204	EXT	17.5
BR650740-SC12	650-740	SL-235-60	BR650740	BR-73	BR86-SC12	105	SC1204	EXT	20.5
BR650790-SC12	650-790	SL-235-60	BR650740	BR-123	BR86-SC12	105	SC1204	EXT	21.5
BR740830-SC12	740-830	SL-235-60	BR740830	BR-73	BR86-SC12	110	SC1204	EXT	23.8
BR740880-SC12	740-880	SL-235-60	BR740830	BR-123	BR86-SC12	110	SC1204	EXT	24.8



Bridge Rough Boring Head, Light

桥式双刃粗镗刀, 轻型铝制

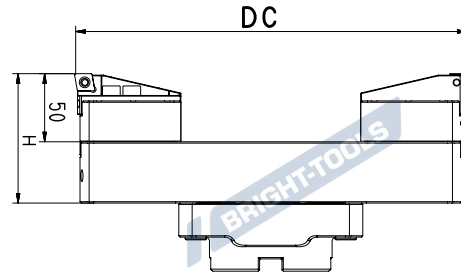

Size	Dc	Flange Seat	Bridge	Clamp Base	Insert Seat	H	Insert	Cooling	Weight (kg)
BR200290AL-CC12	200-290	SL-135-40	BR200290-AL	BR-73-AL	BR90-CC12	95	CC1204	INT	3.2
BR290380AL-CC12	290-380	SL-135-40	BR290380-AL	BR-73-AL	BR90-CC12	95	CC1204	INT	3.96
BR380470AL-CC12	380-470	SL-135-40	BR380470-AL	BR-73-AL	BR90-CC12	95	CC1204	INT	4.76
BR470560AL-CC12	470-560	SL-135-40	BR470560-AL	BR-73-AL	BR90-CC12	100	CC1204	EXT	5.86
BR470610AL-CC12	470-610	SL-235-60	BR470560-AL	BR-123-AL	BR90-CC12	100	CC1204	EXT	6.36
BR560650AL-CC12	560-650	SL-235-60	BR560650-AL	BR-73-AL	BR90-CC12	100	CC1204	EXT	6.81
BR560700AL-CC12	560-700	SL-235-60	BR560650-AL	BR-123-AL	BR90-CC12	100	CC1204	EXT	7.31
BR650740AL-CC12	650-740	SL-235-60	BR650740-AL	BR-73-AL	BR90-CC12	105	CC1204	EXT	8.3
BR650790AL-CC12	650-790	SL-235-60	BR650740-AL	BR-123-AL	BR90-CC12	105	CC1204	EXT	8.8
BR740830AL-CC12	740-830	SL-235-60	BR740830-AL	BR-73-AL	BR90-CC12	110	CC1204	EXT	9.96
BR740880AL-CC12	740-880	SL-235-60	BR740830-AL	BR-123-AL	BR90-CC12	110	CC1204	EXT	10.46

Size	Dc	Flange Seat	Bridge	Clamp Base	Insert Seat	H	Insert	Cooling	Weight (kg)
BR200290AL-SC12	200-290	SL-135-40	BR200290-AL	BR-73-AL	BR86-SC12	95	SC1204	INT	3.2
BR290380AL-SC12	290-380	SL-135-40	BR290380-AL	BR-73-AL	BR86-SC12	95	SC1204	INT	3.96
BR380470AL-SC12	380-470	SL-135-40	BR380470-AL	BR-73-AL	BR86-SC12	95	SC1204	INT	4.76
BR470560AL-SC12	470-560	SL-135-40	BR470560-AL	BR-73-AL	BR86-SC12	100	SC1204	EXT	5.86
BR470610AL-SC12	470-610	SL-235-60	BR470560-AL	BR-123-AL	BR86-SC12	100	SC1204	EXT	6.36
BR560650AL-SC12	560-650	SL-235-60	BR560650-AL	BR-73-AL	BR86-SC12	100	SC1204	EXT	6.81
BR560700AL-SC12	560-700	SL-235-60	BR560650-AL	BR-123-AL	BR86-SC12	100	SC1204	EXT	7.31
BR650740AL-SC12	650-740	SL-235-60	BR650740-AL	BR-73-AL	BR86-SC12	105	SC1204	EXT	8.3
BR650790AL-SC12	650-790	SL-235-60	BR650740-AL	BR-123-AL	BR86-SC12	105	SC1204	EXT	8.8
BR740830AL-SC12	740-830	SL-235-60	BR740830-AL	BR-73-AL	BR86-SC12	110	SC1204	EXT	9.96
BR740880AL-SC12	740-880	SL-235-60	BR740830-AL	BR-123-AL	BR86-SC12	110	SC1204	EXT	10.46

OD Turning Holders

外镗

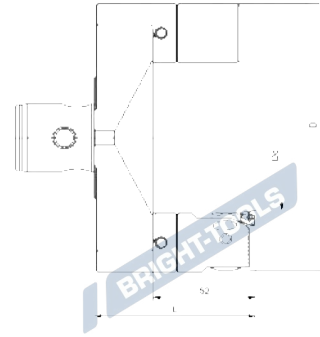

Size	CK No.	Dc	D	L	F	平衡块	Insert Seat	Insert
CK6-CK3-2552-42	CK6	25-34	φ117	82	CK3-F3260	CK3-F3137	F3-1	TP08
	CK6	34-43	φ117	82	CK3-F3260	CK3-F3137	F3-2	TP08
	CK6	43-52	φ117	82	CK3-F3260	CK3-F3137	F3-3	TP08
CK6-CK3-5077-42	CK6	50-59	φ142	82	CK3-F3260	CK3-F3137	F3-1	TP08
	CK6	59-68	φ142	82	CK3-F3260	CK3-F3137	F3-2	TP08
	CK6	68-77	φ142	82	CK3-F3260	CK3-F3137	F3-3	TP08
CK6-CK3-75102-42	CK6	75-84	φ167	82	CK3-F3260	CK3-F3137	F3-1	TP08
	CK6	84-93	φ167	82	CK3-F3260	CK3-F3137	F3-2	TP08
	CK6	93-102	φ167	82	CK3-F3260	CK3-F3137	F3-3	TP08
CK6-CK3-100127-42	CK7	100-109	φ192	87	CK3-F3260	CK3-F3137	F3-1	TP08
	CK7	109-118	φ192	87	CK3-F3260	CK3-F3137	F3-2	TP08
	CK7	118-127	φ192	87	CK3-F3260	CK3-F3137	F3-3	TP08
CK6-CK3-125152-42	CK7	125-134	φ217	87	CK3-F3260	CK3-F3137	F3-1	TP08
	CK7	134-143	φ217	87	CK3-F3260	CK3-F3137	F3-2	TP08
	CK7	143-152	φ217	87	CK3-F3260	CK3-F3137	F3-3	TP08



Small Fine Boring Head

精镗小刀夹

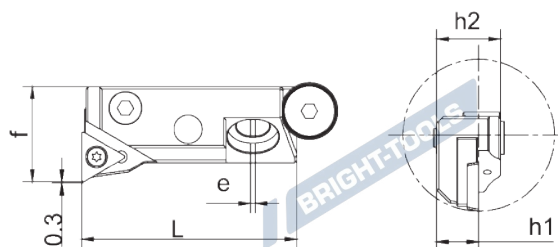

Size	Degree	Dmin	L	h1	h2	e	f	r	Insert
DF-1695L-CC06	95	28	45.5	8.8	13.5	1	16	0.4	CC..0602..
DF-1695R-CC06	95	28	45.5	8.8	13.5	1	16	0.4	CC..0602..
DF-1695L-TP09	95	28	45.5	8.8	13.5	1	16	0.4	TP..0902..
DF-1695R-TP09	95	28	45.5	8.8	13.5	1	16	0.4	TP..0902..
DF-2095L-TC11	95	36	45.5	8.8	13.5	1	20	0.4	TC..1102..
DF-2095R-TC11	95	36	45.5	8.8	13.5	1	20	0.4	TC..1102..
DF-2095L-TP11	95	36	45.5	8.8	13.5	1	20	0.4	TP..1102..
DF-2095R-TP11	95	36	45.5	8.8	13.5	1	20	0.4	TP..1102..
DF-1690L-CC06	90	28	45.5	8.8	13.5	1	16	0.4	CC..0602..
DF-1690R-CC06	90	28	45.5	8.8	13.5	1	16	0.4	CC..0602..
DF-1690L-TP09	90	28	45.5	8.8	13.5	1	16	0.4	TP..0902..
DF-1690R-TP09	90	28	45.5	8.8	13.5	1	16	0.4	TP..0902..
DF-2090L-TC11	90	36	45.5	8.8	13.5	1	20	0.4	TC..1102..
DF-2090R-TC11	90	36	45.5	8.8	13.5	1	20	0.4	TC..1102..
DF-2090L-TP11	90	36	45.5	8.8	13.5	1	20	0.4	TP..1102..
DF-2090R-TP11	90	36	45.5	8.8	13.5	1	20	0.4	TP..1102..

Delivery: insert excluded, please purchase separately.

Usage: mainly used to connect with special tool holders.

交货方式: 不含刀片, 请单独购买。

用途: 主要用于连接专用工具夹头。

Fine Boring Unit 精镗单元

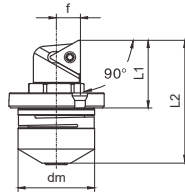

Type 1

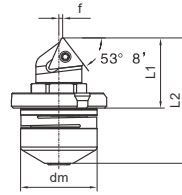

Type 2

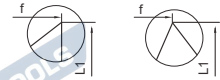

刀尖圆弧r=0
Tip diameter r=0

Size		Angle	dm	L	L1	f	Dmin	Insert	Weight	Type
Left	Right									
FB-A16-CC06L	FB-A16-CC06R	90	16	24.1	13.3	5.1	27	CC..060204	0.02	1
FB-A16-TB06L	FB-A16-TB06R	90	16	24.1	13.3	5.1	27	TB..060102	0.02	1
FB-A20-TC09L	FB-A20-TC09R	90	20	32.9	18.3	6.3	36.5	TC..090204	0.05	1
FB-A20-TP09L	FB-A20-TP09R	90	20	32.9	18.3	6.3	36.5	TP..090204	0.05	1
FB-A22-TC11L	FB-A22-TC11R	90	22	44.3	22.1	7.2	48.5	TC..110204	0.1	1
FB-A22-TP11L	FB-A22-TP11R	90	22	44.3	22.1	7.2	48.5	TP..110304	0.1	1
FB-A32-TC16L	FB-A32-TC16R	90	32	62.7	32	10.3	68.4	TC..16T308	0.29	1
FB-A32-TP11L	FB-A32-TP11R	90	32	62.7	32	10.3	68.4	TP..110304	0.29	1
FB-B16-CC06L	FB-B16-CC06R	53°8'	16	25.15	14.3	0.45	25.2	CC..060204	0.02	2
FB-B16-TB06L	FB-B16-TB06R	53°8'	16	25	14.3	0.2	24.8	TB..060102	0.02	2
FB-B20-TC09L	FB-B20-TC09R	53°8'	20	33.7	19.1	0.9	32.5	TC..090204	0.05	2
FB-B20-TP09L	FB-B20-TP09R	53°8'	20	33.7	19.1	0.9	32.5	TP..090204	0.05	2
FB-B22-TC11L	FB-B22-TC11R	53°8'	22	45.3	23	1.1	42	TC..110204	0.1	2
FB-B22-TP11L	FB-B22-TP11R	53°8'	22	45.3	23	1.1	42	TP..110304	0.1	2
FB-B32-TC16L	FB-B32-TC16R	53°8'	32	62.3	33.3	1.2	59.4	TC..16T308	0.29	2
FB-B32-TP11L	FB-B32-TP11R	53°8'	32	62.3	33.3	1.2	59.4	TP..110304	0.29	2



NBJ16 Fine Boring Head With Small Bore

NBJ16 小孔径精镗头

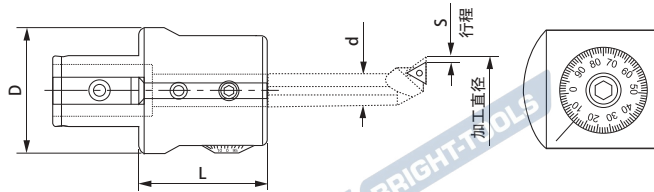

Size	DCK No.	Dc	D	d	L	S	Dial precision	Wrench	Weight
NBJ16	6	6-50	64	16	50	5	0.01	T05	1.14

NBJ16 Micro-Boring Bar

NBJ16 微调精密镗头刀杆

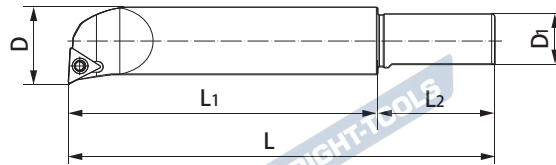

Size	D	D1	L1	L2	L	Dc	Insert	Insert screw	Wrench	Weight
NBJ1606-24	6	16	24	34	66	6-8	WBGT0601	M2*4	T06	0.07
NBJ1608-32	8	16	32	34	76	8-11	TBGT0601	M2*4	T06	0.06
NBJ1610-40	10	16	40	34	77	10-13	TBGT0601	M2*4	T06	0.07
NBJ1612-53	12	16	53	34	90	12-17	TPGH0902	M2.5*6	T08	0.09
NBJ1616-68	16	16	68	34	102	16-21	TPGH0902	M2.5*6	T08	0.13
NBJ1620-83	20	16	83	34	120	20-26	TPGH1103	M3*7	T10	0.2
NBJ1625-90	25	16	90	34	124	25-32	TPGH1103	M3*7	T10	0.25
NBJ1630-90	30	16	90	34	124	30-42	TPGH1103	M3*7	T10	0.25
NBJ1640-90	40	16	90	34	124	40-50	TPGH1103	M3*7	T10	0.26

NBJ16 Micro-Boring Tool Kit NBJ16 微调精镗套装组合



Size	Boring Adapter	Boring Head	Boring Bar	DC	Weight
BT40-NBJ16-8PCS	BT40-DCK6-55	NBJ16	NBJ1608-32	8-50	3.68
			NBJ1610-40		
			NBJ1612-53		
			NBJ1616-68		
			NBJ1620-83		
			NBJ1625-90		
			NBJ1630-90		
			NBJ1640-90		
BT50-NBJ16-8PCS	BT40-DCK6-55	NBJ16	NBJ1608-32	8-50	6.74
			NBJ1610-40		
			NBJ1612-53		
			NBJ1616-68		
			NBJ1620-83		
			NBJ1625-90		
			NBJ1630-90		
			NBJ1640-90		

Items Included

1. One boring adapter
2. One micro boring head
3. Eight micro boring bars
4. Three wrenches

内附零件

1. 刀柄一支
2. 精密镗头一支
3. 精镗刀杆八支
4. 扳手三把

NBH2084 Micro-Boring Head

NBH2084 微调精密镗头

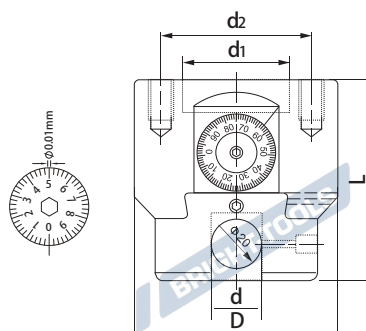

Size	D	d	d1	d2	L	Dc	Micro Distance	Wrench	Dial Precision	Adapter	Wrench	Weight
NBH2084	84	20	35	60	80	8-280	28	T04	0.01	NBH-A.B	T06	2.74

NBJ20 Micro-Boring Bar

NBJ20 微调精密镗头刀杆

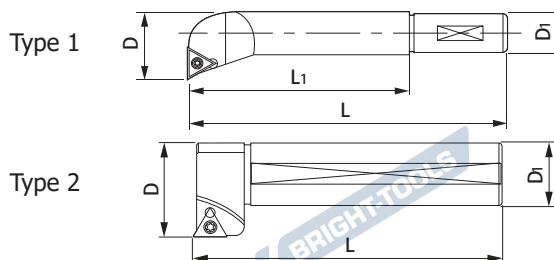
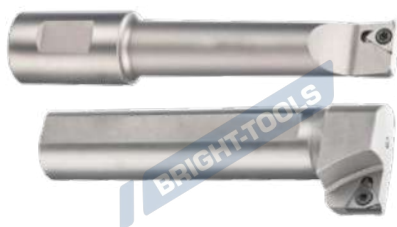

Size	Type	D	D1	L1	L	Dc	Insert	Insert screw	Wrench	Weight
NBJ2008-32	1	8	20	32	74	8-11	TBGT0601	M2*4	T06	0.09
NBJ2010-40	1	10	20	40	75	10-13	TBGT0601	M2*4	T06	0.1
NBJ2012-53	1	12	20	53	88	12-17	TPGH0902	M2.5*6	T10	0.12
NBJ2016-68	1	16	20	68	103	16-21	TPGH0902	M2.5*6	T10	0.16
NBJ2020-83	1	20	20	83	115	20-26	TPGH1103	M3*7	T10	0.22
NBJ2025-96	1	25	20	96	131	25-135	TPGH1103	M3*7	T10	0.35
NBJ2030-115	1	30	20	115	159	30-140	TPGH1103	M3*7	T10	0.52
NBJ20120-97	2	30	20	-	97	120-280	TPGH1103	M3*7	T10	0.25

NBH2084 Boring Tool Kit

NBH2084 精镗套装组合



Size	Boring Adapter	Boring Head	Boring Bar	Dc	Weight
BT40-NBH2084-8PCS	BT40-NBH-A50	NBJ20	NBJ2008-32	8-280	6.44
			NBJ2010-40		
			NBJ2012-53		
			NBJ2016-68		
			NBJ2020-83		
			NBJ2025-96		
			NBJ2030-115		
			NBJ20120-97		
BT50-NBH2084-8PCS	BT50-NBH-A50	NBJ20	NBJ2008-32	8-280	8.89
			NBJ2010-40		
			NBJ2012-53		
			NBJ2016-68		
			NBJ2020-83		
			NBJ2025-96		
			NBJ2030-115		
			NBJ20120-97		

Items Included

1. One boring adapter
2. One micro boring head
3. Eight micro boring bars
4. Four wrenches

内附零件

1. 刀柄一支
2. 精密镗头一支
3. 精镗刀杆八支
4. 扳手四把

DCK5-FB50P Micro-Nishing Boring Kit

DCK5-FB50P 极细微调精镗孔系统



Size	L1	Dc	Adapter	Wrench	Weigit
BT30-DCK5-FB50P	80	6-80	BT30-DCK5-70	L05	2.9
BT40-DCK5-FB50P	80	6-80	BT40-DCK5-80	L05	3.54
BT50-DCK5-FB50P	80	6-80	BT50-DCK5-90	L05	6.32
SK40-DCK5-FB50P	90	6-80	SK40-DCK5-80	L05	3.54
SK50-DCK5-FB50P	90	6-80	SK50-DCK5-90	L05	6.32
HSK63A-DCK5-FB50P	70	6-80	HSK63A--DCK5-80	L05	4.02

Size	Dc	DM	Insert	Weigit
F1606-21	6-9	21	WBGT0601..L	0.04
F1608-28	8-11	28	TBGT0601..L	0.04
F1610-35	10-13	35	TBGT0601..L	0.05
F1612-42	12-15	42	TPGH0902..L	0.06
F1614-50	14-17	50	TPGH0902..L	0.07
F1616-60	16-20	60	TPGH0902..L	0.09
F1620-65	20-24	65	TPGH0902..L	0.11
F1624-68	24-28	68	TPGH0902..L	0.12
FM5	60+FM2938TP or FM3652TP or FM4868TP			0.25
FM2938TP	28-38	11	TPGH0902..L	0.01
FM3652TP	36-52	13	TPGH1103..L	0.02
FM4868TP	48-68	13	TPGH1103..L	0.03
FM8	+FM5780TP			0.03
FM5780TP	57-80	+20	TPGH1103..L	0.1

DCK6-FB63P Micro-Nishing Boring Kit DCK6-FB63P 极细微调精镗孔系统



Size	L1	Dc	Adapter	Wrench	Weigit
BT30-DCK6-FB63P	60	6-150	BT30-DCK6-60	L05	4
BT40-DCK6-FB63P	55	6-150	BT40-DCK6-55	L05	4.5
BT50-DCK6-FB63P	85	6-150	BT50-DCK6-85	L05	9.17
SK40-DCK6-FB63P	90	6-150	SK40-DCK6-90	L05	4.5
SK50-DCK6-FB63P	85	6-150	SK50-DCK6-85	L05	9.17
HSK63A-DCK6-FB63P	100	6-150	HSK63A-DCK6-100	L05	5.9

Size	Dc	DM	Insert	Weigit
F1606-21	6-9	21	WBGTO601..L	0.04
F1608-28	8-11	28	TBGT0601..L	0.04
F1610-35	10-13	35	TBGT0601..L	0.05
F1612-42	12-15	42	TPGH0902..L	0.06
F1614-50	14-17	50	TPGH0902..L	0.07
F1616-60	16-20	60	TPGH0902..L	0.09
F1620-65	20-24	65	TPGH0902..L	0.11
F1624-68	24-28	68	TPGH0902..L	0.12
FM5	60+FM2938TP or FM3652TP or FM4868TP			0.25
FM2938TP	28-38	+11	TPGH0902..L	0.01
FM3652TP	36-52	+13	TPGH0902..L	0.02
FM4868TP	48-68	+13	TPGH0902..L	0.03
FM8	+FM5780TP or FM70110TP or FM110150TP			0.03
FM5780TP	66-80	+20	TPGH1103..L	0.1
FM70110TP	70-110	+20	TPGH1103..L	0.1
FM110150TP	110-150	+20	TPGH1103..L	0.21

Boring Tool Holder Set

镗刀柄套装



Size	Boring Tool Holder	Fine Boring	Rough Boring	Insert Seat
BT40-DCK1-70 SET	BT40-DCK1-70	DCK1-R2026	DCK1-F2036	F1-1,F1-2,F1-3
BT40-DCK2-75 SET	BT40-DCK2-75	DCK2-R2533	DCK2-F2547	F2-1,F2-2,F2-3
BT40-DCK3-80 SET	BT40-DCK3-80	DCK3-R3242	DCK3-F3260	F3-1,F3-2,F3-3
BT40-DCK4-70 SET	BT40-DCK4-70	DCK4-R4154	DCK4-F4147	F4-1,F4-2,F4-3
BT40-DCK5-80 SET	BT40-DCK5-80	DCK5-R5370	DCK5-F5395	F5-1,F5-2,F5-3
BT40-DCK6-100 SET	BT40-DCK6-100	DCK6-R6890	DCK6-F68150	F6-1,F6-2,F6-3
BT50-DCK1-80 SET	BT50-DCK1-80	DCK1-R2026	DCK1-F2036	F1-1,F1-2,F1-3
BT50-DCK2-85 SET	BT50-DCK2-85	DCK2-R2533	DCK2-F2547	F2-1,F2-2,F2-3
BT50-DCK3-85 SET	BT50-DCK3-85	DCK3-R3242	DCK3-F3260	F3-1,F3-2,F3-3
BT50-DCK4-100 SET	BT50-DCK4-100	DCK4-R4154	DCK4-F4147	F4-1,F4-2,F4-3
BT50-DCK5-90 SET	BT50-DCK5-90	DCK5-R5370	DCK5-F5395	F5-1,F5-2,F5-3
BT50-DCK6-85 SET	BT50-DCK6-85	DCK6-R6890	DCK6-F6890	F6-1,F6-2,F6-3
SK40-DCK1-70 SET	SK40-DCK1-70	DCK1-R2026	DCK1-F2036	F1-1,F1-2,F1-3
SK40-DCK2-75 SET	SK40-DCK2-75	DCK2-R2533	DCK2-F2547	F2-1,F2-2,F2-3
SK40-DCK3-50 SET	SK40-DCK3-50	DCK3-R3242	DCK3-F3260	F3-1,F3-2,F3-3
SK40-DCK4-50 SET	SK40-DCK4-50	DCK4-R4154	DCK4-F4147	F4-1,F4-2,F4-3
SK40-DCK5-80 SET	SK40-DCK5-80	DCK5-R5370	DCK5-F5395	F5-1,F5-2,F5-3
SK40-DCK6-90 SET	SK40-DCK6-90	DCK6-R6890	DCK6-F6890	F6-1,F6-2,F6-3
SK50-DCK1-80 SET	SK50-DCK1-80	DCK1-R2026	DCK1-F2036	F1-1,F1-2,F1-3
SK50-DCK2-85 SET	SK50-DCK2-85	DCK2-R2533	DCK2-F2547	F2-1,F2-2,F2-3
SK50-DCK3-85 SET	SK50-DCK3-85	DCK3-R3242	DCK3-F3260	F3-1,F3-2,F3-3
SK50-DCK4-70 SET	SK50-DCK4-70	DCK4-R4154	DCK4-F4147	F4-1,F4-2,F4-3
SK50-DCK5-80 SET	SK50-DCK5-80	DCK5-R5370	DCK5-F5395	F5-1,F5-2,F5-3
SK50-DCK6-85 SET	SK50-DCK6-85	DCK6-R6890	DCK6-F6890	F6-1,F6-2,F6-3

Boring Tool Holder Set

镗刀柄套装



Size	Boring Tool Holder	Fine Boring	Rough Boring	Insert Seat
HSK63A-DCK1-70 SET	HSK63A-DCK1-70	DCK1-F2026	DCK1-R2036	F1-1,F1-2,F1-3
HSK63A-DCK2-75 SET	HSK63A-DCK2-75	DCK2-F2547	DCK2-R2533	F2-1,F2-2,F2-3
HSK63A-DCK3-80 SET	HSK63A-DCK3-80	DCK3-F3260	DCK3-R3242	F3-1,F3-2,F3-3
HSK63A-DCK4-70 SET	HSK63A-DCK4-70	DCK4-F4147	DCK4-R4154	F4-1,F4-2,F4-3
HSK63A-DCK5-80 SET	HSK63A-DCK5-80	DCK5-F5395	DCK5-R5370	F5-1,F5-2,F5-3
HSK63A-DCK6-100 SET	HSK63A-DCK6-100	DCK6-F6890	DCK6-R6890	F6-1,F6-2,F6-3
HSK100A-DCK1-115 SET	HSK100A-DCK1-115	DCK1-F2026	DCK1-R2036	F1-1,F1-2,F1-3
HSK100A-DCK2-110 SET	HSK100A-DCK2-110	DCK2-F2547	DCK2-R2533	F2-1,F2-2,F2-3
HSK100A-DCK3-110 SET	HSK100A-DCK3-110	DCK3-F3260	DCK3-R3242	F3-1,F3-2,F3-3
HSK100A-DCK4-100 SET	HSK100A-DCK4-100	DCK4-F4147	DCK4-R4154	F4-1,F4-2,F4-3
HSK100A-DCK5-90 SET	HSK100A-DCK5-90	DCK5-F5395	DCK5-R5370	F5-1,F5-2,F5-3
HSK100A-DCK6-85 SET	HSK100A-DCK6-85	DCK6-F6890	DCK6-R6890	F6-1,F6-2,F6-3