

BRIGHT-TOOLS

BRIGHT-TOOLS

TOOL HOLDERS

HSK-T

BRIGHT-TOOLS

BRIGHT-TOOLS

BRIGHT-TOOLS

BRIGHT-TOOLS

BRIGHT-TOOLS

BRIGHT-TOOLS

HSK63T

D

C

L

N

刀柄尺寸
Taper Size

可转位刀片夹紧方式
Insert Clamping Way

可转位刀片形状
Insert Shape

刀杆偏角
Holder Angle

可转位刀片后角
Insert Clearance Angle

HSK63T
HSK100T

C		从上面压紧 Clamp
D		从上面穿孔压紧 Clamp/inserts with center hole
M		从上面用孔压紧 Pin/Clamp
P		杠杆压紧 Pin/Wedge or Lever
S		通过孔拧紧 Screw

C		80°
D		55°
S		90°
V		35°
W		80°

A		90°
B		75°
D		45°
G		90°
H		107.5°
J		93°
L		95°
M		50°
N		62.5°
P		117.5°
Q		107.5°
R		75°
S		45°
U		93°
V		72.5°

B		5°
C		7°
N		0°

HSK

HSK

63T

刀柄款式
Taper



HSK

刀柄尺寸
Taper Size

HSK63T

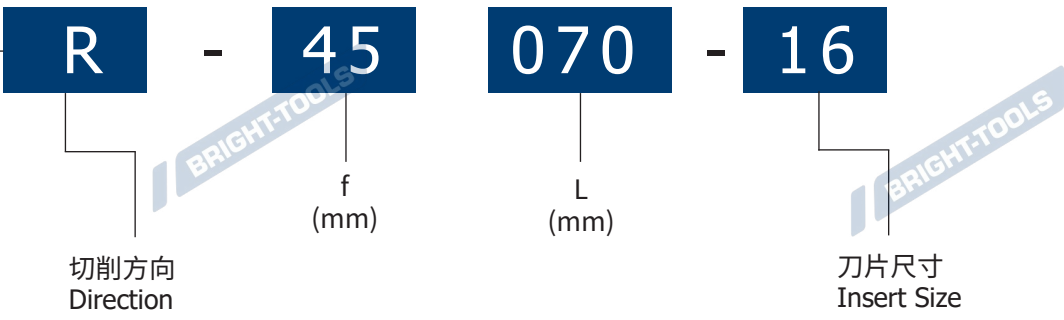
HSK100T



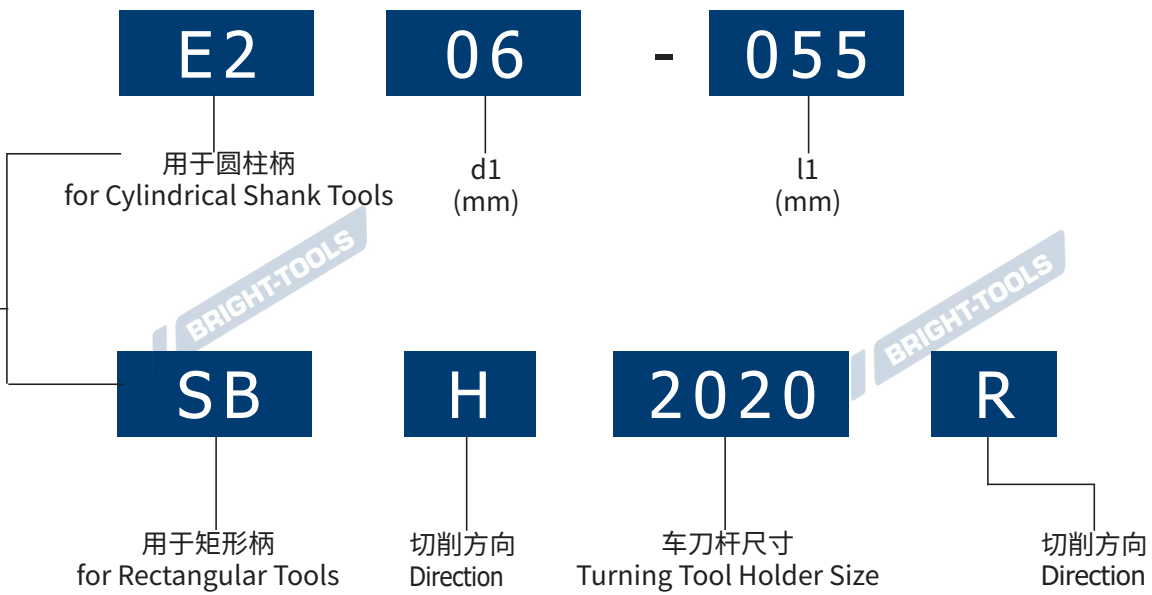

R		右 Right
L		左 Left
N		左右切 Both

HSK



H	00	轴向
N	45	斜向
T		三面
V	90	径向









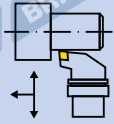
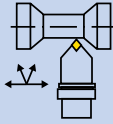
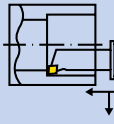

2020	20×20
2525	25×25

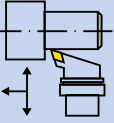
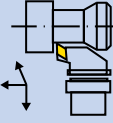
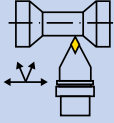
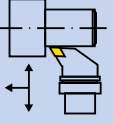
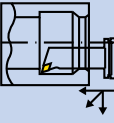
R		右 Right
L		左 Left
N		左右切 Both

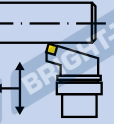
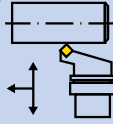

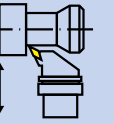
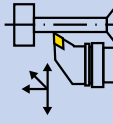
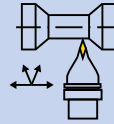
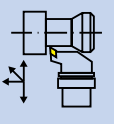

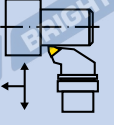
车刀刀体 HSK-T

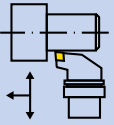
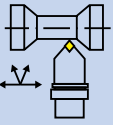
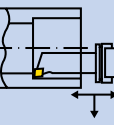
车刀刀体 HSK-T 产品总览

HSK

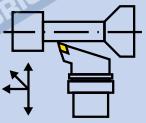
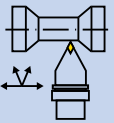
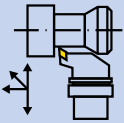
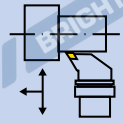
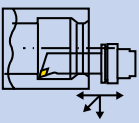
刀片形状 Insert Shape	DCLN PCLN 95° / 80°	DCMNN PCMNN 50° / 80° / 50°	DCLN PCLN 长型 95° / 80°		
C 					
刀片形状 Insert Shape	DDHN PDHN 55° / 93°	DDJN PDJN 55° / 93°	DDNN PDNN 62.5° / 55° / 62.5°	DDUN PDUN 93° / 55°	DDQN PDQN 长型 107.5° / 55°
D 					
刀片形状 Insert Shape	DSBN PSBN 90° / 75°	DSSN PSSN 45° / 90°			
S 					
刀片形状 Insert Shape	DVPCR DVPNL 117.5° / 35°	DVUNR DVUNL 93° / 35°	DVWNN 72.5° / 35° / 72.5°	DVJNR DVJNL 72.5° / 35° / 72.5°	
V 					
刀片形状 Insert Shape	DWLN PWLN 95° / 80°				
W 					
刀片形状 Insert Shape	SCLCR SCLCL 95° / 80°	SCMCN 50° / 80° / 50°	SCLC 长型 95° / 80°		
C 					

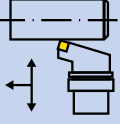
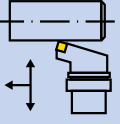
车刀刀体 HSK-T
车刀刀体 HSK-T 产品总览

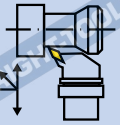
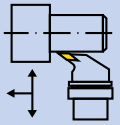
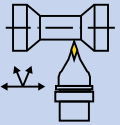
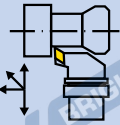
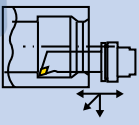
刀片形状 Insert Shape	SDHCR SDHCL 107.5° / 55°	SDNCN 62.5°/55°/62.5°	SDJCR SDJCL 93° / 55°	SDUCR SDUCL 93° / 55°	SDQC 长型 107.5° / 55°
D 					
刀片形状 Insert Shape	SSBCR SSBCL 75° / 90°	SSSCR SSSCL 45° / 90°			
S 					
刀片形状 Insert Shape	SVPB SVPC 117.5° / 35°	SVUB SVUC 93° / 35°	SVVB SVVC 72.5° / 35° / 72.5°	SVJB SVJC 93° / 35°	SVQC 长型 107.5° / 55°
V 					

HSK

BRIGHT-TOOLS

BRIGHT-TOOLS

BRIGHT-TOOLS

BRIGHT-TOOLS

HSK-T TOOLING SYSTEM

HSK-T 工具系统

Boring Bar HolderG.60
复合刀具, 镗孔刀夹

FacingG.61
复合车刀座, 端面加工

External and Facing.....G.61
复合车刀座, 外径端面加工

External and Cut-of-G.....G.62
复合车刀座, 外径切断加工

External and Facing.....G.62
复合车刀座, 外径端面加工

Turning Tool, Negative.....G.63
车刀刀体, 负前角刀片

DCLNR | DCLNL 95°/80°.....G.63

PCLNR | PCLNL 95° /80°G.63

DCMNN 50°/80°/50°.....G.64

PCMNN 50°/80°/50°.....G.64

DDJNR | DDJNL 55°/93°.....G.65

PDJNR | PDJNL 55°/93°.....G.65

DDNNN 62.5°/55°/62.5°.....G.66

PDNNN 62.5°/55°/62.5°.....G.66

DDUNR | DDUNL 93°/55°.....G.66

PDUNR | PDUNL 93°/55°.....G.67

DSBNR | DSBNL 90°/75°.....G.67

PSBNR | PSBNL 90°/75°.....G.67

DSSNR | DSSNL 45°/90°.....G.68

PSSNR | PSSNL 45°/90°.....G.68

DVPNR | DVPNL 117.5°/35°.....G.68

DVUNR | DVUNL 93°/35°.....G.69

DVVNN 72.5°/35°/72.5°.....G.69

DVJNR | DVJNL 93°/35°.....G.69

DWLNR | DWLNL 95°/80°.....G.70

PWLNR | PWLNL 95°/80°.....G.70

Turning Tool, Positive.....G.70
车刀刀体, 正前角刀片

SCLCR | SCLCL 95°/80°.....G.70

SCMCN 50°/80°/50°.....G.71

SDQCR | SDQCL 107.5°/55°.....G.71

SDNCN 62.5°/55°/62.5°.....G.71

SDJCR | SDJCL 93°/55°.....G.72

SDUCR | SDUCL 93°/55°.....G.72

SSBCR | SSBCL 75°/90°.....G.72

SSSCR | SSSCL 45°/90°.....G.73

SVPBR | SVPBL | SVPCR | SVPCL 117.5°/35°.....G.73

SVUBR | SVUBL | SVUCR | SVUCL 93°/35°.....G.74

SVWBN | SVWCN 72.5°/35°/72.5°.....G.74

长型 DCLNR | DCLNL 95°/80°.....G.75

长型 PCLNR | PCLNL 95° /80°G.76

长型 PDQNR | PDQNL 107.5°/55°.....G.76

长型 DDQNR | DDQNL 107.5°/55°.....G.77

长型 SCLCR | SCLCL 95°/80°.....G.77

长型 SVQCR | SVQCL 107.5°/55°.....G.78



HSK-T Boring Bar Holder

复合刀具, 镗孔刀夹

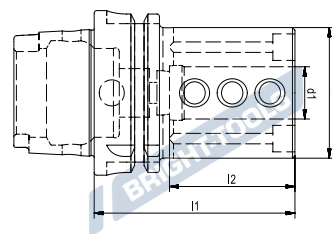

Size	d1	d2	l1	l2
HSK40TAX-E2-08	8	32	60	37
HSK40TAX-E2-10	10	34	60	37
HSK40TAX-E2-12	12	36	65	40
HSK40TAX-E2-16	16	40	70	42
HSK40TAX-E2-20	20	45	70	42
HSK50TAX-E2-10	10	38	75	45
HSK50TAX-E2-12	12	40	75	45
HSK50TAX-E2-16	16	45	80	50
HSK50TAX-E2-20	20	50	80	47
HSK50TAX-E2-25	25	55	85	50
HSK63TAX-E2-06	6	30	65	40
HSK63TAX-E2-08	8	32	70	40
HSK63TAX-E2-10	10	38	75	45
HSK63TAX-E2-12	12	40	75	45
HSK63TAX-E2-16	16	45	80	50
HSK63TAX-E2-20	20	50	80	50
HSK63TAX-E2-25	25	55	85	52
HSK63TAX-E2-32	32	72	108	60
HSK63TAX-E2-40	40	80	120	72
HSK100TAX-E2-16	16	45	85	48
HSK100TAX-E2-20	20	50	85	48
HSK100TAX-E2-25	25	55	85	48
HSK100TAX-E2-32	32	72	95	58
HSK100TAX-E2-40	40	80	110	73
HSK100TAX-E2-50	50	90	120	82

HSK·T Turning Tools for Facing 复合车刀座, 端面加工

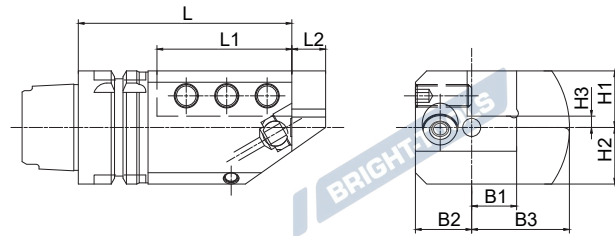

Size	L	L1	L2	B1	B2	B3	H1	H2	H3	G
HSK50T-SBV2020R-105	105	60	15	20	25	43.5	25	25	5	M10
HSK50T-SBV2020L-105	105	60	15	20	25	43.5	25	25	5	M10
HSK63T-SBV2020R-105	105	60	15	20	32	43.5	33	32	13	M10
HSK63T-SBV2020L-105	105	60	15	20	32	43.5	33	32	13	M10
HSK63T-SBV2525R-115	115	70	20	25	32	45	30	30	5	M12
HSK63T-SBV2525L-115	115	70	20	25	32	45	30	30	5	M12
HSK100T-SBV2525R-160	160	110	20	25	37	59	48	44	23	M12
HSK100T-SBV2525L-160	160	110	20	25	37	59	48	44	23	M12
HSK100T-SBV3232R-160	160	110	20	32	40	68.5	45	44	15	M14
HSK100T-SBV3232L-160	160	110	20	32	40	68.5	45	44	15	M14

HSK·T Turning Tools for External and Facing 复合车刀座, 外径端面加工

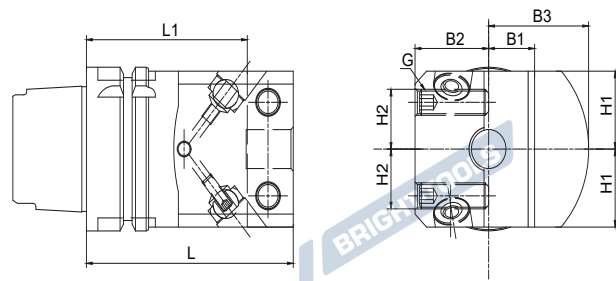

Size	L	L1	B1	B2	B3	H1	H2	G
HSK50T-SBH2020N-100	100	80	20	25	43.5	27.5	-	M10
HSK50T-SBH2020N-130	130	110	20	25	43.5	27.5	-	M10
HSK63T-SBH2020N-100	100	80	20	32	43.5	30	-	M10
HSK63T-SBH2525N-90	90	75	25	32	53	40.5	29.5	M12
HSK63T-SBH2525N-120	120	105	25	32	53	40.5	29.5	M12
HSK100T-SBH2525N-115	115	90	25	32	59	48	37	M12
HSK100T-SBH2525N-160	160	135	25	32	59	48	37	M12
HSK100T-SBH3232N-115	115	85	32	40	68.5	57	43	M14

HSK·T Turning Tools for External and Cut-off

复合车刀座, 外径切断加工

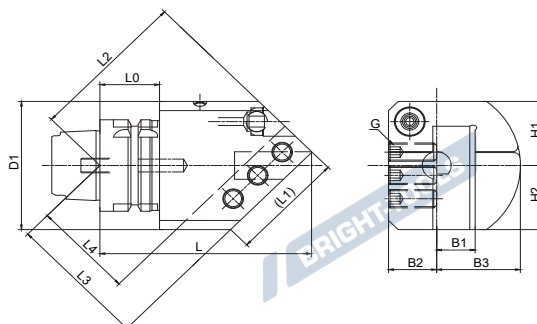

Size	L	L1	L2	L3	L4	D1	B1	B2	B3	H1	H2	G
HSK50T-SBN2020R-120	120	60	83.1	72.8	52.8	-	20	25	43.5	35	35	M10
HSK50T-SBN2020L-120	120	60	83.1	72.8	52.8	-	20	25	43.5	35	35	M10
HSK63T-SBN2020R-120	120	60	83.1	72.8	52.8	-	20	32	43.5	35	35	M10
HSK63T-SBN2020L-120	120	60	83.1	72.8	52.8	-	20	32	43.5	35	35	M10
HSK63T-SBN2525R-120	120	70	85.2	70.8	45.8	90	25	32	53	39	39	M12
HSK63T-SBN2525L-120	120	70	85.2	70.8	45.8	90	25	32	53	39	39	M12
HSK100T-SBN2525R-145	145	70	102.9	88.5	63.5	-	25	32	59	43	43	M12
HSK100T-SBN2525L-145	145	70	102.9	88.5	63.5	-	25	32	59	43	43	M12
HSK100T-SBN3232R-150	150	85	109.9	89	59	-	32	37	68.5	48	43	M14
HSK100T-SBN3232L-150	150	85	109.9	89	59	-	32	37	68.5	48	43	M14

HSK·T Turning Tools for External and Facing

复合车刀座, 外径端面加工

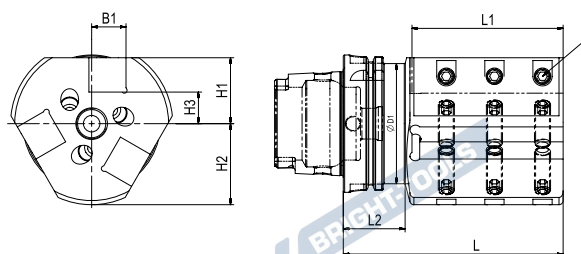

Size	L	L1	L2	D1	B1	H1	H2	H3	G
HSK50T-SBT2020R-105	105	60	42	41.5	20	35	43.5	15	M10
HSK50T-SBT2020L-105	105	60	42	41.5	20	35	43.5	15	M10
HSK63T-SBT2020R-105	105	60	42	52.5	20	35	43.5	15	M10
HSK63T-SBT2020L-105	105	60	42	52.5	20	35	43.5	15	M10
HSK63T-SBT2525R-125	125	70	42	52.5	25	43	53	18	M12
HSK63T-SBT2525L-125	125	70	42	52.5	25	43	53	18	M12
HSK100T-SBT2525R-160	160	110	45	87.5	25	48	59	23	M12
HSK100T-SBT2525L-160	160	110	45	87.5	25	48	59	23	M12

DCLNR | DCLNL 95°/80°

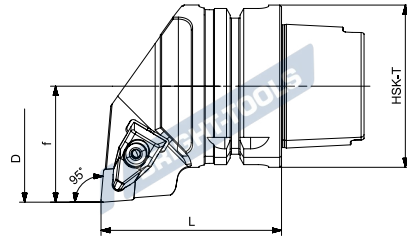
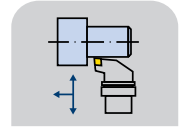

Size	f	D min	L	Direction	Inserts N.
HSK63T-DCLNR-45070-12	45	80	70	R	CN..1204..
HSK63T-DCLNL-45070-12	45	80	70	L	CN..1204..
HSK63T-DCLNR-45070-16	45	80	70	R	CN..1606..
HSK63T-DCLNL-45070-16	45	80	70	L	CN..1606..
HSK100T-DCLNR-63100-12	63	120	100	R	CN..1204..
HSK100T-DCLNL-63100-12	63	120	100	L	CN..1204..
HSK100T-DCLNR-63100-16	63	120	100	R	CN..1606..
HSK100T-DCLNL-63100-16	63	120	100	L	CN..1606..

HSK

PCLNR | PCLNL 95°/80°

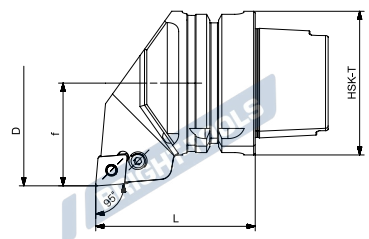
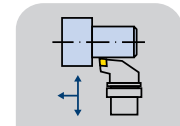
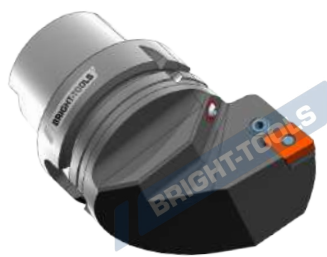

Size	f	D min	L	Direction	Inserts N.
HSK63T-PCLNR-45070-12	45	80	70	R	CN..1204..
HSK63T-PCLNL-45070-12	45	80	70	L	CN..1204..
HSK63T-PCLNR-45070-16	45	80	70	R	CN..1606..
HSK63T-PCLNL-45070-16	45	80	70	L	CN..1606..
HSK100T-PCLNR-63100-12	63	120	100	R	CN..1204..
HSK100T-PCLNL-63100-12	63	120	100	L	CN..1204..
HSK100T-PCLNR-63100-16	63	120	100	R	CN..1606..
HSK100T-PCLNL-63100-16	63	120	100	L	CN..1606..
HSK100T-PCLNR-63100-19	63	120	100	R	CN..1906..
HSK100T-PCLNL-63100-19	63	120	100	L	CN..1906..

DCMNN 50°/80°/50°

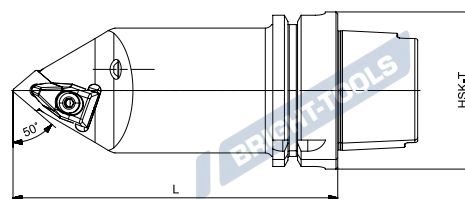
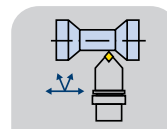

Size	L	Direction	Inserts N.
HSK63T-DCMNN-100-12	100	N	CN..1204..
HSK63T-DCMNN-130-12	130	N	CN..1204..
HSK63T-DCMNN-100-16	100	N	CN..1606..
HSK63T-DCMNN-130-16	130	N	CN..1606..
HSK100T-DCMNN-125-12	125	N	CN..1204..
HSK100T-DCMNN-125-16	125	N	CN..1606..

HSK

PCMNN 50°/80°/50°

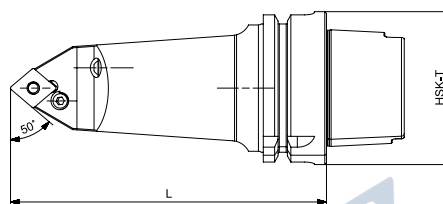
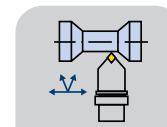

Size	L	Direction	Inserts N.
HSK63T-PCMNN-100-12	100	N	CN..1204..
HSK63T-PCMNN-130-12	130	N	CN..1204..
HSK63T-PCMNN-100-16	100	N	CN..1606..
HSK63T-PCMNN-130-16	130	N	CN..1606..
HSK100T-PCMNN-125-12	125	N	CN..1204..
HSK100T-PCMNN-125-16	125	N	CN..1606..

DDJNR | DDJNL 55°/93°

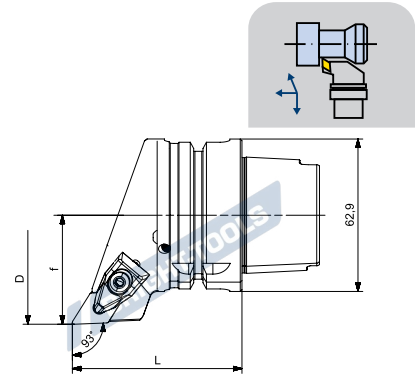

Size	f	L	Direction	Inserts N.
HSK63T-DDJNR-45075-15	45	75	R	DN..1506..
HSK63T-DDJNL-45075-15	45	75	L	DN..1506..
HSK100T-DDJNR-63100-15	63	100	R	DN..1506..
HSK100T-DDJNL-63100-15	63	100	L	DN..1506..

HSK

PDJNR | PDJNL 55°/93°

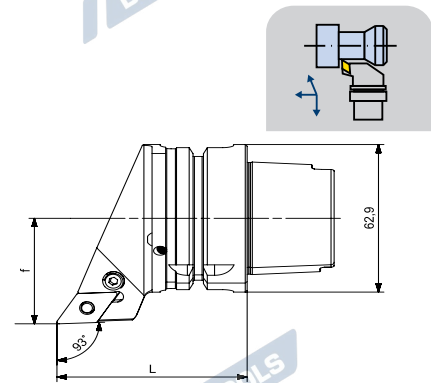

Size	f	L	Direction	Inserts N.
HSK63T-PDJNR-45070-15	45	70	R	DN..1506..
HSK63T-PDJNL-45070-15	45	70	L	DN..1506..
HSK100T-PDJNR-63100-15	63	100	R	DN..1506..
HSK100T-PDJNL-63100-15	63	100	L	DN..1506..

DDNNN 62.5°/55°/62.5°

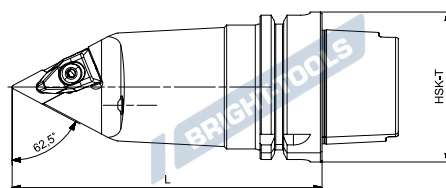
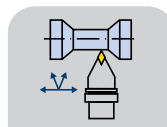

Size	L	Direction	Inserts N.
HSK63T-DDNNN-100-15	100	N	DN..1506..
HSK63T-DDNNN-130-15	130	N	DN..1506..
HSK100T-DDNNN-125-15	125	N	DN..1506..

HSK

PDNNN 62.5°/55°/62.5°

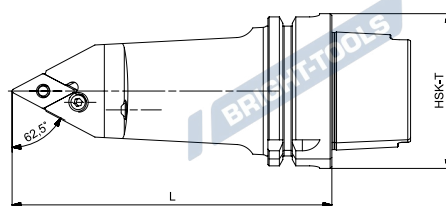
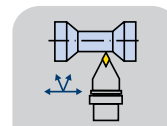

Size	L	Direction	Inserts N.
HSK63T-PDNNN-100-15	100	N	DN..1506..
HSK63T-PDNNN-130-15	130	N	DN..1506..
HSK100T-PDNNN-125-15	125	N	DN..1506..

DDUNR | DDUNL 93°/55°

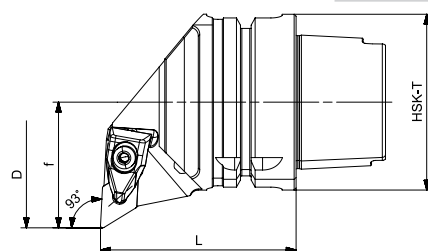
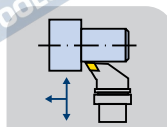

Size	f	D min	L	Direction	Inserts N.
HSK63T-DDUNR-45070-15	45	80	70	R	DN..1506..
HSK63T-DDUNL-45070-15	45	80	70	L	DN..1506..
HSK100T-DDUNR-63100-15	63	120	100	R	DN..1506..
HSK100T-DDUNL-63100-15	63	120	100	L	DN..1506..

PDUNR | PDUNL 93°/55°

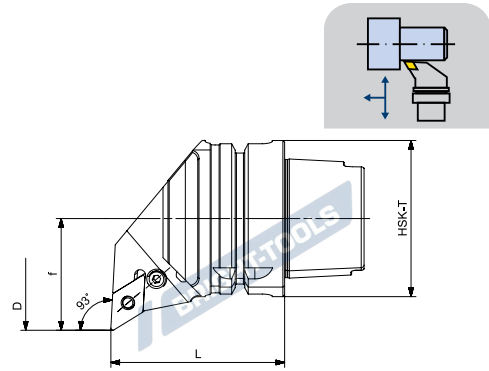

Size	f	D min	L	Direction	Inserts N.
HSK63T-PDUNR-45070-15	45	80	70	R	DN..1506..
HSK63T-PDUNL-45070-15	45	80	70	L	DN..1506..
HSK100T-PDUNR-63100-15	63	120	100	R	DN..1506..
HSK100T-PDUNL-63100-15	63	120	100	L	DN..1506..

DSBNR | DSBNL 90°/75°

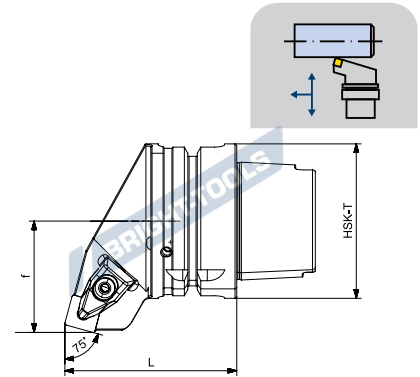

Size	f	L	Direction	Inserts N.
HSK63T-DSBNR-45070-12	45	70	R	SN..1204..
HSK63T-DSBNL-45070-12	45	70	L	SN..1204..
HSK100T-DSBNR-63100-12	63	100	R	SN..1204..
HSK100T-DSBNL-63100-12	63	100	L	SN..1204..

PSBNR | PSBNL 90°/75°

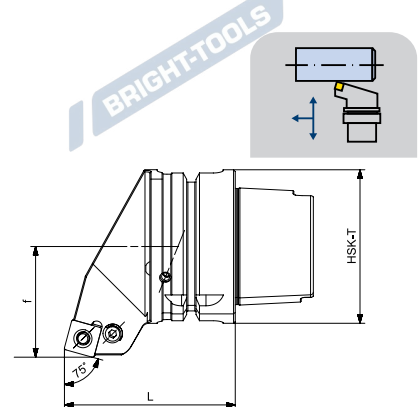

Size	f	L	Direction	Inserts N.
HSK63T-PSBNR-45070-12	45	70	R	SN..1204..
HSK63T-PSBNL-45070-12	45	70	L	SN..1204..
HSK100T-PSBNR-63100-12	63	100	R	SN..1204..
HSK100T-PSBNL-63100-12	63	100	L	SN..1204..

HSK

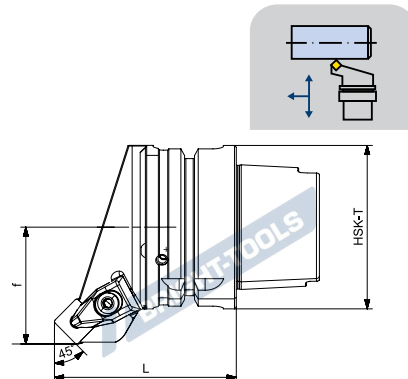
DSSNR | DSSNL 45°/90°

Size	f	D min	L	Direction	Inserts N.
HSK63T-DSSNR-45070-12	45	-	70	R	SN..1204..
HSK63T-DSSNL-45070-12	45	-	70	L	SN..1204..
HSK100T-DSSNR-63100-12	63	-	100	R	SN..1204..
HSK100T-DSSNL-63100-12	63	-	100	L	SN..1204..

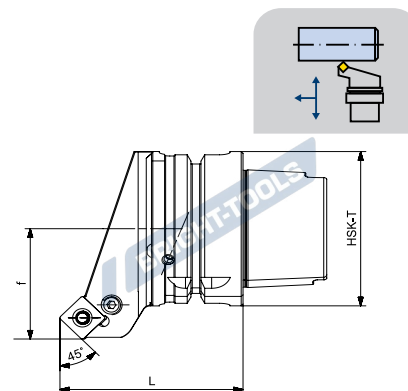
HSK
PSSNR | PSSNL 45°/90°

Size	f	L	Direction	Inserts N.
HSK63T-PSSNR-45070-12	45	70	R	SN..1204..
HSK63T-PSSNL-45070-12	45	70	L	SN..1204..
HSK100T-PSSNR-63100-12	63	100	R	SN..1204..
HSK100T-PSSNL-63100-12	63	100	L	SN..1204..

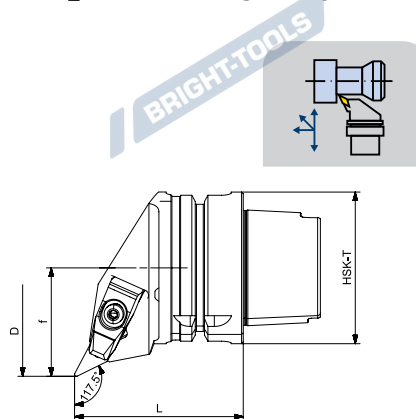
DVPCR | DVPNL 117.5°/35°

Size	f	D min	L	Direction	Inserts N.
HSK63T-DVPCR-45070-16	45	80	70	R	VN..1604..
HSK63T-DVPNL-45070-16	45	80	70	L	VN..1604..
HSK100T-DVPCR-63100-16	63	120	100	R	VN..1604..
HSK100T-DVPNL-63100-16	63	120	100	L	VN..1604..

DVUNR | DVUNL 93°/35°

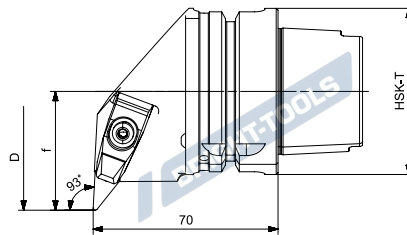
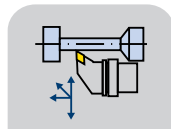

Size	f	D min	L	Direction	Inserts N.
HSK63T-DVUNR-45070-16	45	80	70	R	VN..1604..
HSK63T-DVUNL-45070-16	45	80	70	L	VN..1604..
HSK100T-DVUNR-63100-16	63	120	100	R	VN..1604..
HSK100T-DVUNL-63100-16	63	120	100	L	VN..1604..

DVVNN 72.5°/35°/72.5°

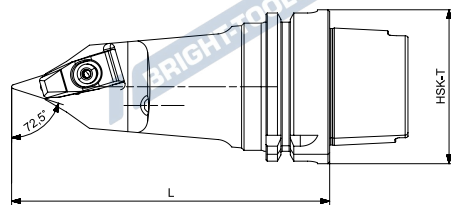
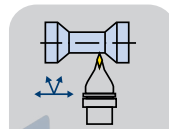

Size	L	Direction	Inserts N.
HSK63T-DVVNN-100-16	100	N	VN..1604..
HSK63T-DVVNN-130-16	130	N	VN..1604..
HSK100T-DVVNN-125-16	125	N	VN..1604..

DVJNR | DVJNL 93°/35°

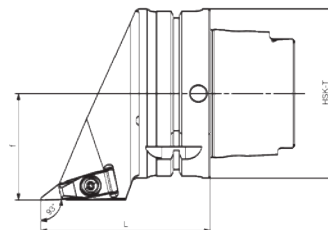
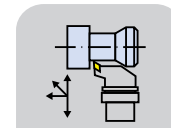

Size	f	D min	L	Direction	Inserts N.
HSK100T-DVJNR-63100-16	63	-	100	R	VN..1604..
HSK100T-DVJNL-63100-16	63	-	100	L	VN..1604..

HSK

DWLNR | DWLNL 95°/80°

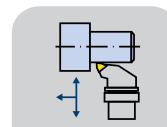
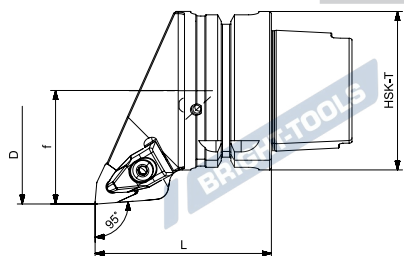

Size	f	D min	L	Direction	Inserts N.
HSK63T-DWLNR-45070-8	45	80	70	R	WN..0804..
HSK63T-DWLNL-45070-8	45	80	70	L	WN..0804..
HSK100T-DWLNR-63100-8	63	120	100	R	WN..0804..
HSK100T-DWLNL-63100-8	63	120	100	L	WN..0804..

HSK

PWLNR | PWLNL 95°/80°

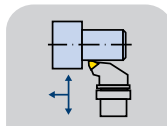
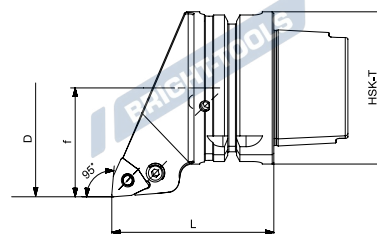

Size	f	D min	L	Direction	Inserts N.
HSK63T-PWLNR-45070-8	45	80	70	R	WN..0804..
HSK63T-PWLNL-45070-8	45	80	70	L	WN..0804..
HSK100T-PWLNR-63100-8	63	120	100	R	WN..0804..
HSK100T-PWLNL-63100-8	63	120	100	L	WN..0804..

SCLCR | SCLCL 95°/80°

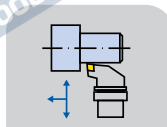
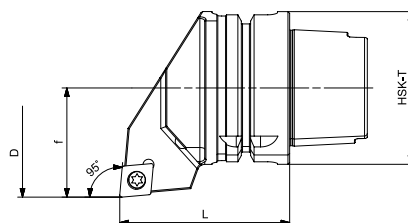

Size	f	D min	L	Direction	Inserts N.
HSK63T-SCLCR-45070-12	45	80	70	R	CC..1204..
HSK63T-SCLCL-45070-12	45	80	70	L	CC..1204..
HSK100T-SCLCR-63100-12	63	120	100	R	CC..1204..
HSK100T-SCLCL-63100-12	63	120	100	L	CC..1204..

SCMCN 50°/80°/50°

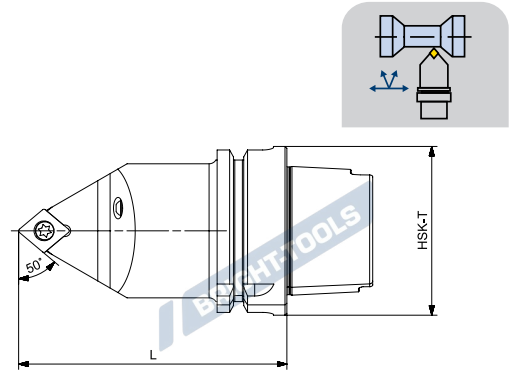

Size	L	Direction	Inserts N.
HSK63T-SCMCN-100-12	100	N	CC..1204..
HSK63T-SCMCN-130-12	130	N	CC..1204..
HSK100T-SCMCN-125-12	125	N	CC..1204..

SDQCR | SDQCL 107.5°/55°

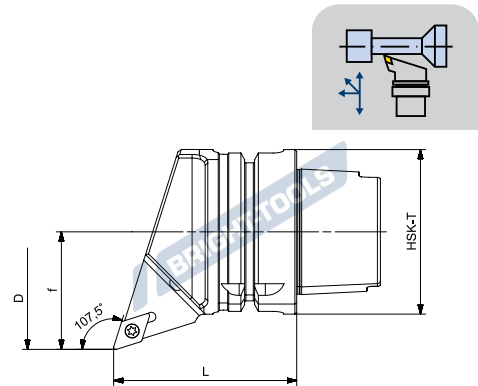

Size	f	D min	L	Direction	Inserts N.
HSK63T-SDQCR-45070-11	45	80	70	R	DC..11T3..
HSK63T-SDQCL-45070-11	45	80	70	L	DC..11T3..
HSK100T-SDQCR-63100-11	63	120	100	R	DC..11T3..
HSK100T-SDQCL-63100-11	63	120	100	L	DC..11T3..

SDNCN 62.5°/55°/62.5°

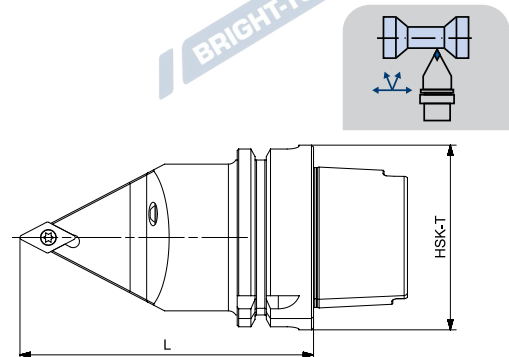

Size	L	Direction	Inserts N.
HSK63T-SDNCN-100-11	100	N	DC..11T3..
HSK63T-SDNCN-130-11	130	N	DC..11T3..
HSK100T-SDNCN-125-11	125	N	DC..11T3..

HSK

SDJCR | SDJCL 93°/55°

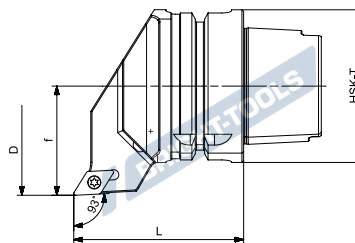
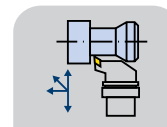

Size	f	D min	L	Direction	Inserts N.
HSK63T-SDJCR-45070-11	45	80	70	R	DC..11T3..
HSK63T-SDJCL-45070-11	45	80	70	L	DC..11T3..
HSK100T-SDJCR-63100-11	63	120	100	R	DC..11T3..
HSK100T-SDJCL-63100-11	63	120	100	L	DC..11T3..

HSK

SDUCR | SDUCL 93°/55°

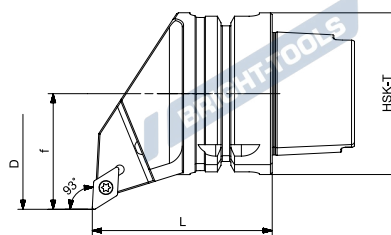
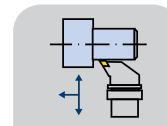

Size	f	D	L	Direction	Inserts N.
HSK63T-SDUCR-45070-11	45	80	70	R	DC..11T3..
HSK63T-SDUCL-45070-11	45	80	70	L	DC..11T3..
HSK100T-SDUCR-63100-11	63	120	100	R	DC..11T3..
HSK100T-SDUCL-63100-11	63	120	100	L	DC..11T3..

SSBCR | SSBCL 75°/90°

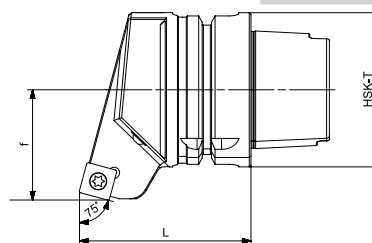
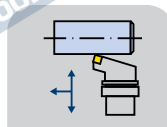

Size	f	L	Direction	Inserts N.
HSK63T-SSBCR-45070-12	45	70	R	SC..1204..
HSK63T-SSBCL-45070-12	45	70	L	SC..1204..
HSK100T-SSBCR-63100-12	63	100	R	SC..1204..
HSK100T-SSBCL-63100-12	63	100	L	SC..1204..

SSSCR | SSSCL 45°/90°

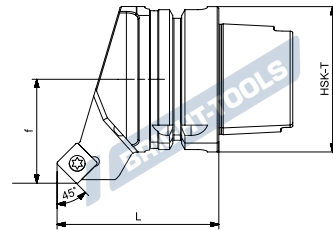
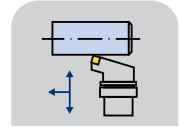

Size	f	L	Direction	Inserts N.
HSK63T-SSSCR-45070-12	45	70	R	SC..1204..
HSK63T-SSSCL-45070-12	45	70	L	SC..1204..
HSK100T-SSSCR-63100-12	63	100	R	SC..1204..
HSK100T-SSSCL-63100-12	63	100	L	SC..1204..

SVPBR | SVPBL | SVPCR | SVPCL 117.5°/35°

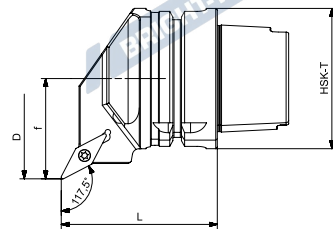
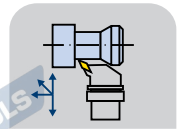

Size	f	D min	L	Direction	Inserts N.
HSK63T-SVPBR-45070-16	45	80	70	R	VB..1604..
HSK63T-SVPBL-45070-16	45	80	70	L	VB..1604..
HSK63T-SVPCR-45070-16	45	80	70	R	VC..1604..
HSK63T-SVPCL-45070-16	45	80	70	L	VC..1604..
HSK100T-SVPBR-63100-16	63	120	100	R	VB..1604..
HSK100T-SVPBL-63100-16	63	120	100	L	VB..1604..
HSK100T-SVPCR-63100-16	63	120	100	R	VC..1604..
HSK100T-SVPCL-63100-16	63	120	100	L	VC..1604..

HSK

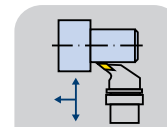
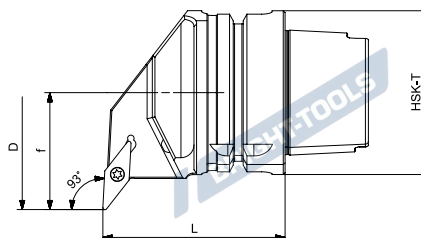

SVUBR | SVUBL | SVUCR | SVUCL 93°/35°

Size	f	D min	L	Direction	Inserts N.
HSK63T-SVUBR-45070-16	45	80	70	R	VB..1604..
HSK63T-SVUBL-45070-16	45	80	70	L	VB..1604..
HSK63T-SVUCR-45070-16	45	80	70	R	VC..1604..
HSK63T-SVUCL-45070-16	45	80	70	L	VC..1604..
HSK100T-SVUBR-63100-16	63	120	100	R	VB..1604..
HSK100T-SVUBL-63100-16	63	120	100	L	VB..1604..
HSK100T-SVUCR-63100-16	63	120	100	R	VC..1604..
HSK100T-SVUCL-63100-16	63	120	100	L	VC..1604..

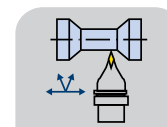
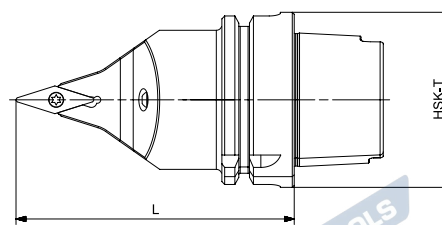
HSK
SVVBN | SVVCN 72.5°/35°/72.5°

Size	L	Direction	Inserts N.
HSK63T-SVVBN-100-16	100	N	VB..1604..
HSK63T-SVVBN-130-16	130	N	VB..1604..
HSK63T-SVVCN-100-16	100	N	VC..1604..
HSK63T-SVVCN-130-16	130	N	VC..1604..
HSK100T-SVVBN-125-16	125	N	VB..1604..
HSK100T-SVVCN-125-16	125	N	VC..1604..

SVJBR | SVJBL | SVJCR | SVJCL 93°/35°

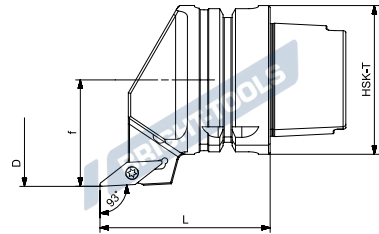
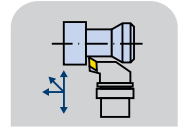

Size	f	D min	L	Direction	Inserts N.
HSK63T-SVJBR-45072-16	45	80	71.5	R	VB..1604..
HSK63T-SVJBL-45072-16	45	80	71.5	L	VB..1604..
HSK63T-SVJCR-45072-16	45	80	71.5	R	VC..1604..
HSK63T-SVJCL-45072-16	45	80	71.5	L	VC..1604..
HSK100T-SVJBR-63100-16	63	120	100	R	VB..1604..
HSK100T-SVJBL-63100-16	63	120	100	L	VB..1604..
HSK100T-SVJCR-63100-16	63	120	100	R	VC..1604..
HSK100T-SVJCL-63100-16	63	120	100	L	VC..1604..

HSK

DCLNR | DCLNL 95°/80°

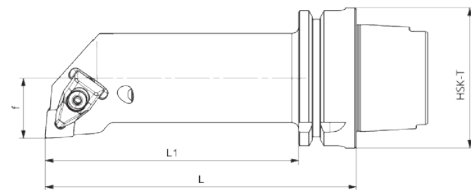
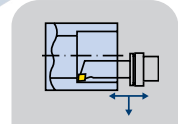

Size	f	D min	L	L1	Direction	Inserts N.
HSK63T-DCLNR-27140-12	27	50	140	114	R	CN..1204..
HSK63T-DCLNL-27140-12	27	50	140	114	L	CN..1204..
HSK63T-DCLNR-27180-12	27	50	180	154	R	CN..1204..
HSK63T-DCLNL-27180-12	27	50	180	154	L	CN..1204..
HSK100T-DCLNR-27150-12	27	50	150	121	R	CN..1204..
HSK100T-DCLNL-27150-12	27	50	150	121	L	CN..1204..
HSK100T-DCLNR-27200-12	27	50	200	171	R	CN..1204..
HSK100T-DCLNL-27200-12	27	50	200	171	L	CN..1204..
HSK100T-DCLNR-35150-12	35	63	150	121	R	CN..1204..
HSK100T-DCLNL-35150-12	35	63	150	121	L	CN..1204..
HSK100T-DCLNR-35200-12	35	63	200	171	R	CN..1204..
HSK100T-DCLNL-35200-12	35	63	200	171	L	CN..1204..

长型 PCLNR | PCLNL 95°/80°

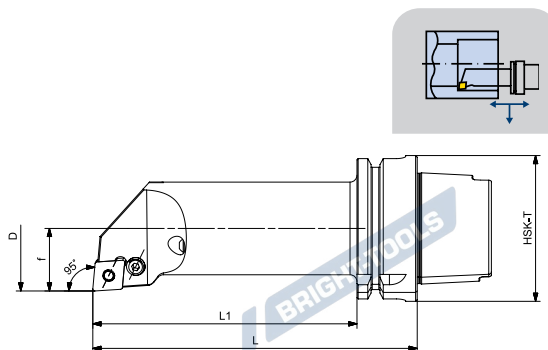

Size	f	D min	L	L1	Direction	Inserts N.
HSK63T-PCLNR-27140-12	27	50	140	114	R	CN..1204..
HSK63T-PCLNL-27140-12	27	50	140	114	L	CN..1204..
HSK63T-PCLNR-27180-12	27	50	180	154	R	CN..1204..
HSK63T-PCLNL-27180-12	27	50	180	154	L	CN..1204..
HSK100T-PCLNR-27150-12	27	50	150	121	R	CN..1204..
HSK100T-PCLNL-27150-12	27	50	150	121	L	CN..1204..
HSK100T-PCLNR-27200-12	27	50	200	171	R	CN..1204..
HSK100T-PCLNL-27200-12	27	50	200	171	L	CN..1204..
HSK100T-PCLNR-35150-12	35	63	150	121	R	CN..1204..
HSK100T-PCLNL-35150-12	35	63	150	121	L	CN..1204..
HSK100T-PCLNR-35200-12	35	63	200	171	R	CN..1204..
HSK100T-PCLNL-35200-12	35	63	200	171	L	CN..1204..

HSK

长型 PDQNR | PDQNL 107.5°/55°

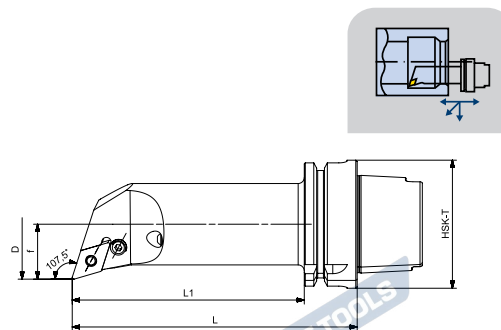

Size	f	D min	L	L1	Direction	Inserts N.
HSK63T-PDQNR-27140-15	27	50	140	114	R	DN..1506..
HSK63T-PDQNL-27140-15	27	50	140	114	L	DN..1506..
HSK63T-PDQNR-27180-15	27	50	180	154	R	DN..1506..
HSK63T-PDQNL-27180-15	27	50	180	154	L	DN..1506..
HSK100T-PDQNR-27150-15	27	50	150	121	R	DN..1506..
HSK100T-PDQNL-27150-15	27	50	150	121	L	DN..1506..
HSK100T-PDQNR-27200-15	27	50	200	171	R	DN..1506..
HSK100T-PDQNL-27200-15	27	50	200	171	L	DN..1506..
HSK100T-PDQNR-35150-15	35	63	150	121	R	DN..1506..
HSK100T-PDQNL-35150-15	35	63	150	121	L	DN..1506..
HSK100T-PDQNR-35200-15	35	63	200	171	R	DN..1506..
HSK100T-PDQNL-35200-15	35	63	200	171	L	DN..1506..

长型 DDQNR | DDQNL 107.5°/55°

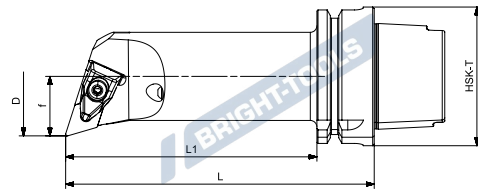
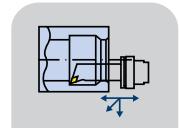

Size	f	D min	L	L1	Direction	Inserts N.
HSK63T-DDQNR-27140-15	27	50	140	114	R	DN..1506..
HSK63T-DDQNL-27140-15	27	50	140	114	L	DN..1506..
HSK63T-DDQNR-27180-15	27	50	180	154	R	DN..1506..
HSK63T-DDQNL-27180-15	27	50	180	154	L	DN..1506..
HSK100T-DDQNR-27150-15	27	50	150	121	R	DN..1506..
HSK100T-DDQNL-27150-15	27	50	150	121	L	DN..1506..
HSK100T-DDQNR-27200-15	27	50	200	171	R	DN..1506..
HSK100T-DDQNL-27200-15	27	50	200	171	L	DN..1506..
HSK100T-DDQNR-35150-15	35	63	150	121	R	DN..1506..
HSK100T-DDQNL-35150-15	35	63	150	121	L	DN..1506..
HSK100T-DDQNR-35200-15	35	63	200	171	R	DN..1506..
HSK100T-DDQNL-35200-15	35	63	200	171	L	DN..1506..

HSK

长型 SCLCR | SCLCL 95°/80°

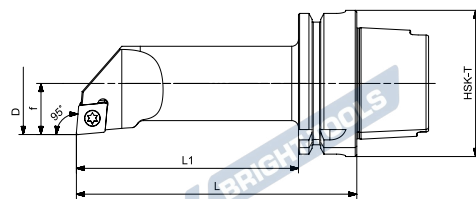
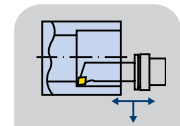

Size	f	D min	L	L1	Direction	Inserts N.
HSK63T-SCLCR-22125-12	22	40	125	99	R	CC..1204..
HSK63T-SCLCL-22125-12	22	40	125	99	L	CC..1204..
HSK63T-SCLCR-22160-12	22	40	160	134	R	CC..1204..
HSK63T-SCLCL-22160-12	22	40	160	134	L	CC..1204..
HSK63T-SCLCR-27140-12	27	50	140	114	R	CC..1204..
HSK63T-SCLCL-27140-12	27	50	140	114	L	CC..1204..
HSK63T-SCLCR-27180-12	27	50	180	154	R	CC..1204..
HSK63T-SCLCL-27180-12	27	50	180	154	L	CC..1204..

长型 SVQBR | SVQBL 107.5°/55°

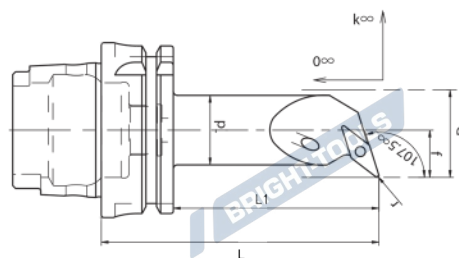

Size	d	L	L1	f	k°	D	r	Inserts N.
HSK63T-SVQBR-13085-11	20	85	59	13	-8	25	0.4	VB..1102..
HSK63T-SVQBL-13085-11	20	85	59	13	-8	25	0.4	VB..1102..
HSK63T-SVQBR-17100-11	25	100	74	17	-5	32	0.4	VB..1102..
HSK63T-SVQBL-17100-11	25	100	74	17	-5	32	0.4	VB..1102..
HSK63T-SVQBR22120-16	32	120	94	22	-10	40	0.8	VB..1604..
HSK63T-SVQBL22120-16	32	120	94	22	-10	40	0.8	VB..1604..
HSK63T-SVQBR-27140-16	40	140	114	27	-10	50	0.8	VB..1604..
HSK63T-SVQBL-27140-16	40	140	114	27	-10	50	0.8	VB..1604..

HSK

长型 SVQCR | SVQCL 107.5°/55°

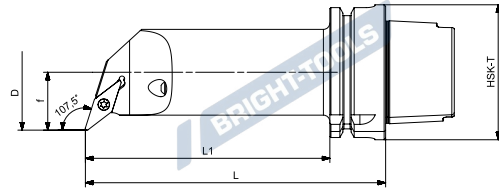
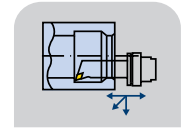

Size	f	D min	L	L1	Direction	Inserts N.
HSK63T-SVQCR-22125-16	22	40	125	99	R	VC..1604
HSK63T-SVQCL-22125-16	22	40	125	99	L	VC..1604
HSK63T-SVQCR-22160-16	22	40	160	134	R	VC..1604
HSK63T-SVQCL-22160-16	22	40	160	134	L	VC..1604
HSK63T-SVQCR-27140-16	27	50	140	114	R	VC..1604
HSK63T-SVQCL-27140-16	27	50	140	114	L	VC..1604
HSK63T-SVQCR-27180-16	27	50	180	154	R	VC..1604
HSK63T-SVQCL-27180-16	27	50	180	154	L	VC..1604

HSK