

BRIGHT-TOOLS

BRIGHT-TOOLS

# TOOL HOLDERS

# HYDRAULIC

BRIGHT-TOOLS

BRIGHT-TOOLS

BRIGHT-TOOLS

BRIGHT-TOOLS

BRIGHT-TOOLS

BRIGHT-TOOLS

## Hydraulic Chuck Construction

## 液压刀柄构造图

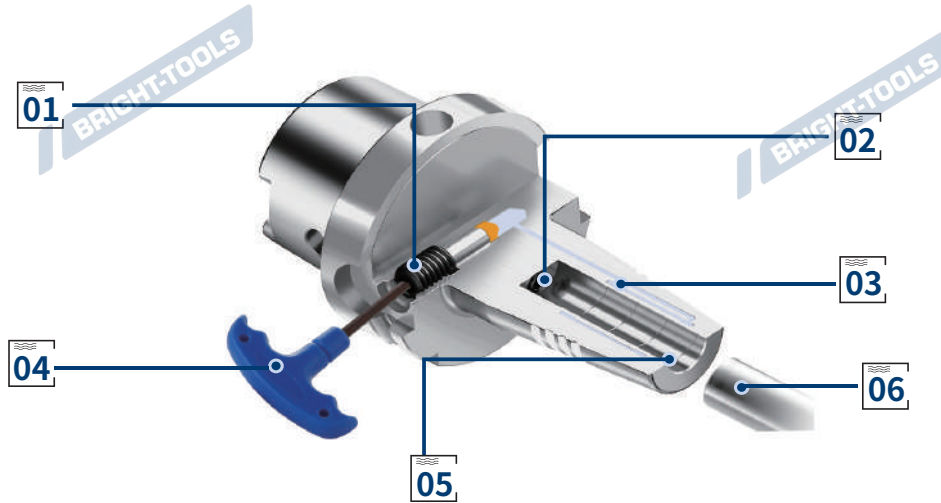

### 01 Lock Screw

Tighten to locking screw to a dead stop.

### 01 锁紧螺钉

通过锁紧螺钉将液压油压缩到油腔中

### 02 Adjust Screw

To preset cutting tools.

### 02 定位螺钉

用于调节刀具

### 03 Expansion Sleeve and Chamber System

The chamber system fills with hydraulic fluid, exerting a damping effect on the clamped tool.

### 03 膨胀套和油腔

通过对油腔内液压油施加压力，从而膨胀夹紧刀具

### 04 Hex Key

To tighten locking screw for fast cutting tool change.

### 04 内六角扳手

用于锁紧螺钉，实现快速换刀

### 05 The Grooves

The large clamping pressure creates a displacement of oil, grease, or lubricant residues into the groove, so bore surfaces remains dry.

### 05 污垢槽

液压刀柄的巨大夹紧压力会导致油、油脂或润滑剂残留物进入凹槽，从而使表面保持干燥。

### 06 Cutting Tool

The cutting tool is clamped with high run-out.

### 06 刀具

直接夹持圆柱形刀具



**High Precision**

The hydraulic chuck is with high precision, which greatly improves the dimensional accuracy, effectively prevents the tool from breaking, and reduces tool wear.

**精度高**

液压刀柄极高的夹持精度在钻孔和铰孔加工时大大提高孔的尺寸精度并有效防止断刀，在铣削加工中则使多刃刀具各切削刃能够均匀地切入工件，从而改善切削状态，降低刀具磨损。



**Large Clamping Force**

The special clamping method makes it evenly clamp the cutting tool 360 degrees, with large clamping force, good rigidity, and higher clamping torque.

**夹持力大**

液压刀柄特殊的夹持方式使之 360 度均匀夹紧刀具，夹持力大，刚性好，能够传递更高的夹持扭矩。

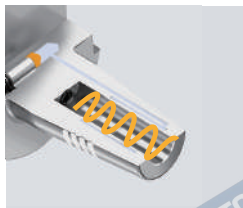

**Better Anti-Vibration Result**

The damping structure has excellent damping and shock absorption performance. It can reduce the vibration generated in the cutting process and improve the surface quality of the workpiece.

**减震效果好**

液压刀柄油腔内的油增加结构阻尼，从而改善刀柄夹持的动力学特性，使之具有优良的阻尼减震性能。可以降低切削加工中产生的振动，提高工件的表面质量。



**Easy to Install and Remove**

Easy to insert and remove the cutting tool by a hex wrench.

**装卸简单**

液压刀柄装卸刀具非常方便，只要使用一把六角扳手就可以轻松地装卸刀具，不需要任何辅助装置。



**Hydraulic Collet**

One tool holder can clamp different cutting tool diameters by collets.

**适合高速加工**

液压刀柄受空腔壁的限制，高速旋转时不产生离心力，适合高速加工。

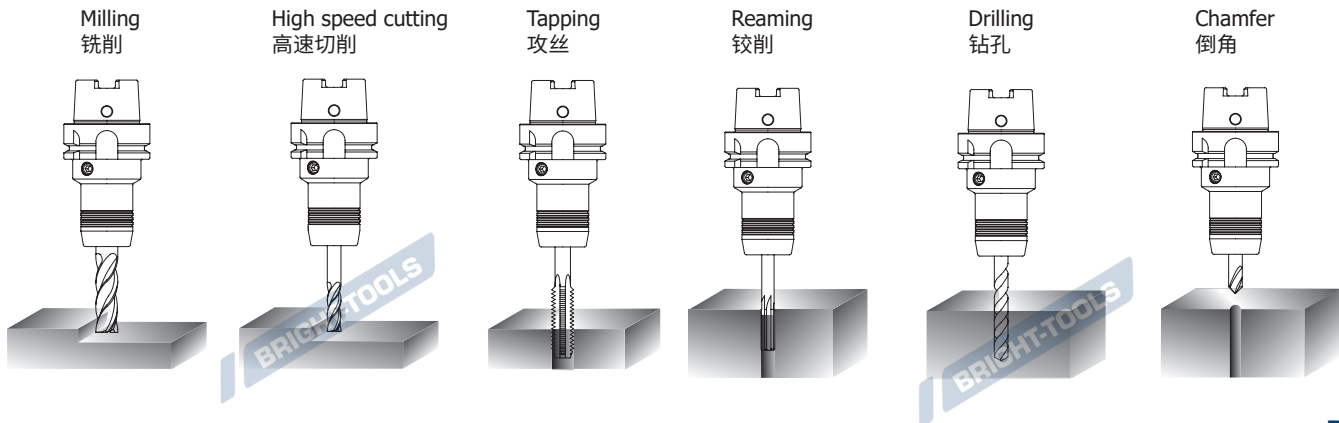

# HYDRAULIC TOOLING SYSTEM

## HYDRAULIC 工具系统

**HYDRO**

BT Hydraulic Chuck, Standard .....	B.06
BT 液压刀柄, 标准型	
BBT Hydraulic Chuck, Standard .....	B.09
BBT 液压刀柄, 标准型	
SK Hydraulic Chuck, Standard .....	B.10
SK 液压刀柄, 标准型	
CAT Hydraulic Chuck, Standard .....	B.12
CAT 液压刀柄, 标准型 .....	B.12
HSK Hydraulic Chuck, Standard .....	B.13
HSK 液压刀柄, 标准型	
BT Hydraulic Chuck, Short.....	B.17
BT 液压刀柄, 超短型	
SK Hydraulic Chuck, Short.....	B.17
SK 液压刀柄, 超短型	
BT Hydraulic Chuck, Power Design.....	B.18
BT 液压刀柄, 强力型	
SK Hydraulic Chuck, Power Design.....	B.18
SK 液压刀柄, 强力型	
HSK Hydraulic Chuck, Power Design.....	B.19
HSK 液压刀柄, 强力型	
BT Hydraulic Chuck, for Mould.....	B.20
BT 液压刀柄, 模具型	
SK Hydraulic Chuck, for Mould.....	B.21
SK 液压刀柄, 模具型	
HSK Hydraulic Chuck, for Mould.....	B.22
HSK 液压刀柄, 模具型	
BT Hydraulic Chuck, Slim.....	B.23
BT 液压刀柄, 细长型	
SK Hydraulic Chuck, Slim.....	B.24
SK 液压刀柄, 细长型	
CAT Hydraulic Chuck, Slim.....	B.26
CAT 液压刀柄, 细长型	
HSK Hydraulic Chuck, Slim.....	B.30
HSK 液压刀柄, 细长型	
Hydraulic Chuck, Slim.....	B.36
直柄液压刀柄, 细长型	
SK Hydraulic Chuck, for Grind.....	B.37
SK 液压刀柄, 研磨机专用	
MTB Hydraulic Chuck.....	B.37
莫氏液压刀柄	
Hydraulic Chuck For CNC automatic lathe.....	B.38
液压刀柄, 走心机专用	
Hydraulic Collet.....	B.39
液压止水筒夹	
Hydraulic Collet with Coolant Channels.....	B.41
液压筒夹, 端面出水型	
Hydraulic Collet Set .....	B.43
液压筒夹套装	
Hydraulic Chuck Set .....	B.44
液压刀柄套装	



## Hydraulic Chuck, Standard 液压刀柄, 标准型

**HYDRO**

A ↗ ≤0.003	RPM G2.5/25000	AD
---------------	-------------------	----

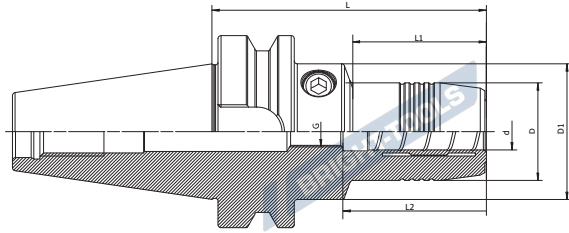

Size	d	D	D1	L	L1	L2	G
BT30-HY06-70	06	26	45	70	28	38	M5
BT30-HY08-70	08	28	45	70	28.5	38	M6
BT30-HY10-75	10	30	45	75	34	42	M8x1
BT30-HY12-85	12	32	45	85	44	47	M10x1
BT30-HY14-85	14	34	45	85	44.5	47	M10x1
BT30-HY16-90	16	38	45	90	50	50	M10x1
BT30-HY18-90	18	40	45	90	50.5	50	M10x1
BT30-HY20-90	20	42	45	90	51	52	M10x1
BT40-HY06-65	06	26	44.5	65	43	38	M5
BT40-HY08-65	08	28	44.5	65	44.5	38	M6
BT40-HY10-65	10	30	44.5	65	44.5	42	M8x1
BT40-HY12-65	12	32	44.5	65	44.5	47	M10x1
BT40-HY14-65	14	34	44.5	65	44.5	47	M10x1
BT40-HY16-65	16	38	50	65	44.5	50	M12x1
BT40-HY18-65	18	40	50	65	44.5	50	M8x1
BT40-HY20-65	20	42	50	65	45.5	52	M10x1
BT40-HY06-90	06	26	44.5	90	43	38	M5
BT40-HY08-90	08	28	44.5	90	43.5	38	M6
BT40-HY10-90	10	30	44.5	90	44	42	M8x1
BT40-HY12-90	12	32	44.5	90	44	47	M10x1
BT40-HY14-90	14	34	44.5	90	44.5	47	M10x1
BT40-HY16-90	16	38	50	90	44.5	50	M12x1
BT40-HY18-90	18	40	50	90	44.5	50	M12x1
BT40-HY20-90	20	42	50	90	45	52	M12x1
BT40-HY25-100	25	57	62	100	54	58	M16x1
BT40-HY32-105	32	64	-	105	-	62	M16x1

**Hydraulic Chuck, Standard**  
**液压刀柄, 标准型**



A ↗ ≤0.003	RPM G2.5/25000	AD
---------------	-------------------	----

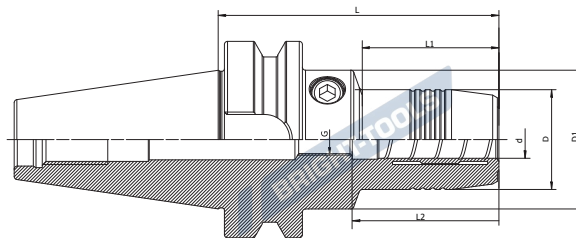

**HYDRO**

Size	d	D	D1	L	L1	L2	G
BT40-HY06-150	06	26	50	150	102	38	M5
BT40-HY08-150	08	28	50	150	102	38	M6
BT40-HY10-150	10	30	50	150	103	42	M8x1
BT40-HY12-150	12	32	50	150	103	47	M10x1
BT40-HY14-150	14	34	50	150	103.5	47	M10x1
BT40-HY16-150	16	38	50	150	104.5	50	M12x1
BT40-HY18-150	18	40	50	150	104.5	50	M12x1
BT40-HY20-150	20	42	50	150	105	52	M16x1
BT40-HY25-150	25	57	62	150	104	58	M16x1
BT40-HY32-150	32	64	-	150	-	62	M16x1
BT40-HY06-200	06	26	44.5	200	152.5	38	M5
BT40-HY08-200	08	28	44.5	200	154	38	M6
BT40-HY10-200	10	30	44.5	200	154	42	M8x1
BT40-HY12-200	12	32	44.5	200	155	47	M10x1
BT40-HY14-200	14	34	44.5	200	155	47	M10x1
BT40-HY16-200	16	38	50	200	156	50	M12x1
BT40-HY18-200	18	40	50	200	156	50	M10x1
BT40-HY20-200	20	42	50	200	155	52	M16x1
BT40-HY25-200	25	57	62	200	157	58	M16x1
BT40-HY32-200	32	64	-	200	-	62	M16x1
BT50-HY06-90	06	26	44.5	90	34	38	M5
BT50-HY08-90	08	28	44.5	90	34	38	M6
BT50-HY10-90	10	30	44.5	90	34	42	M8x1
BT50-HY12-90	12	32	44.5	90	34	47	M10x1
BT50-HY14-90	14	34	44.5	90	34	47	M10x1
BT50-HY16-90	16	38	50	90	34	50	M12x1
BT50-HY18-90	18	40	50	90	34	50	M12x1
BT50-HY20-90	20	42	50	90	34	52	M16x1
BT50-HY25-105	25	57	70	105	46	58	M16x1
BT50-HY32-115	32	64	70	115	57.5	62	M16x1

## Hydraulic Chuck, Standard

### 液压刀柄, 标准型

**HYDRO**

A ↗ ≤0.003	RPM G2.5/25000	AD
---------------	-------------------	----

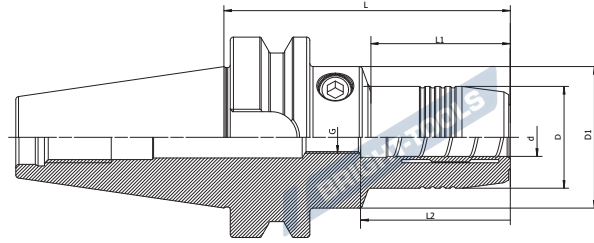

Size	d	D	D1	L	L1	L2	G
BT50-HY06-120	06	26	44.5	120	34	38	M5
BT50-HY08-120	08	28	44.5	120	34	38	M6
BT50-HY10-120	10	30	44.5	120	34	42	M8×1
BT50-HY12-120	12	32	44.5	120	34	47	M10×1
BT50-HY14-120	14	34	44.5	120	34	47	M10×1
BT50-HY16-120	16	38	50	120	34	50	M12×1
BT50-HY18-120	18	40	50	120	34	50	M12×1
BT50-HY20-120	20	42	50	120	34	52	M16×1
BT50-HY06-150	06	26	44.5	150	34	38	M5
BT50-HY08-150	08	28	44.5	150	34	38	M6
BT50-HY10-150	10	30	44.5	150	34	42	M8×1
BT50-HY12-150	12	32	44.5	150	34	47	M10×1
BT50-HY14-150	14	34	44.5	150	34	47	M10×1
BT50-HY16-150	16	38	50	150	34	50	M12×1
BT50-HY18-150	18	40	50	150	34	50	M12×1
BT50-HY20-150	20	42	50	150	34	52	M16×1
BT50-HY25-150	25	57	70	150	91	58	M16×1
BT50-HY32-150	32	64	70	150	93	62	M16×1

**Hydraulic Chuck, Standard**  
**液压刀柄, 标准型**



A ↗ ≤0.003	RPM G2.5/25000	AD
---------------	-------------------	----

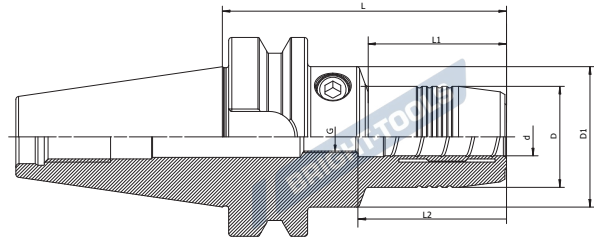

**HYDRO**

Size	d	D	D1	L	L1	L2	G
BBT40-HY06-90	06	26	44.5	90	43	38	M5
BBT40-HY08-90	08	28	44.5	90	43.5	38	M6
BBT40-HY10-90	10	30	44.5	90	44	42	M8x1
BBT40-HY12-90	12	32	44.5	90	44	47	M10x1
BBT40-HY14-90	14	34	44.5	90	44.5	47	M10x1
BBT40-HY16-90	16	38	50	90	44.5	50	M12x1
BBT40-HY18-90	18	40	50	90	44.5	50	M12x1
BBT40-HY20-90	20	42	50	90	45	52	M12x1
BBT40-HY25-100	25	57	62	100	54	58	M16x1
BBT40-HY32-105	32	64	-	105	-	62	M16x1
BBT50-HY06-90	06	26	44.5	90	34	38	M5
BBT50-HY08-90	08	28	44.5	90	34	38	M6
BBT50-HY10-90	10	30	44.5	90	34	42	M8x1
BBT50-HY12-90	12	32	44.5	90	34	47	M10x1
BBT50-HY14-90	14	34	44.5	90	34	47	M10x1
BBT50-HY16-90	16	38	50	90	34	50	M12x1
BBT50-HY18-90	18	40	50	90	34	50	M12x1
BBT50-HY20-90	20	42	50	90	34	52	M16x1
BBT50-HY25-105	25	57	70	105	48.5	58	M16x1
BBT50-HY32-115	32	64	70	115	59.5	62	M16x1
BBT50-HY06-120	06	26	44.5	120	34	38	M5
BBT50-HY08-120	08	28	44.5	120	34	38	M6x1
BBT50-HY10-120	10	30	44.5	120	34	42	M8x1
BBT50-HY12-120	12	32	44.5	120	34	47	M10x1
BBT50-HY14-120	14	34	44.5	120	34	47	M10x1
BBT50-HY16-120	16	38	44.5	120	34	50	M12x1
BBT50-HY18-120	18	40	44.5	120	34	50	M12x1
BBT50-HY20-120	20	42	50	120	34	52	M16x1

**BRIGHT-TOOLS**

**BRIGHT-TOOLS**

## Hydraulic Chuck, Standard

### 液压刀柄, 标准型

**HYDRO**

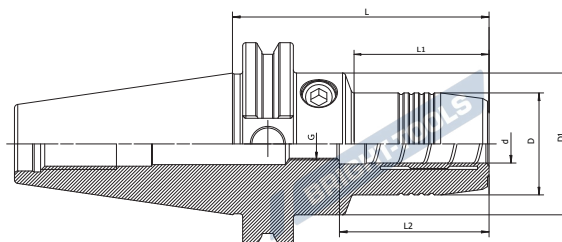

A ↗ ≤0.003	RPM G2.5/25000	AD/B
---------------	-------------------	------



Size	d	D	D1	L	L1	L2	G
SK30-HY06-70	06	26	45	70	20	38	M5
SK30-HY08-70	08	28	45	70	20	38	M6
SK30-HY10-75	10	30	45	75	21	42	M8x1
SK30-HY12-85	12	32	44.5	85	44	47	M10x1
SK30-HY14-85	14	34	45	85	22	47	M10x1
SK30-HY16-90	16	38	45	90	50	50	M6
SK30-HY18-90	18	40	45	90	50	50	M10x1
SK30-HY20-90	20	42	45	90	50	52	M6
SK40-HY06-65	06	26	44.5	65	42	38	M5
SK40-HY08-65	08	28	49.5	65	30	38	M6
SK40-HY10-65	10	30	49.5	65	31	42	M8x1
SK40-HY12-65	12	32	44.5	65	43	47	M10x1
SK40-HY16-65	16	38	49.5	65	33	50	M12x1
SK40-HY20-65	20	42	49	65	44	52	M10x1
SK40-HY06-80.5	06	26	44.5	80.5	41.5	38	M5
SK40-HY08-80.5	08	28	44.5	80.5	42	38	M6
SK40-HY10-80.5	10	30	44.5	80.5	42	42	M8x1
SK40-HY12-80.5	12	32	44.5	80.5	42.5	47	M10x1
SK40-HY14-80.5	14	34	44.5	80.5	43	47	M10x1
SK40-HY16-80.5	16	38	50	80.5	43	50	M12x1
SK40-HY20-80.5	20	42	49	80.5	44	52	M12x1
SK40-HY25-80.5	25	57	68	80.5	26	58	M16x1
SK40-HY32-80.5	32	64	80	80.5	23	62	M16x1
SK40-HY06-110	06	26	44.5	110	71.5	38	M5
SK40-HY08-110	08	28	44.5	110	71.5	38	M6
SK40-HY10-110	10	30	44.5	110	72	42	M8x1
SK40-HY12-110	12	32	44.5	110	72.5	47	M10x1
SK40-HY16-110	16	38	50	110	72	50	M12x1
SK40-HY20-110	20	42	50	110	73	52	M16x1

**Hydraulic Chuck, Standard**  
**液压刀柄, 标准型**

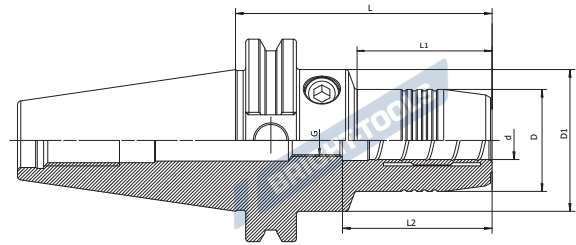
A ↗ ≤0.003	RPM G2.5/25000	AD/B
---------------	-------------------	------



Size	d	D	D1	L	L1	L2	G
SK50-HY06-80.5	06	26	50	80.5	39.5	38	M5
SK50-HY08-80.5	08	28	50	80.5	39.5	38	M6
SK50-HY10-80.5	10	30	50	80.5	40	42	M8x1
SK50-HY12-80.5	12	32	50	80.5	40.5	47	M10x1
SK50-HY16-80.5	16	38	49.5	80.5	40	50	M12x1
SK50-HY20-80.5	20	42	50	80.5	44	52	M16x1
SK50-HY25-80.5	25	57	70	80.5	43	58	M16x1
SK50-HY32-80.5	32	64	70	80.5	44	62	M16x1
SK50-HY06-110	06	26	49.5	110	30	38	M5
SK50-HY08-110	08	28	49.5	110	30	38	M6
SK50-HY10-110	10	30	49.5	110	32	42	M8x1
SK50-HY12-110	12	32	50	110	44	47	M10x1
SK50-HY16-110	16	38	49.5	110	40	50	M12x1
SK50-HY20-110	20	42	50	110	44	52	M16x1
SK50-HY25-110	25	27	70	110	70	58	M16x1
SK50-HY06-150	06	26	49.5	150	30	38	M5
SK50-HY08-150	08	28	49.5	150	30	38	M6
SK50-HY10-150	10	30	49.5	150	32	42	M8x1
SK50-HY12-150	12	32	49.5	150	35	47	M10x1
SK50-HY16-150	16	38	49.5	150	40	50	M12x1
SK50-HY20-150	20	42	50	150	44	52	M16x1

**HYDRO**



## Hydraulic Chuck, Standard

### 液压刀柄, 标准型

**HYDRO**

A ↗ ≤0.003	RPM G2.5/25000	AD
---------------	-------------------	----

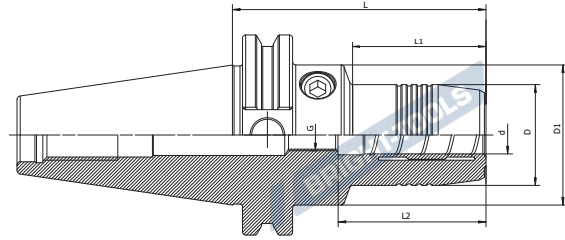

Size	d	D	D1	L	L1	L2	G
CAT40-HY06-81	06	26	49.5	81	30	38	M5
CAT40-HY08-81	08	28	49.5	81	30	38	M6
CAT40-HY10-81	10	30	49.5	81	31	42	M8x1
CAT40-HY12-81	12	32	49.5	81	31.5	47	M10x1
CAT40-HY16-81	16	38	49.5	81	33	50	M12x1
CAT40-HY20-81	20	42	49.5	81	34	52	M10x1
CAT40-HY25-81	25	55	66	81	22	58	M16x1
CAT40-HY32-81	32	63	80	81	25.5	62	M16x1
CAT40-HY06-110	06	26	49.5	110	29.5	38	M5
CAT40-HY08-110	08	28	49.5	110	30	38	M6
CAT40-HY10-110	10	30	49.5	110	31	42	M8x1
CAT40-HY12-110	12	32	49.5	110	31.5	47	M10x1
CAT40-HY16-110	16	38	49.5	110	33	50	M12x1
CAT40-HY20-110	20	42	49.5	110	34	52	M16x1
CAT50-HY06-81	06	26	49.5	81	30	38	M5
CAT50-HY08-81	08	28	49.5	81	30	38	M6
CAT50-HY10-81	10	30	49.5	81	32	42	M8x1
CAT50-HY12-81	12	32	49.5	81	35	47	M10x1
CAT50-HY16-81	16	38	49.5	81	40	50	M12x1
CAT50-HY20-81	20	42	49.5	81	40	52	M16x1

**Hydraulic Chuck, Standard**  
**液压刀柄, 标准型**



A ↗ ≤0.003	RPM G2.5/25000	AD
---------------	-------------------	----

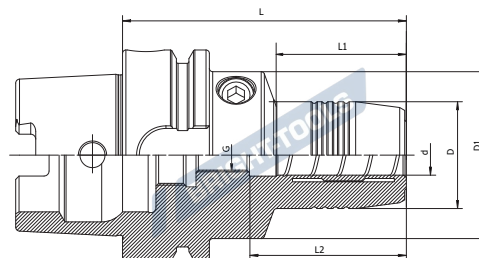

**HYDRO**

Size	d	D	D1	L	L1	L2	G
HSK32A-HY06-80	06	26	40	80	29	38	M5
HSK32A-HY08-80	08	28	40	80	29	38	M6
HSK32A-HY10-85	10	30	40	85	35	42	M6
HSK32A-HY12-90	12	32	40	90	40	47	M6
HSK40A-HY06-70	06	26	34	70	36	38	M5
HSK40A-HY08-70	08	28	34	70	36	38	M6
HSK40A-HY10-75	10	30	34	75	42	42	M6
HSK40A-HY12-80	12	32	34	80	48	47	M6
HSK50A-HY06-70	06	26	40	70	28	38	M5
HSK50A-HY08-70	08	28	40	70	28	38	M6
HSK50A-HY10-75	10	30	40	75	39	42	M8×1
HSK50A-HY12-85	12	32	40	85	44	47	M8×1
HSK50A-HY14-85	14	34	41	85	43.5	47	M8×1
HSK50A-HY16-90	16	38	53	90	30	50	M8×1
HSK50A-HY18-90	18	40	57	90	30	50	M8×1
HSK50A-HY20-90	20	42	60	90	29	52	M8×1
HSK63A-HY06-70	06	26	50	70	23	38	M5
HSK63A-HY08-70	08	28	50	70	23.5	38	M6
HSK63A-HY10-80	10	30	50	80	34	42	M8x1
HSK63A-HY12-85	12	32	50	85	39	47	M10x1
HSK63A-HY14-85	14	34	50	85	40	47	M10×1
HSK63A-HY16-90	16	38	50	90	45.5	50	M10×1
HSK63A-HY18-90	18	40	50	90	46	50	M10×1
HSK63A-HY20-90	20	42	50	90	46	52	M10×1
HSK63A-HY25-120	25	57	62	120	58	58	M16×1
HSK63A-HY32-125	32	64	-	125	-	62	M16×1

**BRIGHT-TOOLS**

**BRIGHT-TOOLS**

## Hydraulic Chuck, Standard

### 液压刀柄, 标准型

**HYDRO**

A ↗ ≤0.003	RPM G2.5/25000	AD
---------------	-------------------	----

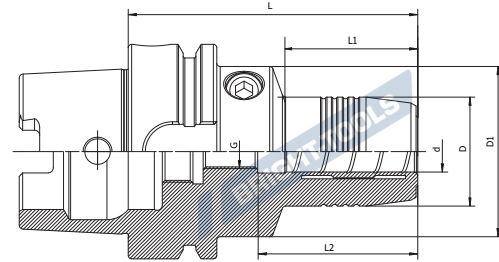

Size	d	D	D1	L	L1	L2	G
HSK63A-HY06-150	06	26	50	150	103	38	M5
HSK63A-HY08-150	08	28	50	150	104	38	M6
HSK63A-HY10-150	10	30	50	150	104	42	M8x1
HSK63A-HY12-150	12	32	50	150	104	47	M10x1
HSK63A-HY14-150	14	34	50	150	105	47	M10x1
HSK63A-HY16-150	16	38	50	150	105	50	M12x1
HSK63A-HY18-150	18	40	50	150	106	50	M12x1
HSK63A-HY20-150	20	42	50	150	106	52	M16x1
HSK63A-HY25-150	25	57	62	150	88	58	M16x1
HSK63A-HY32-150	32	64	70	150	88	62	M16x1
HSK63A-HY06-200	06	26	50	200	153	38	M5
HSK63A-HY08-200	08	28	50	200	154	38	M6
HSK63A-HY10-200	10	30	50	200	154	42	M8x1
HSK63A-HY12-200	12	32	50	200	154	47	M10x1
HSK63A-HY14-200	14	34	50	200	155	47	M12x1
HSK63A-HY16-200	16	38	50	200	155	50	M12x1
HSK63A-HY18-200	18	40	50	200	156	50	M12x1
HSK63A-HY20-200	20	42	50	200	156	52	M16x1
HSK63A-HY25-200	25	57	62	200	156	58	M16x1
HSK63A-HY32-200	32	64	70	200	156	62	M16x1
HSK80A-HY06-80	06	26	50	80	33	38	M5
HSK80A-HY12-95	12	32	50	95	49	47	M10x1
HSK80A-HY14-100	14	34	50	100	54.5	47	M10x1
HSK80A-HY16-100	16	38	50	100	55	50	M12x1
HSK80A-HY20-105	20	42	50	105	61	52	M12x1
HSK80A-HY25-110	25	57	63	110	64.5	58	M16x1
HSK80A-HY32-100	32	64	67	100	55	62	M10x1

## Hydraulic Chuck, Standard

### 液压刀柄, 标准型



A ↗ ≤0.003	RPM G2.5/25000	 AD
---------------	-------------------	---

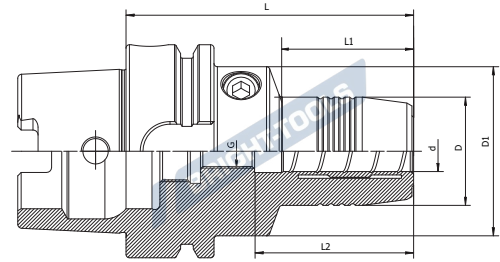

Size	d	D	D1	L	L1	L2	G
HSK100A-HY06-75	06	26	50	75	25	38	M5
HSK100A-HY08-75	08	28	50	75	25.5	38	M6
HSK100A-HY10-90	10	30	50	90	41	42	M8x1
HSK100A-HY12-95	12	32	50	95	46	47	M10x1
HSK100A-HY14-95	14	34	50	95	47	47	M10x1
HSK100A-HY16-100	16	38	50	100	52	50	M12x1
HSK100A-HY18-100	18	40	50	100	52.5	50	M12x1
HSK100A-HY20-105	20	42	60	105	54	52	M16x1
HSK100A-HY25-110	25	57	70	110	60	58	M16x1
HSK100A-HY32-110	32	64	70	110	61.5	62	M16x1
HSK100A-HY06-150	06	26	50	150	100	38	M5
HSK100A-HY08-150	08	28	50	150	100.5	38	M6
HSK100A-HY10-150	10	30	50	150	101	42	M8x1
HSK100A-HY12-150	12	32	50	150	101.5	47	M10x1
HSK100A-HY14-150	14	34	50	150	105.5	47	M12x1
HSK100A-HY16-150	16	38	50	150	105.5	50	M12x1
HSK100A-HY18-150	18	40	50	150	105.5	50	M12x1
HSK100A-HY20-150	20	42	60	150	99	52	M16x1
HSK100A-HY25-150	25	57	70	150	100	58	M16x1
HSK100A-HY32-150	32	64	70	150	102	62	M16x1
HSK100A-HY06-200	06	26	50	200	103.5	38	M5
HSK100A-HY08-200	08	28	50	200	104	38	M6
HSK100A-HY10-200	10	30	50	200	104.5	42	M8x1
HSK100A-HY12-200	12	32	50	200	104.5	47	M10x1
HSK100A-HY14-200	14	34	50	200	105.5	47	M12x1
HSK100A-HY16-200	16	38	50	200	105.5	50	M12x1
HSK100A-HY18-200	18	40	50	200	105.5	50	M12x1
HSK100A-HY20-200	20	42	60	200	149	52	M16x1
HSK100A-HY25-200	25	57	62	200	152	58	M16x1
HSK100A-HY32-200	32	64	70	200	152	62	M16x1
HSK125A-HY20-115	20	65	-	115	66	52	M16x1
HSK125A-HY32-125	32	80	-	125	76	62	M16x1

### Hydraulic Chuck, Standard

液压刀柄, 标准型

HYDRO



A ↗ ≤0.003	RPM G2.5/25000	AD
---------------	-------------------	----

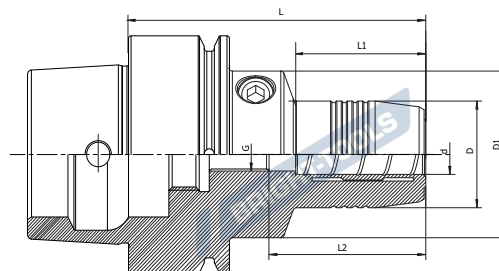

Size	d	D	D1	L	L1	L2	G
HSK40E-HY06-70	06	26	34	70	36	38	M5
HSK40E-HY08-70	08	28	34	70	36	38	M6
HSK40E-HY10-75	10	30	34	75	42	42	M6
HSK40E-HY12-80	12	32	34	80	48	47	M6
HSK50E-HY06-70	06	26	40	70	28	38	M5
HSK50E-HY08-70	08	28	40	70	28	38	M6
HSK50E-HY10-75	10	30	40	75	34	42	M8x1
HSK50E-HY12-85	12	32	40	85	44	47	M10x1
HSK50E-HY16-90	16	38	53	90	30	50	M12x1
HSK50E-HY20-90	20	42	60	90	29	52	M16x1

### Hydraulic Chuck, Standard

液压刀柄, 标准型



A ↗ ≤0.003	RPM G2.5	AD
---------------	-------------	----

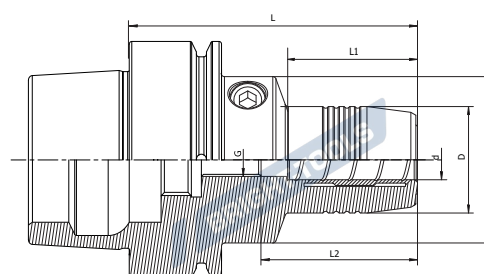

Size	d	D	D1	L	L1	L2	G
HSK63F-HY06-70	06	26	50	70	23	38	M5
HSK63F-HY08-70	08	28	50	70	23.5	38	M6
HSK63F-HY10-80	10	30	50	80	34	42	M8x1
HSK63F-HY12-85	12	32	50	85	39	47	M6
HSK63F-HY14-85	14	34	50	85	40	47	M10x1
HSK63F-HY16-90	16	38	50	90	45	50	M12x1
HSK63F-HY18-90	18	40	50	90	47	50	M12x1
HSK63F-HY20-90	20	42	50	90	46	52	M12x1
HSK63F-HY25-120	25	57	63	120	59	58	M16x1
HSK63F-HY32-125	32	64	75	125	63	62	M16x1

**Hydraulic Chuck, Short**  
 液压刀柄, 超短型



A ↗ ≤0.003	RPM G2.5/25000	AD
---------------	-------------------	----

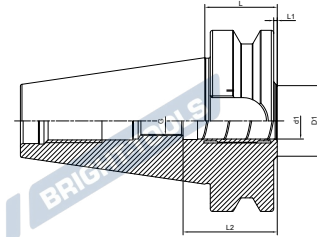

Size	d1	D1	L	L1	L2	G
BT40-HY20-32.5	20	34	32.5	5.5	52	-
BT50-HY20-40	20	39	40	2	52	M16x1

HYDRO

Tool Holder DIN 69871

**Hydraulic Chuck, Short**  
 液压刀柄, 超短型



A ↗ ≤0.003	RPM G2.5/25000	AD
---------------	-------------------	----

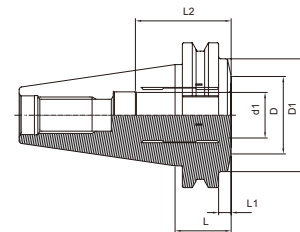

Size	d1	D1	D2	L	L1	L2	G
SK40-HY20-24.6	20	34	49.5	24.6	5.5	52	-
SK50-HY32-30.9	32	44.5	70.5	30.9	11.85	62	-

BRIGHT-TOOLS

BRIGHT-TOOLS

### Hydraulic Chuck, Power Design 液压刀柄, 强力型



$A \nearrow$ $\leq 0.003$	RPM G2.5/25000	 AD
------------------------------	-------------------	--------

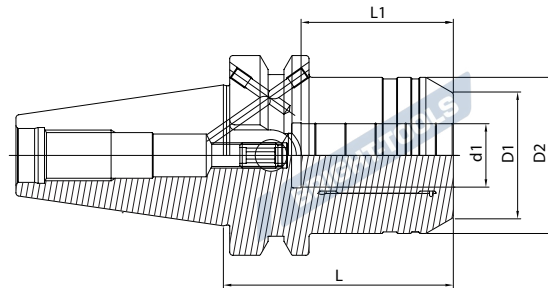

Size	d1	D1	D2	L	L1	G
BT30-HYP12-69	12	32	42	69	41	M8x1
BT30-HYP20-90	20	38	42	90	48	M8x1
BT40-HYP12-58	12	32	42	58	41	M8x1
BT40-HYP20-72.5	20	38	49.25	72.5	48	M8x1
BT50-HYP20-83.5	20	38	49.25	83.5	48	M8x1
BT50-HYP32-90	32	58.5	72	90	57	M8x1

### Tool Holder DIN 69871

### Hydraulic Chuck, Power Design 液压刀柄, 强力型



$A \nearrow$ $\leq 0.003$	RPM G2.5/25000	 AD
------------------------------	-------------------	--------

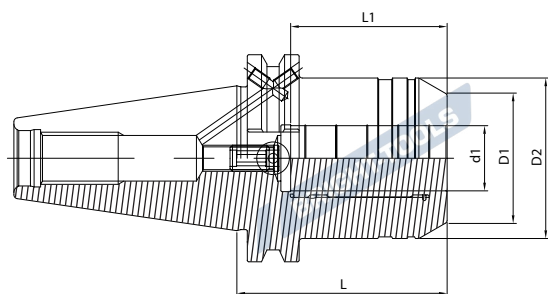

Size	d1	D1	D2	L	L1	G
SK40-HYP12-50	12	32	42	50	41	M8x1
SK40-HYP20-64.5	20	38	49.5	64.5	48	M8x1
SK50-HYP20-64.5	20	38	49.5	64.5	48	M8x1
SK50-HYP32-81	32	58.5	72	81	57	M8x1

**Hydraulic Chuck, Power Design**  
**液压刀柄, 强力型**

A ↗ ≤0.003	RPM G2.5/25000	AD
---------------	-------------------	----

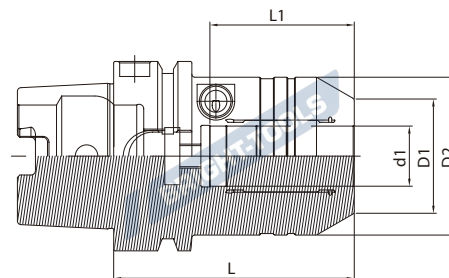

Size	d1	D1	D2	L	L1	G
HSK63A-HYP12-80	12	32	42	80	41	M8x1
HSK63A-HYP20-80	20	38	52.5	80	48	M8x1
HSK100A-HYP20-90	20	38	52.5	90	48	M8x1
HSK100A-HYP32-100	32	58.5	72	100	57	M8x1

**HYDRO**

BRIGHT-TOOLS

BRIGHT-TOOLS

BRIGHT-TOOLS

BRIGHT-TOOLS

BRIGHT-TOOLS

BRIGHT-TOOLS

## Hydraulic Chuck, for Mould 液压刀柄，模具型

A ↗  
≤0.003

RPM  
G2.5/25000

AD

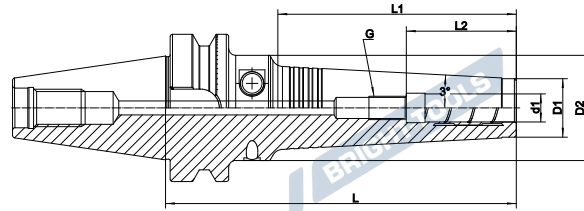

Size	d1	D1	D2	L	L1	L2	G
BT40-HYM06-120	06	20	44.5	120	70	38	M5
BT40-HYM06-150	06	20	44.5	150	100	38	M5
BT40-HYM08-120	08	22	44.5	120	70	38	M6
BT40-HYM08-150	08	22	44.5	150	100	38	M6
BT40-HYM10-120	10	24	44.5	120	70	42	M8×1
BT40-HYM10-150	10	24	44.5	150	100	42	M8×1
BT40-HYM12-120	12	25	44.5	120	70	47	M10×1
BT40-HYM12-150	12	25	44.5	150	100	47	M10×1
BT40-HYM16-120	16	32	44.5	120	70	50	M12×1
BT40-HYM16-150	16	32	44.5	150	100	50	M12×1
BT40-HYM20-120	20	34	43.8	120	93	52	M16×1
BT40-HYM20-150	20	34	46.9	150	123	52	M16×1
BT50-HYM06-150	06	20	50	150	90	38	M5
BT50-HYM08-150	08	22	50	150	90	38	M6
BT50-HYM10-150	10	24	50	150	90	42	M8×1
BT50-HYM12-150	12	25	50	150	90	47	M10×1
BT50-HYM16-150	16	32	50	150	90	50	M12×1
BT50-HYM20-150	20	34	50	150	90	52	M16×1

**Hydraulic Chuck, for Mould**  
**液压刀柄，模具型**

A ↗ ≤0.003	RPM G2.5/25000	AD
---------------	-------------------	----

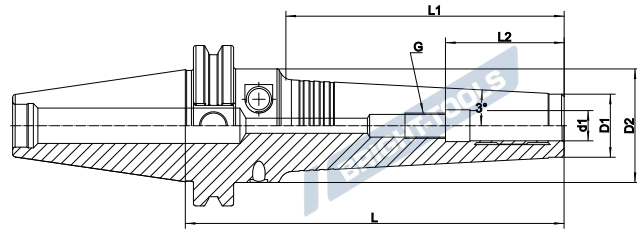

Size	d1	D1	D2	L	L1	L2	G
SK40-HYM06-120	06	20	49.5	120	70	38	M5
SK40-HYM06-150	06	20	49.5	150	100	38	M5
SK40-HYM08-120	08	22	49.5	120	70	38	M6
SK40-HYM08-150	08	22	49.5	150	100	38	M6
SK40-HYM10-120	10	24	44.5	120	70	42	M8×1
SK40-HYM10-150	10	24	44.5	150	100	42	M8×1
SK40-HYM12-120	12	25	44.5	120	70	47	M10×1
SK40-HYM12-150	12	25	44.5	150	100	47	M10×1
SK40-HYM16-120	16	32	49.5	120	70	50	M12×1
SK40-HYM16-150	16	32	49.5	150	100	50	M12×1
SK40-HYM20-120	20	34	49.5	120	70	52	M16×1
SK40-HYM20-150	20	34	49.5	150	100	52	M16×1
SK50-HYM06-150	06	20	44.5	150	100	38	M5
SK50-HYM08-150	08	22	44.5	150	100	38	M6
SK50-HYM10-150	10	24	44.5	150	100	42	M8×1
SK50-HYM12-150	12	25	44.5	150	100	47	M10×1
SK50-HYM16-150	16	32	44.5	150	100	50	M12×1
SK50-HYM20-150	20	34	44.5	150	100	52	M16×1

**HYDRO**

BRIGHT-TOOLS

BRIGHT-TOOLS

BRIGHT-TOOLS

BRIGHT-TOOLS

## Hydraulic Chuck, for Mould 液压刀柄, 模具型

A ↗ ≤0.003	RPM G2.5/25000	AD
---------------	-------------------	----

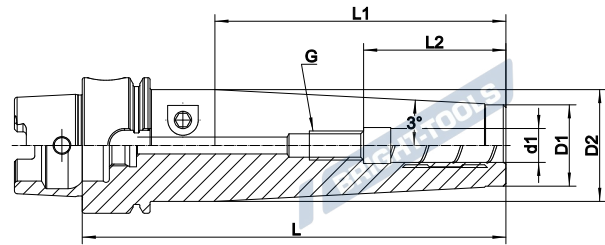

Size	d1	D1	D2	L	L1	L2	G
HSK63A-HYM06-145	06	20	50	145	90	38	M5
HSK63A-HYM08-145	08	22	50	145	90	38	M6
HSK63A-HYM10-145	10	24	50	145	90	42	M8×1
HSK63A-HYM12-145	12	25	50	145	90	47	M10×1
HSK63A-HYM16-145	16	32	50	145	90	50	M12×1
HSK63A-HYM20-145	20	34	50	145	90	52	M16×1
HSK100A-HYM06-150	06	20	50	150	90	38	M5
HSK100A-HYM08-150	08	22	50	150	90	38	M6
HSK100A-HYM10-150	10	24	50	150	90	42	M8×1
HSK100A-HYM12-150	12	25	50	150	90	47	M10×1
HSK100A-HYM16-150	16	32	50	150	90	50	M12×1
HSK100A-HYM20-150	20	34	50	150	90	52	M16×1

**Hydraulic Chuck, Slim**  
**液压刀柄, 细长型**

<b>A</b> ↗ ≤0.003	<b>RPM</b> G2.5/25000	<b>AD</b>
----------------------	--------------------------	-----------

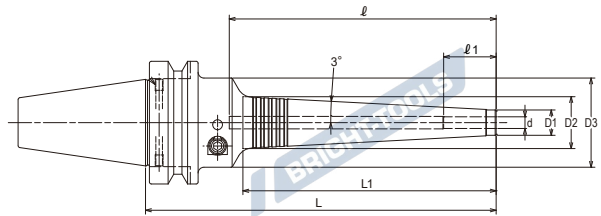

Size	d	L	L1	D1	D2	D3	l	l1
BT30-HYS03-70	03	70	28	11	14.0	46	93	16
BT30-HYS03-85	03	85	37	11	14.9	46	108	16
BT30-HYS03-130	03	130	84	11	19.9	46	153	16
BT30-HYS04-70	04	70	28	11	14.0	46	93	19
BT30-HYS04-85	04	85	37	11	14.9	46	108	19
BT30-HYS04-130	04	130	84	11	19.9	46	153	19
BT30-HYS06-90	06	90	38	13	17.0	46	58	27
BT30-HYS06-135	06	135	84	13	21.9	46	92	27
BT30-HYS06-150	06	150	99	13	23.4	46	107	27
BT30-HYS06-165	06	165	114	13	25.0	46	122	27
BT30-HYS06-180	06	180	130	13	26.7	46	137	27
BT30-HYS08-90	08	90	38	15	19.0	46	58	27
BT30-HYS08-135	08	135	84	15	23.9	46	92	27
BT30-HYS08-150	08	150	99	15	25.4	46	107	27
BT30-HYS08-165	08	165	114	15	27.0	46	122	27
BT30-HYS08-180	08	180	130	15	28.7	46	137	27
BT30-HYS10-105	10	105	53	17	22.6	46	73	33
BT30-HYS10-135	10	135	84	17	25.9	46	92	33
BT30-HYS10-150	10	150	99	17	27.4	46	107	33
BT30-HYS10-165	10	165	114	17	29.0	46	122	33
BT30-HYS10-180	10	180	130	17	30.7	46	137	33
BT30-HYS12-105	12	105	53	19	24.6	46	73	36
BT30-HYS12-135	12	135	84	19	27.9	46	92	36
BT30-HYS12-150	12	150	99	19	29.4	46	107	36
BT30-HYS12-165	12	165	114	19	31.0	46	122	36
BT30-HYS12-180	12	180	130	19	32.7	46	137	36

**HYDRO**



## Hydraulic Chuck, Slim 液压刀柄, 细长型

A ↗  
≤0.003

RPM  
G2.5/25000

 AD

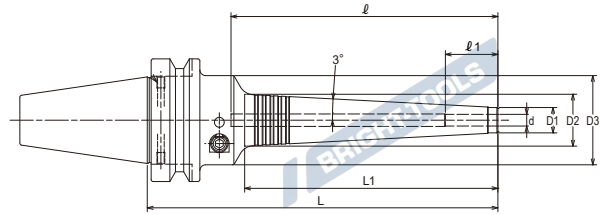

Size	d	L	L1	D1	D2	D3	ℓ	ℓ1
BT40-HYS03-75	03	75	28	11	14.0	46	110	16
BT40-HYS03-90	03	90	37	11	14.9	46	125	16
BT40-HYS03-135	03	135	84	11	19.9	46	170	16
BT40-HYS04-75	04	75	28	11	14.0	46	110	19
BT40-HYS04-90	04	90	37	11	14.9	46	125	19
BT40-HYS04-135	04	135	84	11	19.9	46	170	19
BT40-HYS06-90	06	90	38	13	17.0	46	53	27
BT40-HYS06-135	06	135	84	13	21.9	46	92	27
BT40-HYS06-150	06	150	99	13	23.4	46	107	27
BT40-HYS06-165	06	165	114	13	25.0	46	122	27
BT40-HYS06-180	06	180	130	13	26.7	46	137	27
BT40-HYS08-90	08	90	38	15	19.0	46	53	27
BT40-HYS08-135	08	135	84	15	23.9	46	92	27
BT40-HYS08-150	08	150	99	15	25.4	46	107	27
BT40-HYS08-165	08	165	114	15	27.0	46	122	27
BT40-HYS08-180	08	180	130	15	28.7	46	137	27
BT40-HYS10-105	10	105	53	17	22.6	46	68	33
BT40-HYS10-135	10	135	84	17	25.9	46	92	33
BT40-HYS10-150	10	150	99	17	27.4	46	107	33
BT40-HYS10-165	10	165	114	17	29.0	46	122	33
BT40-HYS10-180	10	180	130	17	30.7	46	137	33
BT40-HYS12-135	12	135	84	19	27.9	46	92	36
BT40-HYS12-150	12	150	99	19	29.4	46	107	36
BT40-HYS12-165	12	165	114	19	31.0	46	122	36
BT40-HYS12-180	12	180	130	19	32.7	46	137	36
BT40-HYS16-135	16	135	84	23	31.9	52.5	91	40
BT40-HYS16-165	16	165	114	23	35.0	52.5	120	40
BT40-HYS16-180	16	180	129	23	36.6	52.5	135	40
BT40-HYS20-135	20	135	84	28	36.9	60	91	40
BT40-HYS20-165	20	165	114	28	40	60	120	40
BT40-HYS20-180	20	180	129	28	41.6	60	135	40
BT40-HYS25-135	25	135	84	37	45.9	60	91	50
BT40-HYS25-165	25	165	114	37	49.0	60	120	50
BT40-HYS25-180	25	180	129	37	50.6	60	135	50

## Hydraulic Chuck, Slim 液压刀柄, 细长型

<b>A</b> ↗ ≤0.003	<b>RPM</b> G2.5/25000	<b>AD</b>
----------------------	--------------------------	-----------

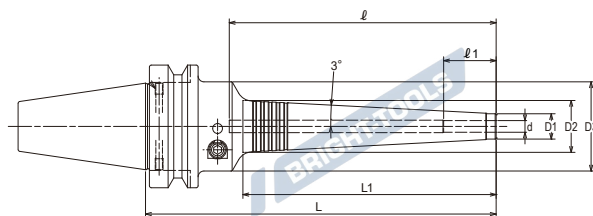

Size	d	L	L1	D1	D2	D3	ℓ	ℓ1
BT50-HYS06-105	06	105	38	13	17.0	46	53	27
BT50-HYS06-150	06	150	84	13	21.9	46	92	27
BT50-HYS06-165	06	165	99	13	23.4	46	107	27
BT50-HYS06-180	06	180	114	13	25.0	46	122	27
BT50-HYS06-195	06	195	130	13	26.7	46	137	27
BT50-HYS08-105	08	105	38	15	19.0	46	53	27
BT50-HYS08-150	08	150	84	15	23.9	46	92	27
BT50-HYS08-165	08	165	99	15	25.4	46	107	27
BT50-HYS08-180	08	180	114	15	27.0	46	122	27
BT50-HYS08-195	08	195	130	15	28.7	46	137	27
BT50-HYS10-150	10	150	84	17	25.9	46	92	33
BT50-HYS10-165	10	165	99	17	27.4	46	107	33
BT50-HYS10-180	10	180	114	17	29.0	46	122	33
BT50-HYS10-195	10	195	130	17	30.7	46	137	33
BT50-HYS12-150	12	150	84	19	27.9	46	92	36
BT50-HYS12-165	12	165	99	19	29.4	46	107	36
BT50-HYS12-180	12	180	114	19	31.0	46	122	36
BT50-HYS12-195	12	195	130	19	32.7	46	137	36
BT50-HYS16-150	16	150	84	23	31.9	52.5	91	40
BT50-HYS16-180	16	180	114	23	35.0	52.5	120	40
BT50-HYS16-195	16	195	129	23	36.6	52.5	135	40
BT50-HYS20-150	20	150	84	28	36.9	60	91	40
BT50-HYS20-180	20	180	114	28	40.0	60	120	40
BT50-HYS20-195	20	195	129	28	41.6	60	135	40
BT50-HYS25-150	25	150	84	37	45.9	60	91	50
BT50-HYS25-180	25	180	114	37	49.0	60	120	50
BT50-HYS25-195	25	195	129	37	50.6	60	135	50

**HYDRO**



## Hydraulic Chuck, Slim 液压刀柄, 细长型

HYDRO

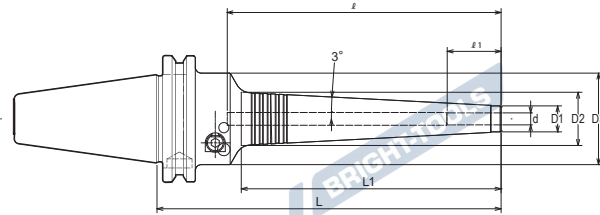
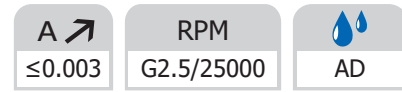

Size	d	D1	D2	D3	L	L1	L0	l1	l
SK40-HYS03-75	03	11	13.0	46	75	19	-	18	110
SK40-HYS03-90	03	11	14.2	46	90	30	-	18	125
SK40-HYS03-135	03	11	18.5	46	135	71	-	18	170
SK40-HYS04-75	04	11	13.0	46	75	19	-	24	110
SK40-HYS04-90	04	11	14.2	46	90	30	-	24	125
SK40-HYS04-135	04	11	18.5	46	135	71	-	24	170
SK40-HYS06-90	06	13	15.8	46	90	26	-	29	125
SK40-HYS06-135	06	13	20.5	46	135	71	-	29	170
SK40-HYS06-150	06	13	22.2	46	150	87	-	29	185
SK40-HYS06-165	06	13	23.7	46	165	102	-	29	200
SK40-HYS06-180	06	13	25.4	46	180	118	-	29	215
SK40-HYS08-90	08	15	17.9	46	90	27	-	29	125
SK40-HYS08-135	08	15	22.6	46	135	72	-	29	170
SK40-HYS08-150	08	15	24.2	46	150	87	-	29	185
SK40-HYS08-165	08	15	25.8	46	165	103	-	29	200
SK40-HYS08-180	08	15	27.4	46	180	118	-	29	215
SK40-HYS10-90	10	17	20.4	46	90	32	-	40	125
SK40-HYS10-135	10	17	24.6	46	135	72	-	40	170
SK40-HYS10-150	10	17	26.3	46	150	87	-	40	185
SK40-HYS10-165	10	17	27.8	46	165	103	-	40	200
SK40-HYS10-180	10	17	29.5	46	180	119	-	40	215
SK40-HYS12-90	12	19	22.5	46	90	33	-	40	125
SK40-HYS12-135	12	19	26.7	46	135	73	-	40	170
SK40-HYS12-150	12	19	28.3	46	150	88	-	40	185
SK40-HYS12-165	12	19	30.0	46	165	104	-	40	200
SK40-HYS12-180	12	19	31.5	46	180	119	-	40	215
SK40-HYS16-135	16	23	30.6	525	135	72	35	40	90
SK40-HYS16-165	16	23	33.8	525	165	103	35	40	120
SK40-HYS16-180	16	23	35.5	525	180	119	35	40	135
SK40-HYS20-150	20	28	34.7	62	150	63	35	40	85
SK40-HYS20-180	20	28	37.8	62	180	93	35	40	115
SK40-HYS20-195	20	28	39.5	62	195	109	35	40	130
SK40-HYS25-150	25	37	43.9	62	150	65	35	50	85
SK40-HYS25-180	25	37	47.1	62	180	96	35	50	115
SK40-HYS25-195	25	37	48.8	62	195	112	35	50	130

**Hydraulic Chuck, Slim**  
**液压刀柄, 细长型**

A ↗ ≤0.003	RPM G2.5/25000	AD
---------------	-------------------	----

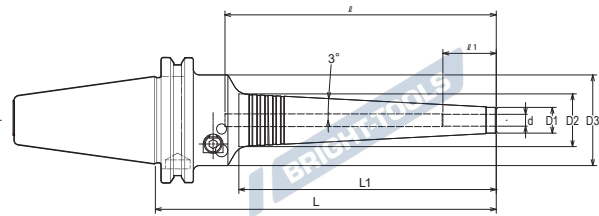

**HYDRO**

Size	d	D1	D2	D3	L	L1	l1	l
SK50-HYS06-105	06	13	15.8	46	105	26	29	161
SK50-HYS06-150	06	13	20.5	46	150	71	29	206
SK50-HYS06-165	06	13	22.2	46	165	87	29	221
SK50-HYS06-180	06	13	23.7	46	180	102	29	236
SK50-HYS06-195	06	13	25.4	46	195	118	29	251
SK50-HYS08-105	08	15	17.8	46	105	27	29	160
SK50-HYS08-150	08	15	22.5	46	150	72	29	205
SK50-HYS08-165	08	15	24.1	46	165	87	29	220
SK50-HYS08-180	08	15	25.8	46	180	103	29	235
SK50-HYS08-195	08	15	27.4	46	195	118	29	250
SK50-HYS10-150	10	17	24.6	46	150	72	40	205
SK50-HYS10-165	10	17	26.1	46	165	87	40	220
SK50-HYS10-180	10	17	27.8	46	180	103	40	235
SK50-HYS10-195	10	17	29.5	46	195	119	40	250
SK50-HYS12-150	12	19	26.7	46	150	73	40	205
SK50-HYS12-165	12	19	28.2	46	165	88	40	220
SK50-HYS12-180	12	19	29.9	46	180	104	40	235
SK50-HYS12-195	12	19	31.5	46	195	119	40	250
SK50-HYS16-150	16	23	30.5	52.5	150	72	40	90
SK50-HYS16-180	16	23	33.8	52.5	180	103	40	120
SK50-HYS16-195	16	23	34.6	52.5	195	119	40	135
SK50-HYS20-150	20	28	34.6	62	150	63	40	85
SK50-HYS20-180	20	28	37.7	62	180	93	40	115
SK50-HYS20-195	20	28	39.4	62	195	109	40	130
SK50-HYS25-150	25	37	43.6	62	150	65	50	85
SK50-HYS25-180	25	37	47.1	62	180	96	50	115
SK50-HYS25-195	25	37	48.7	62	195	112	50	130

**BRIGHT-TOOLS**

**BRIGHT-TOOLS**

## Hydraulic Chuck, Slim 液压刀柄, 细长型

**HYDRO**

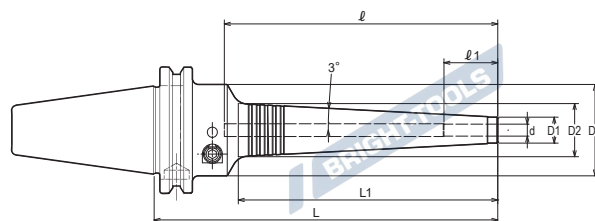

A ↗ ≤0.003	RPM G2.5/25000	AD
---------------	-------------------	----



Size	d	L	L1	D1	D2	D3	ℓ	ℓ1
CAT40-HYS03-75	03	75	28	11	14	46	110	16
CAT40-HYS03-90	03	90	37	11	14.9	46	125	16
CAT40-HYS03-135	03	135	84	11	19.9	46	170	16
CAT40-HYS04-75	04	75	28	11	14	46	110	19
CAT40-HYS04-90	04	90	37	11	14.9	46	125	19
CAT40-HYS04-135	04	135	84	11	19.9	46	170	19
CAT40-HYS06-90	06	90	38	13	17	46	53	27
CAT40-HYS06-150	06	150	84	13	21.9	46	92	27
CAT40-HYS06-165	06	165	99	13	23.4	46	107	27
CAT40-HYS06-180	06	180	114	13	25	46	122	27
CAT40-HYS06-195	06	195	130	13	26.7	46	137	27
CAT40-HYS08-90	08	90	38	15	19	46	53	27
CAT40-HYS08-150	08	150	84	15	23.9	46	92	27
CAT40-HYS08-165	08	165	99	15	25.4	46	107	27
CAT40-HYS08-180	08	180	114	15	27	46	122	27
CAT40-HYS08-195	08	195	130	15	28.7	46	137	27
CAT40-HYS10-105	10	105	53	17	22.6	46	68	33
CAT40-HYS10-150	10	150	84	17	25.9	46	92	33
CAT40-HYS10-165	10	165	99	17	27.4	46	107	33
CAT40-HYS10-180	10	180	114	17	29	46	122	33
CAT40-HYS10-195	10	195	130	17	30.7	46	137	33
CAT40-HYS12-105	12	105	53	19	24.6	46	68	36
CAT40-HYS12-150	12	150	84	19	27.9	46	92	36
CAT40-HYS12-165	12	165	99	19	29.4	46	107	36
CAT40-HYS12-180	12	180	114	19	31	46	122	36
CAT40-HYS12-195	12	195	130	19	32.7	46	137	36
CAT40-HYS16-150	16	150	84	23	31.9	52.5	91	40
CAT40-HYS16-180	16	180	114	23	35	52.5	120	40
CAT40-HYS16-195	16	195	129	23	38.6	52.5	135	40
CAT40-HYS20-150	20	150	84	28	36.9	60	91	40
CAT40-HYS20-180	20	180	114	28	40	60	120	40
CAT40-HYS20-195	20	195	129	28	41	60	135	40
CAT40-HYS25-150	25	150	84	37	45.9	60	91	50
CAT40-HYS25-180	25	180	114	37	49	60	120	50
CAT40-HYS25-195	25	195	129	37	50.6	60	135	50

**Hydraulic Chuck, Slim**  
**液压刀柄, 细长型**

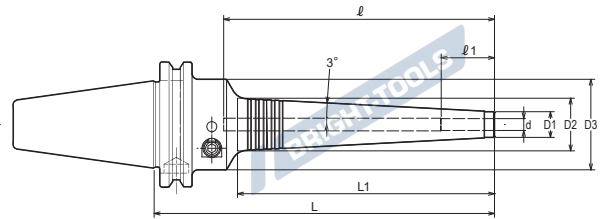
A ↗ ≤0.003	RPM G2.5/25000	AD
---------------	-------------------	----



Size	d	L	L1	L2	D1	D2	D3	l	l1
CAT50-HYS06-150	06	150	84	115	13	21.9	46	92	27
CAT50-HYS06-195	06	195	130	160	13	26.7	46	137	27
CAT50-HYS08-150	08	150	84	115	15	23.9	46	92	27
CAT50-HYS08-195	08	195	130	160	15	28.7	46	137	27
CAT50-HYS10-150	10	150	84	115	17	25.9	46	92	33
CAT50-HYS10-195	10	195	130	160	17	30.7	46	137	33
CAT50-HYS12-150	12	150	84	115	19	27.9	46	92	36
CAT50-HYS12-195	12	195	130	160	19	32.7	46	137	36
CAT50-HYS16-150	16	150	84	115	23	31.9	52.5	91	40
CAT50-HYS16-195	16	195	129	160	23	36.6	52.5	135	40
CAT50-HYS20-150	20	150	84	115	28	36.9	60	91	40
CAT50-HYS20-195	20	195	129	160	28	41.6	60	135	40
CAT50-HYS25-150	25	150	84	115	37	45.9	60	91	50
CAT50-HYS25-195	25	195	129	160	37	50.6	60	135	50

HYDRO



## Hydraulic Chuck, Slim 液压刀柄, 细长型

A ↗ ≤0.003	RPM G2.5/25000	AD
---------------	-------------------	----

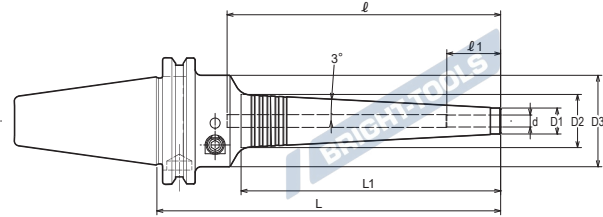

Size	d	L	L1	D1	D2	D3	L	ℓ1
CAT40-HYS1/8"-90	1/8"	3.543"	1.457"	0.433"	0.5"	1.811"	4.921"	0.63"
CAT40-HYS1/8"-135	1/8"	5.315"	3.307"	0.433"	0.783"	1.811"	6.692"	0.63"
CAT40-HYS1/4"-150	1/4"	5.906"	3.307"	0.512"	0.862"	1.811"	3.622"	1.063"
CAT40-HYS1/4"-165	1/4"	6.496"	3.898"	0.512"	0.921"	1.811"	4.213"	1.063"
CAT40-HYS1/4"-195	1/4"	7.677"	5.118"	0.512"	1.051"	1.811"	5.394"	1.063"
CAT40-HYS5/16"-150	5/16"	5.906"	3.307"	0.591"	0.941"	1.811"	3.622"	1.063"
CAT40-HYS5/16"-165	5/16"	6.496"	3.898"	0.591"	1"	1.811"	4.213"	1.063"
CAT40-HYS5/16"-195	5/16"	7.677"	5.118"	0.591"	1.13"	1.811"	5.394"	1.063"
CAT40-HYS3/8"-150	3/8"	5.906"	3.307"	0.669"	1.02"	1.811"	3.622"	1.299"
CAT40-HYS3/8"-165	3/8"	6.496"	3.898"	0.669"	1.079"	1.811"	4.213"	1.299"
CAT40-HYS3/8"-195	3/8"	7.677"	5.118"	0.669"	1.209"	1.811"	5.394"	1.299"
CAT40-HYS1/2"-150	1/2"	5.906"	3.307"	0.787"	1.138"	1.811"	3.622"	1.417"
CAT40-HYS1/2"-165	1/2"	6.496"	3.898"	0.787"	1.197"	1.811"	4.213"	1.417"
CAT40-HYS1/2"-195	1/2"	7.677"	5.118"	0.787"	1.327"	1.811"	5.394"	1.417"
CAT40-HYS5/8"-150	5/8"	5.906"	3.307"	0.906"	1.256"	2.067"	3.583"	1.575"
CAT40-HYS5/8"-180	5/8"	7.087"	4.488"	0.906"	1.378"	2.067"	4.724"	1.575"
CAT40-HYS5/8"-195	5/8"	7.677"	5.079"	0.906"	1.441"	2.067"	5.315"	1.575"
CAT40-HYS3/4"-150	3/4"	5.906"	3.307"	1.102"	1.453"	2.362"	3.583"	1.575"
CAT40-HYS3/4"-180	3/4"	7.087"	4.488"	1.102"	1.575"	2.362"	4.724"	1.575"
CAT40-HYS3/4"-195	3/4"	7.677"	5.079"	1.102"	1.638"	2.362"	5.315"	1.575"
CAT40-HYS1"-150	1"	5.906"	3.307"	1.496"	1.846"	2.362"	3.583"	1.969"
CAT40-HYS1"-180	1"	7.087"	4.488"	1.496"	1.969"	2.362"	4.724"	1.969"
CAT40-HYS1"-195	1"	7.677"	5.079"	1.496"	2.031"	2.362"	5.315"	1.969"

**Hydraulic Chuck, Slim**  
**液压刀柄, 细长型**

A ↗ ≤0.003	RPM G2.5/25000	AD
---------------	-------------------	----

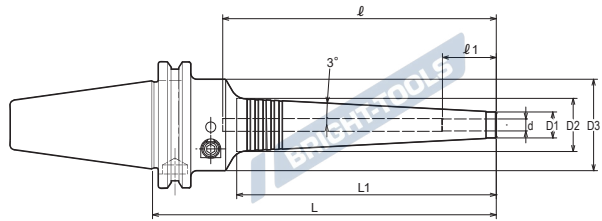

Size	d	L	L1	L2	D1	D2	D3	l	l1
CAT50-HYS1/4"-150	1/4"	5.906"	3.307"	4.528"	0.512"	0.862"	1.811"	3.622"	1.063"
CAT50-HYS1/4"-180	1/4"	7.087"	4.488"	5.709"	0.512"	1.051"	1.811"	4.803"	1.063"
CAT50-HYS1/4"-195	1/4"	7.677"	5.118"	6.299"	0.512"	1.051"	1.811"	5.394"	1.063"
CAT50-HYS5/16"-150	5/16"	5.906"	3.307"	4.528"	0.591"	0.941"	1.811"	3.622"	1.063"
CAT50-HYS5/16"-180	5/16"	7.087"	4.488"	5.709"	0.591"	1.13"	1.811"	4.803"	1.063"
CAT50-HYS5/16"-195	5/16"	7.677"	5.118"	6.299"	0.591"	1.13"	1.811"	5.394"	1.063"
CAT50-HYS3/8"-150	3/8"	5.906"	3.307"	4.528"	0.669"	1.02"	1.811"	4.803"	1.299"
CAT50-HYS3/8"-180	3/8"	7.087"	4.488"	5.709"	0.669"	1.209"	1.811"	5.394"	1.299"
CAT50-HYS3/8"-195	3/8"	7.677"	5.118"	6.299"	0.669"	1.209"	1.811"	5.394"	1.299"
CAT50-HYS1/2"-150	1/2"	5.906"	3.307"	4.528"	0.787"	1.138"	1.811"	3.622"	1.417"
CAT50-HYS1/2"-180	1/2"	7.087"	4.488"	5.709"	0.787"	1.26"	1.811"	4.803"	1.417"
CAT50-HYS1/2"-195	1/2"	7.677"	5.118"	6.299"	0.787"	1.327"	1.811"	5.394"	1.417"
CAT50-HYS5/8"-150	5/8"	5.906"	3.307"	4.528"	0.906"	1.256"	2.067"	3.583"	1.575"
CAT50-HYS5/8"-180	5/8"	7.087"	4.488"	5.709"	0.906"	1.441"	2.067"	4.724"	1.575"
CAT50-HYS5/8"-195	5/8"	7.677"	5.079"	6.299"	0.906"	1.441"	2.067"	5.315"	1.575"
CAT50-HYS3/4"-150	3/4"	5.906"	3.307"	4.528"	1.102"	1.453"	2.362"	3.583"	1.575"
CAT50-HYS3/4"-180	3/4"	7.087"	4.488"	5.709"	1.102"	1.638"	2.362"	4.724"	1.575"
CAT50-HYS3/4"-195	3/4"	7.677"	5.079"	6.299"	1.102"	1.638"	2.362"	5.315"	1.575"
CAT50-HYS1"-150	1"	5.906"	3.307"	4.528"	1.496"	1.846"	2.362"	3.583"	1.969"
CAT50-HYS1"-180	1"	7.087"	4.488"	5.709"	1.496"	1.969"	2.362"	4.724"	1.969"
CAT50-HYS1"-195	1"	7.677"	5.079"	6.299"	1.496"	2.031"	2.362"	5.315"	1.969"

HYDRO



### Hydraulic Chuck, Slim 液压刀柄, 细长型

A ↗	RPM	
≤0.003	G2.5/25000	AD

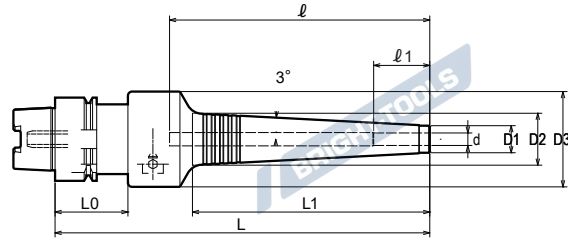

Size	d	L	L1	D1	D2	D3	L0	ℓ1	ℓ2
HSK40A-HYS03-90	03	90	28	11	14.0	46	35	74	16
HSK40A-HYS03-100	03	100	37	11	14.9	46	35	84	16
HSK40A-HYS03-145	03	145	84	11	19.9	46	35	129	16
HSK40A-HYS04-90	04	90	28	11	14.0	46	35	74	19
HSK40A-HYS04-100	04	100	37	11	14.9	46	35	84	19
HSK40A-HYS04-145	04	145	84	11	19.9	46	35	129	19
HSK40A-HYS06-105	06	105	38	13	17.0	46	35	55	27
HSK40A-HYS06-150	06	150	84	13	21.9	46	35	97	27
HSK40A-HYS06-165	06	165	99	13	23.4	46	35	112	27
HSK40A-HYS06-180	06	180	114	13	25.0	46	35	127	27
HSK40A-HYS08-105	08	105	38	15	19.0	46	35	55	27
HSK40A-HYS08-150	08	150	84	15	23.9	46	35	97	27
HSK40A-HYS08-165	08	165	99	15	25.4	46	35	112	27
HSK40A-HYS08-180	08	180	114	15	27.0	46	35	127	27
HSK40A-HYS10-120	10	120	53	17	22.6	46	35	69	33
HSK40A-HYS10-150	10	150	84	17	25.9	46	35	97	33
HSK40A-HYS10-165	10	165	99	17	27.4	46	35	112	33
HSK40A-HYS10-180	10	180	114	17	29.0	46	35	127	33
HSK40A-HYS12-120	12	120	53	19	24.6	46	35	69	36
HSK40A-HYS12-150	12	150	84	19	27.9	46	35	97	36
HSK40A-HYS12-165	12	165	99	19	29.4	46	35	112	36
HSK40A-HYS12-180	12	180	114	19	31.0	46	35	127	36

**Hydraulic Chuck, Slim**  
**液压刀柄, 细长型**

A ↗ ≤0.003	RPM G2.5/25000	AD
---------------	-------------------	----

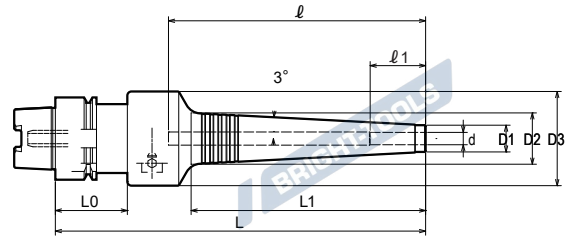

Size	d	L	L1	D1	D2	D3	L0	l1	l2
HSK50A-HYS03-95	03	95	28	11	14.0	46	42	75	16
HSK50A-HYS03-105	03	105	37	11	14.9	46	42	85	16
HSK50A-HYS03-150	03	150	84	11	19.9	46	42	130	16
HSK50A-HYS04-95	04	95	28	11	14.0	46	42	75	19
HSK50A-HYS04-105	04	105	37	11	14.9	46	42	85	19
HSK50A-HYS04-150	04	150	84	11	19.9	46	42	130	19
HSK50A-HYS06-105	06	105	38	13	17.0	46	42	53	27
HSK50A-HYS06-150	06	150	84	13	21.9	46	42	95	27
HSK50A-HYS06-165	06	165	99	13	23.4	46	42	110	27
HSK50A-HYS06-180	06	180	114	13	25.0	46	42	125	27
HSK50A-HYS08-105	08	105	38	15	19.0	46	42	53	27
HSK50A-HYS08-150	08	150	84	15	23.9	46	42	95	27
HSK50A-HYS08-165	08	165	99	15	25.4	46	42	110	27
HSK50A-HYS08-180	08	180	114	15	27.0	46	42	125	27
HSK50A-HYS10-120	10	120	53	17	22.6	46	42	67	33
HSK50A-HYS10-150	10	150	84	17	25.9	46	42	95	33
HSK50A-HYS10-165	10	165	99	17	27.4	46	42	110	33
HSK50A-HYS10-180	10	180	114	17	29.0	46	42	125	33
HSK50A-HYS12-120	12	120	53	19	24.6	46	42	67	36
HSK50A-HYS12-150	12	150	84	19	27.9	46	42	95	36
HSK50A-HYS12-165	12	165	99	19	29.4	46	42	110	36
HSK50A-HYS12-180	12	180	114	19	31.0	46	42	125	36

**HYDRO**



## Hydraulic Chuck, Slim 液压刀柄, 细长型

 A ↗  
≤0.003

 RPM  
G2.5/25000

AD

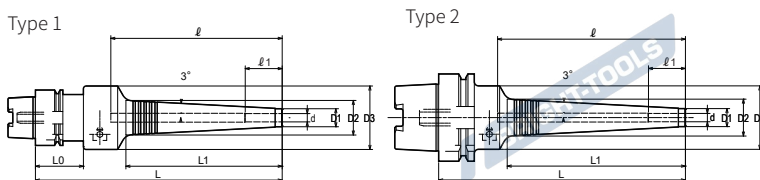

Size	Type	d	L	L1	D1	D2	D3	L0	ℓ	ℓ1
HSK63A-HYS03-80	2	03	80	28	11	14.0	46	-	58	16
HSK63A-HYS03-90	2	03	90	37	11	14.9	46	-	68	16
HSK63A-HYS03-135	2	03	135	84	11	19.9	46	-	113	16
HSK63A-HYS04-80	2	04	80	28	11	14.0	46	-	58	19
HSK63A-HYS04-90	2	04	90	37	11	14.9	46	-	68	19
HSK63A-HYS04-135	2	04	135	84	11	19.9	46	-	113	19
HSK63A-HYS06-90	2	06	90	38	13	17.0	46	-	53	27
HSK63A-HYS06-135	2	06	135	84	13	21.9	46	-	92	27
HSK63A-HYS06-150	2	06	150	99	13	23.4	46	-	107	27
HSK63A-HYS06-165	2	06	165	114	13	25.0	46	-	122	27
HSK63A-HYS06-180	2	06	180	130	13	26.7	46	-	137	27
HSK63A-HYS08-90	2	08	90	38	15	19.0	46	-	53	27
HSK63A-HYS08-135	2	08	135	84	15	23.9	46	-	92	27
HSK63A-HYS08-150	2	08	150	99	15	25.4	46	-	107	27
HSK63A-HYS08-165	2	08	165	114	15	27.0	46	-	122	27
HSK63A-HYS08-180	2	08	180	130	15	28.7	46	-	137	27
HSK63A-HYS10-105	2	10	105	53	17	22.6	46	-	67	33
HSK63A-HYS10-135	2	10	135	84	17	25.9	46	-	92	33
HSK63A-HYS10-150	2	10	150	99	17	27.4	46	-	107	33
HSK63A-HYS10-165	2	10	165	114	17	29.0	46	-	122	33
HSK63A-HYS10-180	2	10	180	130	17	30.7	46	-	137	33
HSK63A-HYS12-105	2	12	105	53	19	24.6	46	-	67	36
HSK63A-HYS12-135	2	12	135	84	19	27.9	46	-	92	36
HSK63A-HYS12-150	2	12	150	99	19	29.4	46	-	107	36
HSK63A-HYS12-165	2	12	165	114	19	31.0	46	-	122	36
HSK63A-HYS12-180	2	12	180	130	19	32.7	46	-	137	36
HSK63A-HYS16-135	2	16	135	84	23	31.9	52.5	-	91	40
HSK63A-HYS16-165	2	16	165	114	23	35.0	52.5	-	120	40
HSK63A-HYS16-180	2	16	180	129	23	36.6	52.5	-	135	40
HSK63A-HYS20-150	1	20	150	84	28	36.9	60	42	91	40
HSK63A-HYS20-180	1	20	180	114	28	40.0	60	42	120	40
HSK63A-HYS20-195	1	20	195	129	28	41.6	60	42	135	40
HSK63A-HYS25-150	1	25	150	84	37	45.9	60	42	91	50
HSK63A-HYS25-180	1	25	180	114	37	49.0	60	42	120	50
HSK63A-HYS25-195	1	25	195	129	37	50.6	60	42	135	50

**Hydraulic Chuck, Slim**  
**液压刀柄, 细长型**

A ↗ ≤0.003	RPM G2.5/25000	AD
---------------	-------------------	----

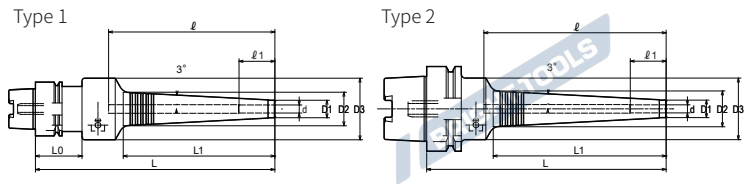

Size	Type	d	L	L1	D1	D2	D3	L0	l	l1
HSK100A-HYS06-105	2	06	105	38	13	17.0	46	-	53	27
HSK100A-HYS06-150	2	06	150	84	13	21.9	46	-	92	27
HSK100A-HYS06-165	2	06	165	99	13	23.4	46	-	107	27
HSK100A-HYS06-180	2	06	180	114	13	25.0	46	-	122	27
HSK100A-HYS06-195	2	06	195	130	13	26.7	46	-	137	27
HSK100A-HYS08-105	2	08	105	38	15	19.0	46	-	53	27
HSK100A-HYS08-150	2	08	150	84	15	23.9	46	-	92	27
HSK100A-HYS08-165	2	08	165	99	15	25.4	46	-	107	27
HSK100A-HYS08-180	2	08	180	114	15	27.0	46	-	122	27
HSK100A-HYS08-195	2	08	195	130	15	28.7	46	-	137	27
HSK100A-HYS10-150	2	10	150	84	17	25.9	46	-	92	33
HSK100A-HYS10-165	2	10	165	99	17	27.4	46	-	107	33
HSK100A-HYS10-180	2	10	180	114	17	29.0	46	-	122	33
HSK100A-HYS10-195	2	10	195	130	17	30.7	46	-	137	33
HSK100A-HYS12-150	2	12	150	84	19	27.9	46	-	92	36
HSK100A-HYS12-165	2	12	165	99	19	29.4	46	-	107	36
HSK100A-HYS12-180	2	12	180	114	19	31.0	46	-	122	36
HSK100A-HYS12-195	2	12	195	130	19	32.7	46	-	137	36
HSK100A-HYS16-150	2	16	150	84	23	31.9	52.5	-	91	40
HSK100A-HYS16-180	2	16	180	114	23	35.0	52.5	-	120	40
HSK100A-HYS16-195	2	16	195	129	23	36.6	52.5	-	135	40
HSK100A-HYS20-150	2	20	150	84	28	36.9	60	-	91	40
HSK100A-HYS20-180	2	20	180	114	28	40.0	60	-	120	40
HSK100A-HYS20-195	2	20	195	129	28	41.6	60	-	135	40
HSK100A-HYS25-150	2	25	150	84	37	45.9	60	-	91	50
HSK100A-HYS25-180	2	25	180	114	37	49.0	60	-	120	50
HSK100A-HYS25-195	2	25	195	129	37	50.6	60	-	135	50

**HYDRO**



## Hydraulic Chuck, Slim 直柄液压刀柄, 细长型

A ↗  
≤0.003



Type 1

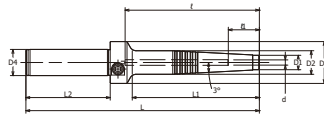

Type 2

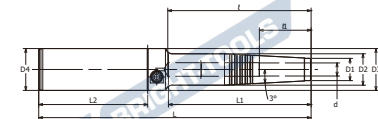

Size	Type	d	L	L1	L2	D1	D2	D3	D4	ℓ	ℓ1
C20-HYS03-180	1	03	180	98	65	11	18	32	20	103	16
C20-HYS04-180	1	04	180	98	65	11	18	32	20	103	19
C20-HYS06-180	1	06	180	99	65	13	20	32	20	103	27
C20-HYS08-180	1	08	180	99	65	15	22	32	20	101	27
C20-HYS10-180	1	10	180	100	65	17	24	32	20	101	33
C20-HYS12-180	1	12	180	100	65	19	26	32	20	101	36
C32-HYS06-210	2	06	210	109	84	13	20	32	32	113	27
C32-HYS08-210	2	08	210	109	84	15	22	32	32	111	27
C32-HYS10-210	2	10	210	110	84	17	24	32	32	111	33
C32-HYS12-210	2	12	210	110	84	19	26	32	32	111	36

### Hydraulic Chuck, for Grind 液压刀柄, 研磨机专用

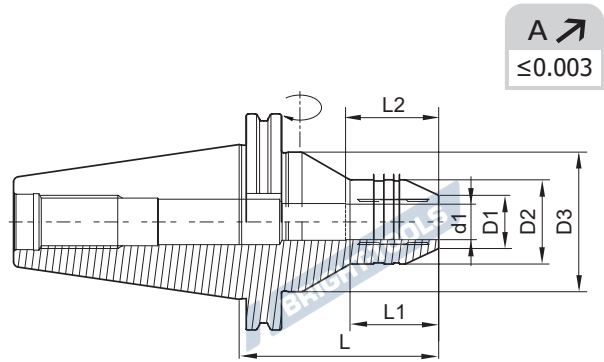

Size	d1	D1	D2	D3	L	L1	L2
SK50-HYG06-110	06	15	32	60	110	55	43
SK50-HYG08-110	08	17	33.5	60	110	55	43
SK50-HYG10-110	10	19	35	60	110	55	43
SK50-HYG12-110	12	21.5	36.5	60	110	55	50
SK50-HYG14-110	14	23.5	38	60	110	60	50
SK50-HYG16-110	16	25.5	39.5	60	110	60	53
SK50-HYG18-110	18	27.5	41	60	110	60	53
SK50-HYG20-110	20	28	42	70	110	47	95
SK50-HYG25-110	25	30	44	70	110	49	95
SK50-HYG32-110	32	40	54	70	110	62.5	95

### MTB Hydraulic Chuck 莫氏液压刀柄

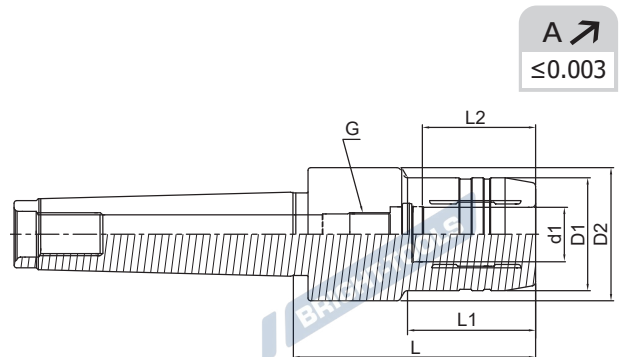

Size	d1	D1	D2	L	L1	L2	G
MTB4-HY20-90	20	42	49.5	90	47.5	52	M16×1
MTB4-HY32-90	32	72	72	90	-	62	-
MTB5-HY20-90	20	42	49.5	90	47.5	52	M16×1
MTB5-HY32-90	32	72	72	90	-	62	-

## Hydraulic Chuck for CNC Automatic Lathe

### 液压刀柄, 走心机专用

A ↗  
≤0.003



Type 1

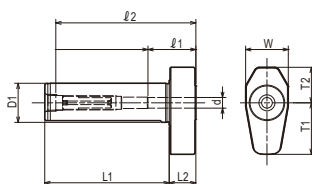

Type 2

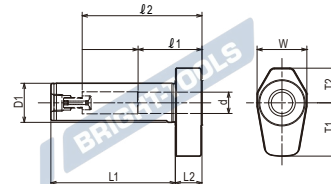

Size	Type	d	D1	L1	L2	W	T1	T2	l1	l2
ST16L-HY03-50	1	03	16	50	15	22	23	17.5	16	58
ST16L-HY04-50	1	04	16	50	15	22	23	17.5	19	58
ST16L-HY06-50	1	06	16	50	15	22	24.5	18.5	27	58
ST16L-HY08-50	2	08	16	50	15	24	25.5	19.5	27	47
ST20L-HY03-70	1	03	20	70	15	22	23	17.5	16	78
ST20L-HY04-70	1	04	20	70	15	22	23	17.5	19	78
ST20L-HY06-70	1	06	20	70	15	22	24.5	18.5	27	78
ST20L-HY08-70	2	08	20	70	15	24	25.5	19.5	27	64
ST20L-HY10-70	2	10	20	70	15	26	26.5	20.5	33	67
ST22L-HY03-70	1	03	22	70	15	24	23	17.5	16	78
ST22L-HY04-70	1	04	22	70	15	24	23	17.5	19	78
ST22L-HY06-70	1	06	22	70	15	24	24.5	18.5	27	78
ST22L-HY08-70	2	08	22	70	15	24	25.5	19.5	27	64
ST22L-HY10-70	2	10	22	70	15	26	26.5	20.5	33	67
ST22L-HY12-70	2	12	22	70	15	28	29	21.5	36	67
ST25L-HY03-70	1	03	25	70	15	28	23	17.5	16	78
ST25L-HY04-70	1	04	25	70	15	28	23	17.5	19	78
ST25L-HY06-70	1	06	25	70	15	28	24.5	18.5	27	78
ST25L-HY08-70	2	08	25	70	15	28	25.5	19.5	27	64
ST25L-HY10-70	2	10	25	70	15	28	26.5	20.5	33	67
ST25L-HY12-70	2	12	25	70	15	28	29	21.5	36	67
ST3/4"L-HY03-60	1	03	3/4"	60	15	22	23	17.5	16	68
ST3/4"L-HY04-60	1	04	3/4"	60	15	22	23	17.5	19	68
ST3/4"L-HY06-60	1	06	3/4"	60	15	22	24.5	18.5	27	68
ST3/4"L-HY08-60	2	08	3/4"	60	15	24	25.5	19.5	27	57
ST3/4"L-HY10-60	2	10	3/4"	60	15	26	26.5	20.5	33	60
ST1"L-HY03-70	1	03	1"	70	15	28	23	17.5	16	78
ST1"L-HY04-70	1	04	1"	70	15	28	23	17.5	19	78
ST1"L-HY06-70	1	06	1"	70	15	28	24.5	18.5	27	78
ST1"L-HY08-70	2	08	1"	70	15	28	25.5	19.5	27	64
ST1"L-HY10-70	2	10	1"	70	15	28	26.5	20.5	33	67
ST1"L-HY12-70	2	12	1"	70	15	28	29	21.5	36	67

## Hydraulic Collet, Sealed 液压筒夹, 止水型

A ↗  
≤0.003

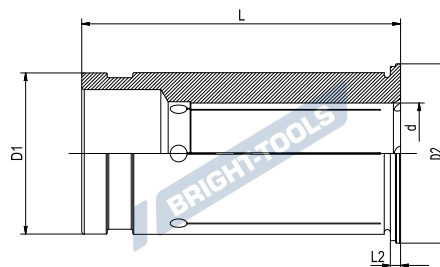

Size	d	D1	D2	L	L2
HY12S-03	03	12	16.5	47	2
HY12S-04	04	12	16.5	47	2
HY12S-05	05	12	16.5	47	2
HY12S-06	06	12	16.5	47	2
HY12S-07	07	12	16.5	47	2
HY12S-08	08	12	16.5	47	2
HY20S-03	03	20	24	52.5	2
HY20S-04	04	20	24	52.5	2
HY20S-05	05	20	24	52.5	2
HY20S-06	06	20	24	52.5	2
HY20S-07	07	20	24	52.5	2
HY20S-08	08	20	24	52.5	2
HY20S-09	09	20	24	52.5	2
HY20S-10	10	20	24	52.5	2
HY20S-11	11	20	24	52.5	2
HY20S-12	12	20	24	52.5	2
HY20S-13	13	20	24	52.5	2
HY20S-14	14	20	24	52.5	2
HY20S-15	15	20	24	52.5	2
HY20S-16	16	20	24	52.5	2

**HYDRO**

## Hydraulic Collet, Sealed 液压筒夹, 止水型

A ↗  
≤0.003

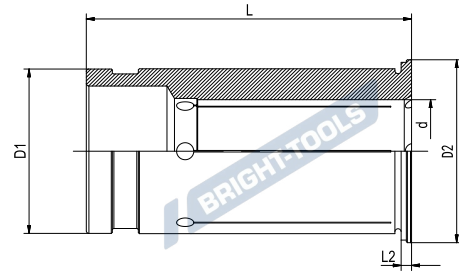

Size	d	D1	D2	L	L2
HY32S-06	06	32	35.5	62.5	2
HY32S-07	07	32	35.5	62.5	2
HY32S-08	08	32	35.5	62.5	2
HY32S-09	09	32	35.5	62.5	2
HY32S-10	10	32	35.5	62.5	2
HY32S-11	11	32	35.5	62.5	2
HY32S-12	12	32	35.5	62.5	2
HY32S-13	13	32	35.5	62.5	2
HY32S-14	14	32	35.5	62.5	2
HY32S-15	15	32	35.5	62.5	2
HY32S-16	16	32	35.5	62.5	2
HY32S-17	17	32	35.5	62.5	2
HY32S-18	18	32	35.5	62.5	2
HY32S-19	19	32	35.5	62.5	2
HY32S-20	20	32	35.5	62.5	2
HY32S-21	21	32	35.5	62.5	2
HY32S-22	22	32	35.5	62.5	2
HY32S-23	23	32	35.5	62.5	2
HY32S-24	24	32	35.5	62.5	2
HY32S-25	25	32	35.5	62.5	2

## Hydraulic Collet with Coolant Channels

液压筒夹，端面出水型

A ↗  
≤0.003

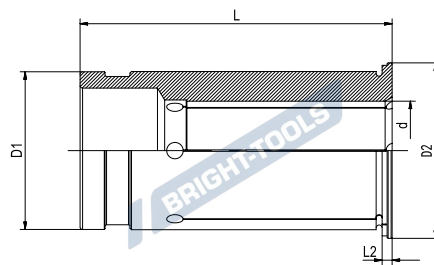

Size	d	D1	D2	L	L2
HY12S-03K	03	12	16.5	47	2
HY12S-04K	04	12	16.5	47	2
HY12S-05K	05	12	16.5	47	2
HY12S-06K	06	12	16.5	47	2
HY12S-07K	07	12	16.5	47	2
HY12S-08K	08	12	16.5	47	2
HY20S-03K	03	20	24	52.5	2
HY20S-04K	04	20	24	52.5	2
HY20S-05K	05	20	24	52.5	2
HY20S-06K	06	20	24	52.5	2
HY20S-07K	07	20	24	52.5	2
HY20S-08K	08	20	24	52.5	2
HY20S-09K	09	20	24	52.5	2
HY20S-10K	10	20	24	52.5	2
HY20S-11K	11	20	24	52.5	2
HY20S-12K	12	20	24	52.5	2
HY20S-13K	13	20	24	52.5	2
HY20S-14K	14	20	24	52.5	2
HY20S-15K	15	20	24	52.5	2
HY20S-16K	16	20	24	52.5	2

**HYDRO**

## Hydraulic Collet with Coolant Channels

### 液压筒夹，端面出水型

A ↗  
≤0.003

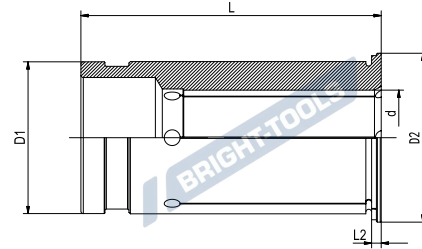

Size	d	D1	D2	L	L2
HY32S-06K	06	32	35.5	62.5	2
HY32S-07K	07	32	35.5	62.5	2
HY32S-08K	08	32	35.5	62.5	2
HY32S-09K	09	32	35.5	62.5	2
HY32S-10K	10	32	35.5	62.5	2
HY32S-11K	11	32	35.5	62.5	2
HY32S-12K	12	32	35.5	62.5	2
HY32S-13K	13	32	35.5	62.5	2
HY32S-14K	14	32	35.5	62.5	2
HY32S-15K	15	32	35.5	62.5	2
HY32S-16K	16	32	35.5	62.5	2
HY32S-17K	17	32	35.5	62.5	2
HY32S-18K	18	32	35.5	62.5	2
HY32S-19K	19	32	35.5	62.5	2
HY32S-20K	20	32	35.5	62.5	2
HY32S-21K	21	32	35.5	62.5	2
HY32S-22K	22	32	35.5	62.5	2
HY32S-23K	23	32	35.5	62.5	2
HY32S-24K	24	32	35.5	62.5	2
HY32S-25K	25	32	35.5	62.5	2

## Hydraulic Collet Set 液压筒夹套装



**HYDRO**

Size	Hydraulic chuck	Hydraulic Collet	Collet Quantity
BT40-HY12-90-5 PCS	BT40-HY12-90	HYS12-3,4,5,6,8	5
BT40-HY20-90-5 PCS	BT40-HY20-90	HYS20-6,8,10,12,16	5
BT40-HY32-105-7 PCS	BT40-HY32-105	HYS32-6,8,10,12,16,20,25	7
SK40-HY12-80.5-5 PCS	SK40-HY12-80.5	HYS12-3,4,5,6,8	5
SK40-HY20-80.5-5 PCS	SK40-HY20-80.5	HYS20-6,8,10,12,16	5
SK40-HY32-80.5-7 PCS	SK40-HY32-80.5	HYS32-6,8,10,12,16,20,25	7
CAT40-HY12-81-5 PCS	CAT40-HY12-81	HYS12-3,4,5,6,8	5
CAT40-HY20-81-5 PCS	CAT40-HY20-81	HYS20-6,8,10,12,16	5
CAT40-HY32-81-7 PCS	CAT40-HY32-81	HYS32-6,8,10,12,16,20,25	7
HSK63A-HY12-85-5 PCS	HSK63A-HY12-85	HYS12-3,4,5,6,8	5
HSK63A-HY20-90-5 PCS	HSK63A-HY20-90	HYS20-6,8,10,12,16	5
HSK63A-HY32-105-7 PCS	HSK63A-HY32-105	HYS32-6,8,10,12,16,20,25	7

**BRIGHT-TOOLS**

**BRIGHT-TOOLS**

**BRIGHT-TOOLS**

**BRIGHT-TOOLS**

## Hydraulic Chuck Set

### 液压刀柄套装



Size	Hydraulic chuck	Pull Stud	Spanner(mm)	Coolant tube
BT40-HY-8 PCS	BT40-HY06-90	BT40-45CO*8	T5	-
	BT40-HY08-90			
	BT40-HY10-90			
	BT40-HY12-90			
	BT40-HY16-90		T6	
	BT40-HY20-90			
	BT40-HY25-100			
	BT40-HY32-105			
SK40-HY-8 PCS	SK40-HY06-80.5	SK40A*8	T5	-
	SK40-HY08-80.5			
	SK40-HY10-80.5			
	SK40-HY12-80.5			
	SK40-HY16-80.5		T6	
	SK40-HY20-80.5			
	SK40-HY25-80.5			
	SK40-HY32-80.5			
CAT40-HY-8 PCS	CAT40-HY06-81	CAT40*8	T5	-
	CAT40-HY08-81			
	CAT40-HY10-81			
	CAT40-HY12-81			
	CAT40-HY16-81		T6	
	CAT40-HY20-81			
	CAT40-HY25-81			
	CAT40-HY32-81			
HSK63A-HY-8PCS	HSK63A-HY06-70	-	T5	CT63*8
	HSK63A-HY08-70			
	HSK63A-HY10-80			
	HSK63A-HY12-85			
	HSK63A-HY16-90		T6	
	HSK63A-HY20-90			
	HSK63A-HY25-120			
	HSK63A-HY32-125			