

BRIGHT-TOOLS

BRIGHT-TOOLS

TOOL HOLDERS

SHRINK

BRIGHT-TOOLS

BRIGHT-TOOLS

BRIGHT-TOOLS

BRIGHT-TOOLS

BRIGHT-TOOLS

BRIGHT-TOOLS

Shrink Fit Chuck Working Principle

热缩刀柄的工作原理

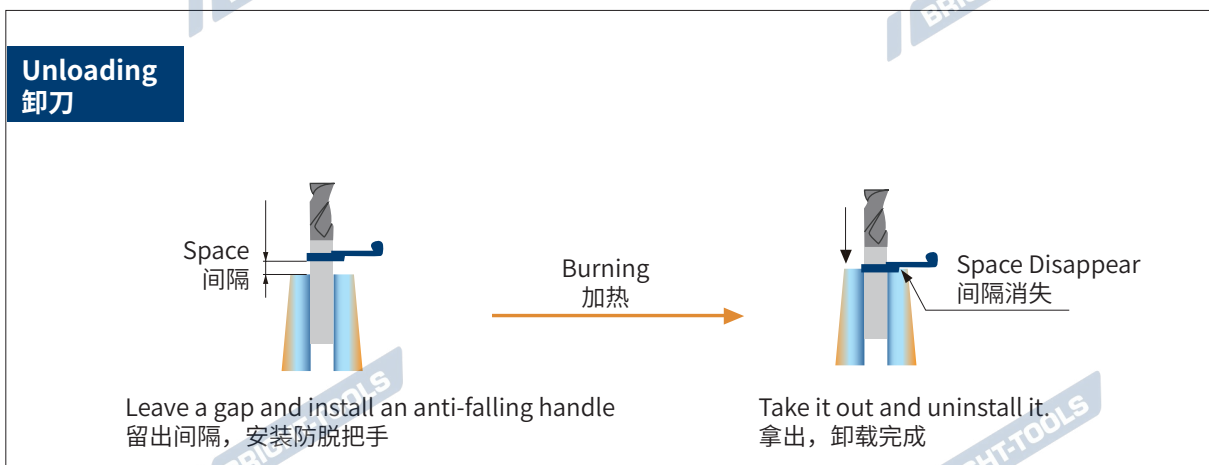
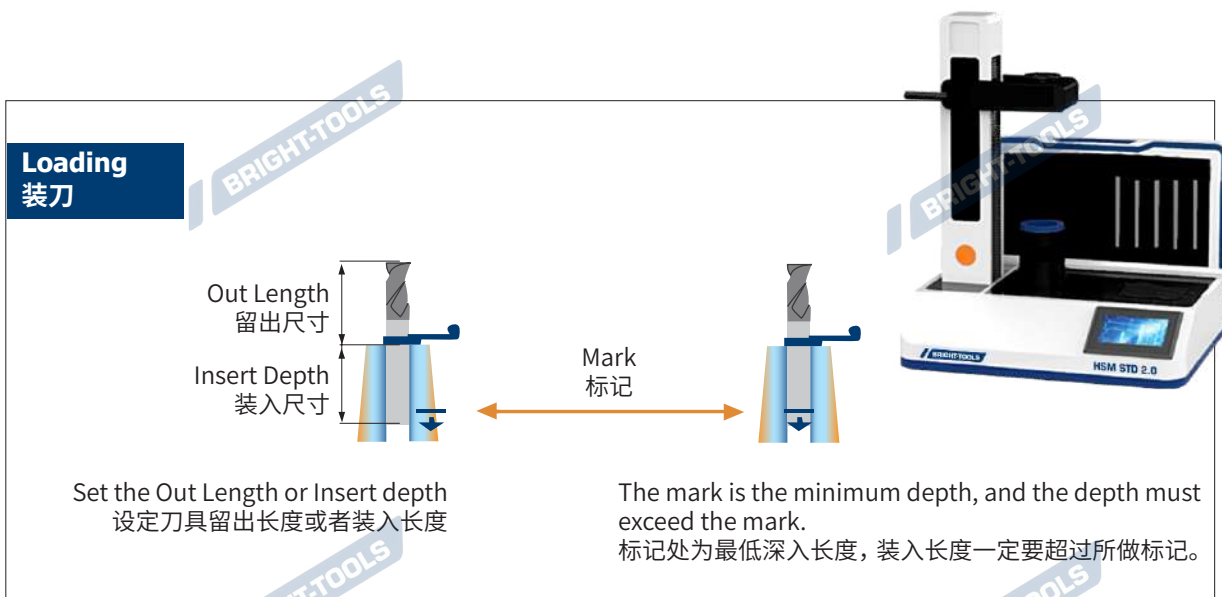
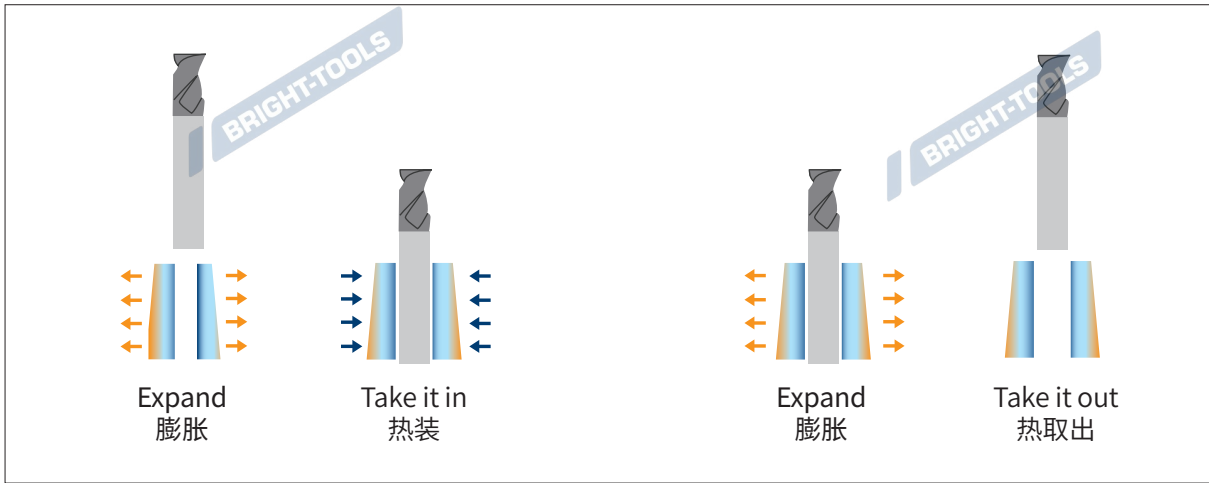

Shrink Fit Chuck Advantages 热缩刀柄加工优势

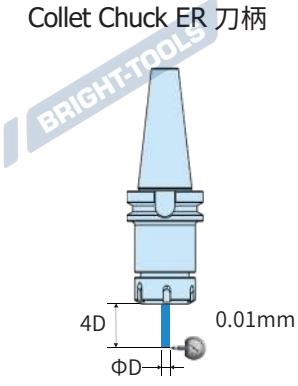
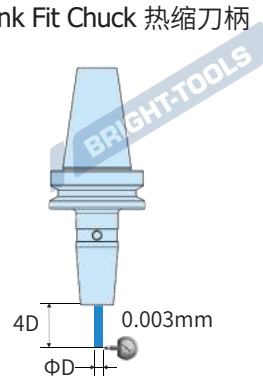
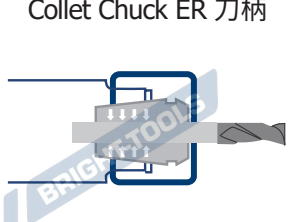
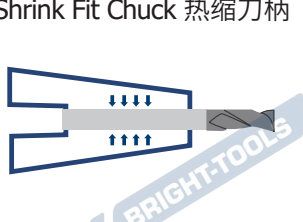
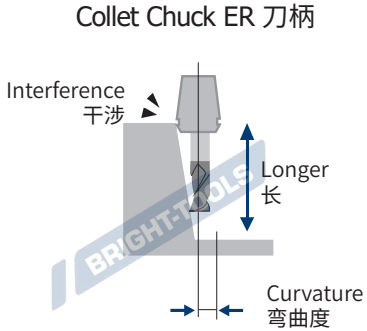
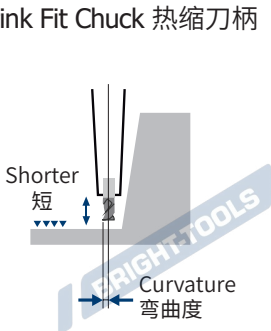
High Precision 高精度	High Precision 高精度
<p>Collet Chuck ER 刀柄</p>  <p>4D ϕD 0.01mm</p>	<p>Shrink Fit Chuck 热缩刀柄</p>  <p>4D ϕD 0.003mm</p>
High Clamping Force 高夹持力	High Clamping Force 高夹持力
<p>Collet Chuck ER 刀柄</p>  <p>Elastic Deformation 通过 ER 筒夹内部的变形来夹持刀具</p>	<p>Shrink Fit Chuck 热缩刀柄</p>  <p>Thermal Expansion Contractility 利用了热胀冷缩的原理来增加和稳定夹持力</p>
Deep Cavity Machining 深孔加工 防干涉	Deep Cavity Machining 深孔加工 防干涉
<p>Collet Chuck ER 刀柄</p>  <p>Interference 干涉 Longer 长 Curvature 弯曲度</p>	<p>Shrink Fit Chuck 热缩刀柄</p>  <p>Shorter 短 Curvature 弯曲度</p>

Shrink Fit Chuck Coolant Outlet Method 热缩刀柄出水方式

AD 中心出水



Face Outlet 端面出水



AD+B 中心 + 法兰出水



SHRINK TOOLING SYSTEM

热缩工具系统

SHRINK FIT 模具钢热缩

BT Shrink Fit Chuck, Standard, 4.5°	A.06
BT 热缩刀柄, 标准型	
BBT Shrink Fit Chuck, Standard, 4.5°	A.11
BBT 热缩刀柄, 标准型	
SK Shrink Fit Chuck, Standard, 4.5°	A.14
SK 热缩刀柄, 标准型	
CAT Shrink Fit Chuck, Standard, 4.5°	A.18
CAT 热缩刀柄, 标准型	
HSK-A Shrink Fit Chuck, Standard, 4.5°	A.23
HSK-A 热缩刀柄, 标准型	
HSK-E Shrink Fit Chuck, Standard, 4.5°	A.30
HSK-E 热缩刀柄, 标准型	
HSK-F Shrink Fit Chuck, Standard, 4.5°	A.32
HSK-F 热缩刀柄, 标准型	
BT Shrink Fit Chuck, 4.5°, Coolant	A.34
BT 热缩刀柄, 端面出水型	
BBT Shrink Fit Chuck, 4.5°, Coolant	A.36
BBT 热缩刀柄, 端面出水型	
SK Shrink Fit Chuck, 4.5°, Coolant	A.38
SK 热缩刀柄, 端面出水型	
CAT Shrink Fit Chuck, 4.5°, Coolant	A.40
CAT 热缩刀柄, 端面出水型	
HSK Shrink Fit Chuck, 4.5°, Coolant	A.45
HSK 热缩刀柄, 端面出水型	
MQL1 Shrink Fit Chuck	A.50
微润滑单通道热缩刀柄	
MQL2 Shrink Fit Chuck	A.53
微润滑双通道热缩刀柄	
BT Shrink Fit Chuck, Slim, 3°	A.60
BT 热缩刀柄 3 度, 细长型	
SK Shrink Fit Chuck, Slim, 3°	A.61
SK 热缩刀柄 3 度, 细长型	
CAT Shrink Fit Chuck, Slim, 3°	A.62
CAT 热缩刀柄 3 度, 细长型	
HSK-A Shrink Fit Chuck, Slim, 3°	A.63
HSK-A 热缩刀柄 3 度, 细长型	
HSK-E Shrink Fit Chuck, Slim, 3°	A.65
HSK-E 热缩刀柄 3 度, 细长型	
Shrink Fit Extension, 3°	A.67
3° 直柄热缩延长杆	
Shrink Fit ER Collet	A.70
ER 热缩夹头	
Shrink Fit ER Collet Extension	A.71
ER 热缩延长杆	
Shrink Chuck Set	A.72
热缩刀柄套装	
MQL1 Channel Length Setting Screws	A.73
微润滑单通道长度调节螺钉	
MQL2 Channel Length Setting Screws	A.60
微润滑双通道长度调节螺钉	
MQL1 Channel Coolant Supply Set	A.77
微润滑单通道冷却导管	
MQL2 Channel Coolant Supply Set	A.78
微润滑双通道冷却导管	

MODULAR SHRINK 分体热缩

BT Shrink Chuck Taper	A.83
BT 分体热缩本体, 标准型	
SK Shrink Chuck Taper	A.84
SK 分体热缩本体, 标准型	
HSK-A Shrink Chuck Taper	A.85
HSK-A 分体热缩本体, 标准型	
HSK-E Shrink Chuck Taper	A.86
HSK-E 分体热缩本体, 标准型	
HSK-F Shrink Chuck Taper	A.87
HSK-F 分体热缩本体, 标准型	
BT Shrink Chuck Taper, Coooolant	A.88
BT 分体热缩本体, 端面出水型	
SK Shrink Chuck Taper, Coooolant	A.88
SK 分体热缩本体, 端面出水型	
HSK Shrink Chuck Taper, Coooolant	A.89
HSK 分体热缩本体, 端面出水型	
Shrink Chuck Extension Slim	A.90
分体热缩延长杆, 细长型	
Shrink Chuck Extension, Standard	A.92
分体热缩延长杆, 标准型	
Shrink Chuck Extension, Coolant	A.93
分体热缩延长杆, 端面出水型	
Shrink Chuck Set	A.94
热缩刀柄套装	

STAINLESS SHRINK 不锈钢热缩

BT Shrink Chuck, 3°, Slim, Form A	A.97
BT 热缩刀柄 3 度, 薄壁 A 型	
HSK Shrink Chuck, 3°, Slim, Form A	A.103
HSK 热缩刀柄 3 度, 薄壁 A 型	
BT Shrink Chuck, 3°, Slim, Form B	A.114
BT 热缩刀柄 3 度, 薄壁 B 型	
HSK Shrink Chuck, 3°, Slim, Form B	A.122
HSK 热缩刀柄 3 度, 薄壁 B 型	
BT Shrink Chuck, 3°, Regular, Form A	A.132
BT 热缩刀柄 3 度, 标准 A 型	
HSK Shrink Chuck, 3°, Regular, Form A	A.136
HSK 热缩刀柄 3 度, 标准 A 型	
BT Shrink Chuck, 3°, Regular, Form B	A.145
BT 热缩刀柄 3 度, 标准 B 型	
HSK Shrink Chuck, 3°, Regular, Form B	A.151
HSK 热缩刀柄 3 度, 标准 B 型	
BT Shrink Chuck, 3°, Regular, Coolant	A.159
BT 热缩刀柄 3 度, 端面出水型	
HSK Shrink Chuck, 3°, Regular, Coolant	A.165
HSK 热缩刀柄 3 度, 端面出水型	
BT Shrink Chuck, Curved	A.174
BT 热缩刀柄, 曲线型	
HSK Shrink Chuck, Curved	A.181
HSK 热缩刀柄, 曲线型	

SHRINK FIT MACHINES 热缩机

Shrink Fit Machine, Standard	A.196
热缩机, 标准型	
Shrink Fit Machine Cooling Version	A.197
热缩机, 水冷型	

Shrink Fit Chuck, 4.5°, Standard

热缩刀柄, 标准型

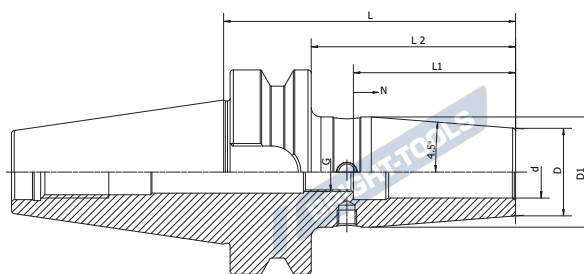
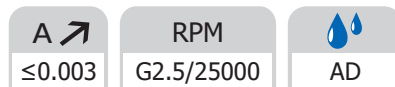

Size	d	D	D1	L	L2	L1	N	G
BT30-SF03-80	03	15	20	80	58	-	-	-
BT30-SF04-80	04	15	20	80	58	-	-	-
BT30-SF05-80	05	15	20	80	58	-	-	-
BT30-SF06-80	06	21	27	80	58	36	10	M5
BT30-SF08-80	08	21	27	80	58	36	10	M6
BT30-SF10-80	10	24	30.5	80	58	42	10	M8x1
BT30-SF12-80	12	24	30.5	80	58	47	10	M10x1
BT30-SF14-80	14	27	33.5	80	58	47	10	M10x1
BT30-SF16-80	16	27	33.5	80	58	50	10	M12x1
BT30-SF18-80	18	33	39.5	80	58	50	10	M12x1
BT30-SF20-80	20	33	39.5	80	58	52	10	M16x1
BT30-SF06-120	06	21	27	120	98	36	10	M5
BT30-SF08-120	08	21	27	120	98	36	10	M6
BT30-SF10-120	10	24	32	120	98	42	10	M8x1
BT30-SF12-120	12	24	32	120	98	47	10	M10x1
BT30-SF16-120	16	27	34	120	98	50	10	M12x1
BT30-SF20-120	20	33	42	120	98	52	10	M16x1
BT40-SF03-80	03	15	20	80	53	-	-	-
BT40-SF04-80	04	15	20	80	53	-	-	-
BT40-SF05-80	05	15	20	80	53	-	-	-
BT40-SF06-90	06	21	27	90	63	36	10	M5
BT40-SF08-90	08	21	27	90	63	36	10	M6
BT40-SF10-90	10	24	31	90	63	42	10	M8x1
BT40-SF12-90	12	24	31	90	63	47	10	M10x1
BT40-SF14-90	14	27	34	90	63	47	10	M10x1
BT40-SF16-90	16	27	34	90	63	50	10	M12x1
BT40-SF18-90	18	33	40	90	63	50	10	M12x1
BT40-SF20-90	20	33	40	90	63	52	10	M16x1
BT40-SF25-100	25	44	53	100	73	58	10	M16x1
BT40-SF32-100	32	44	53	100	73	62	10	M16x1
BT40-SF03-120	03	15	20	120	93	-	-	-
BT40-SF04-120	04	15	20	120	93	-	-	-
BT40-SF05-120	05	15	20	120	93	-	-	-
BT40-SF06-120	06	21	27	120	93	36	10	M5

Shrink Fit Chuck, 4.5°, Standard
热缩刀柄, 标准型



A ↗ ≤0.003	RPM G2.5/25000	AD
----------------------	-------------------	----

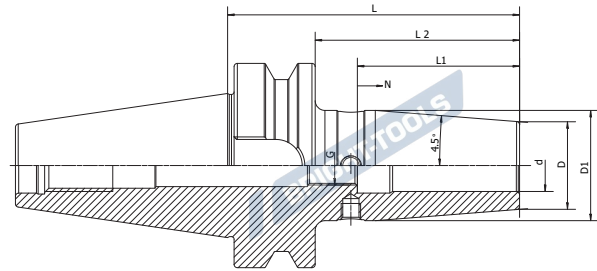

Size	d	D	D1	L	L2	L1	N	G
BT40-SF08-120	08	21	27	120	93	36	10	M6
BT40-SF10-120	10	24	32	120	93	42	10	M8x1
BT40-SF12-120	12	24	32	120	93	47	10	M10x1
BT40-SF14-120	14	27	34	120	93	47	10	M10x1
BT40-SF16-120	16	27	34	120	93	50	10	M12x1
BT40-SF18-120	18	33	42	120	93	50	10	M12x1
BT40-SF20-120	20	33	42	120	93	52	10	M16x1
BT40-SF25-120	25	44	53	120	93	58	10	M16x1
BT40-SF32-120	32	44	53	120	93	62	10	M16x1
BT40-SF03-160	03	15	25	160	133	-	-	-
BT40-SF04-160	04	15	25	160	133	-	-	-
BT40-SF05-160	05	15	25	160	133	-	-	-
BT40-SF06-160	06	21	32	160	133	36	10	M5
BT40-SF08-160	08	21	32	160	133	36	10	M6
BT40-SF10-160	10	24	34	160	133	42	10	M8x1
BT40-SF12-160	12	24	34	160	133	47	10	M10x1
BT40-SF14-160	14	27	42	160	133	47	10	M10x1
BT40-SF16-160	16	27	42	160	133	50	10	M12x1
BT40-SF18-160	18	33	51	160	133	50	10	M12x1
BT40-SF20-160	20	33	51	160	133	52	10	M16x1
BT40-SF25-160	25	44	53	160	133	58	10	M16x1
BT40-SF32-160	32	44	60	160	133	62	10	M16x1
BT40-SF06-200	06	21	32	200	173	36	10	M5
BT40-SF08-200	08	21	32	200	173	36	10	M6
BT40-SF10-200	10	24	34	200	173	42	10	M8x1
BT40-SF12-200	12	24	34	200	173	47	10	M10x1
BT40-SF14-200	14	27	42	200	173	47	10	M10x1
BT40-SF16-200	16	27	42	200	173	50	10	M12x1
BT40-SF18-200	18	33	51	200	173	50	10	M12x1
BT40-SF20-200	20	33	51	200	173	52	10	M16x1
BT40-SF25-200	25	44	53	200	173	58	10	M16x1
BT40-SF32-200	32	44	60	200	173	62	10	M16x1

Shrink Fit Chuck, 4.5°, Standard

热缩刀柄, 标准型

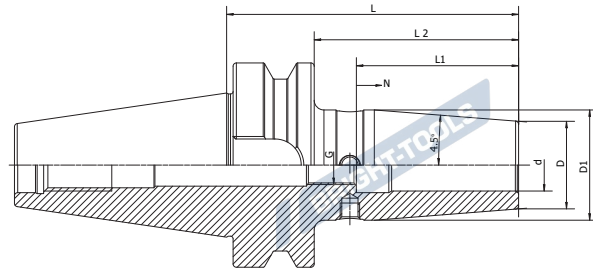
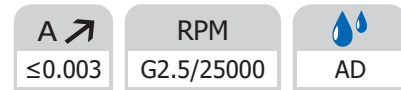

Size	d	D	D1	L	L2	L1	N	G
BT50-SF03-100	03	15	20	100	62	-	-	-
BT50-SF04-100	04	15	20	100	62	-	-	-
BT50-SF05-100	05	15	20	100	62	-	-	-
BT50-SF06-100	06	21	27	100	62	36	10	M5
BT50-SF08-100	08	21	27	100	62	36	10	M6
BT50-SF10-100	10	24	30.5	100	62	42	10	M8x1
BT50-SF12-100	12	24	30.5	100	62	47	10	M10x1
BT50-SF14-100	14	27	34	100	62	47	10	M10x1
BT50-SF16-100	16	27	34	100	62	50	10	M12x1
BT50-SF18-100	18	33	40	100	62	50	10	M12x1
BT50-SF20-100	20	33	40	100	62	52	10	M16x1
BT50-SF03-120	03	15	20	120	82	-	-	-
BT50-SF04-120	04	15	20	120	82	-	-	-
BT50-SF05-120	05	15	20	120	82	-	-	-
BT50-SF06-120	06	21	27	120	82	36	10	M5
BT50-SF08-120	08	21	27	120	82	36	10	M6
BT50-SF10-120	10	24	32	120	82	42	10	M8x1
BT50-SF12-120	12	24	32	120	82	47	10	M10x1
BT50-SF14-120	14	27	34	120	82	47	10	M10x1
BT50-SF16-120	16	27	34	120	82	50	10	M12x1
BT50-SF18-120	18	33	42	120	82	50	10	M12x1
BT50-SF20-120	20	33	42	120	82	52	10	M16x1
BT50-SF25-120	25	44	53	120	82	58	10	M16x1
BT50-SF32-120	32	44	53	120	82	62	10	M16x1

Shrink Fit Chuck, 4.5°, Standard
热缩刀柄, 标准型



A ↗ ≤0.003	RPM G2.5/25000	AD
----------------------	-------------------	----

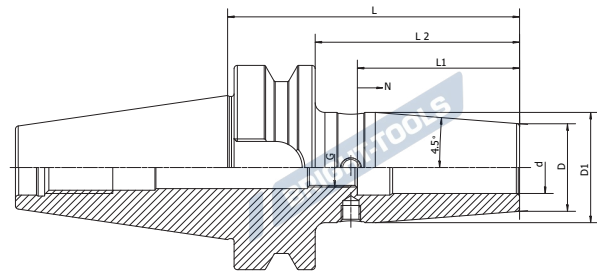

Size	d	D	D1	L	L2	L1	N	G
BT50-SF03-160	03	15	25	160	122	-	-	-
BT50-SF04-160	04	15	25	160	122	-	-	-
BT50-SF05-160	05	15	25	160	122	-	-	-
BT50-SF06-160	06	21	32	160	122	36	10	M5
BT50-SF08-160	08	21	32	160	122	36	10	M6
BT50-SF10-160	10	24	34	160	122	42	10	M8x1
BT50-SF12-160	12	24	34	160	122	47	10	M10x1
BT50-SF14-160	14	27	42	160	122	47	10	M10x1
BT50-SF16-160	16	27	42	160	122	50	10	M12x1
BT50-SF18-160	18	33	49	160	122	50	10	M12x1
BT50-SF20-160	20	33	49	160	122	52	10	M16x1
BT50-SF25-160	25	44	60	160	122	58	10	M16x1
BT50-SF32-160	32	44	60	160	122	62	10	M16x1
BT50-SF06-200	06	21	32	200	162	36	10	M5
BT50-SF08-200	08	21	32	200	162	36	10	M6
BT50-SF10-200	10	24	34	200	162	42	10	M8x1
BT50-SF12-200	12	24	34	200	162	47	10	M10x1
BT50-SF14-200	14	27	42	200	162	47	10	M10x1
BT50-SF16-200	16	27	42	200	162	50	10	M12x1
BT50-SF18-200	18	33	51	200	162	50	10	M12x1
BT50-SF20-200	20	33	51	200	162	52	10	M16x1
BT50-SF25-200	25	44	60	200	162	58	10	M16x1
BT50-SF32-200	32	44	60	200	162	62	10	M16x1
BT50-SF06-250	06	21	32	250	212	36	10	M5
BT50-SF08-250	08	21	32	250	212	36	10	M6
BT50-SF10-250	10	24	34	250	212	42	10	M8x1
BT50-SF12-250	12	24	34	250	212	47	10	M10x1
BT50-SF16-250	16	27	42	250	212	50	10	M12x1
BT50-SF18-250	18	33	51	250	212	50	10	M12x1
BT50-SF20-250	20	33	51	250	212	52	10	M16x1
BT50-SF25-250	25	44	60	250	212	58	10	M16x1
BT50-SF32-250	32	44	60	250	212	62	10	M16x1

Shrink Fit Chuck, 4.5°, Standard 热缩刀柄, 标准型



A ↗ ≤0.003	RPM G2.5/25000	AD
---------------	-------------------	----

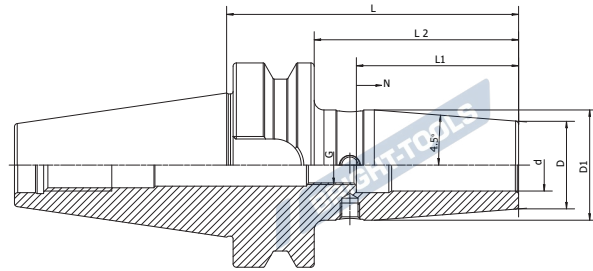

Inch

Size	d	D	D1	L	L2	L1	N	G
BT30-SF1/4"-3.15"	1/4"	0.83"	1.06"	3.15"	2.28"	1.42"	0.39"	M5
BT30-SF3/8"-3.15"	3/8"	0.95"	1.26"	3.15"	2.28"	1.65"	0.39"	M8 x 1
BT30-SF1/2"-3.15"	1/2"	0.94"	1.34"	3.15"	2.28"	1.85"	0.39"	M10 x 1
BT30-SF5/8"-3.15"	5/8"	1.06"	1.34"	3.15"	2.28"	1.97"	0.39"	M12 x 1
BT30-SF3/4"-3.15"	3/4"	1.29"	1.62"	3.15"	2.28"	2.04"	0.39"	M16 x 2.0
BT40-SF3/16"-3.54	3/16"	0.43"	0.75"	3.54"	2.67"	0.79"	-	M6 x 1.0
BT40-SF1/4"-3.54	1/4"	0.82"	1.06"	3.54"	2.67"	1.42"	0.39"	M5 x 0.8
BT40-SF3/8"-3.54	3/8"	0.94"	1.25"	3.54"	2.67"	1.65"	0.39"	-
BT40-SF1/2"-3.54	1/2"	1.10"	1.34"	3.54"	2.67"	1.85"	0.39"	M10 x 1.5
BT40-SF5/8"-3.54	5/8"	1.06"	1.34"	3.54"	2.67"	1.96"	0.39"	M12 x 1.75
BT40-SF3/4"-3.54	3/4"	1.29"	1.65"	3.54"	2.67"	2.04"	0.39"	M16 x 2.0
BT40-SF1.0"-3.54	1.0"	1.73"	2.08"	3.54"	2.67"	2.28"	0.39"	M20 x 2.0
BT40-SF1-1/4"-4.13	1-1/4"	1.81"	2.08"	4.13"	3.26"	2.28"	0.39"	M20 x 2.0
BT40-SF1/8"-6.3"	1/8"	0.36"	0.63"	6"	5.13"	0.70"	-	M6 x 1.0
BT40-SF3/16"-6.3"	3/16"	0.43"	0.70"	6"	5.13"	0.79"	-	M6 x 1.0
BT40-SF1/4"-6.3"	1/4"	0.49"	0.83"	6"	5.13"	1.42"	0.39"	M5 x 0.8
BT40-SF3/8"-6.3"	3/8"	0.61"	0.94"	6"	5.13"	1.65"	0.39"	M8 x 1.25
BT40-SF1/2"-6.3"	1/2"	0.74"	1.06"	6"	5.13"	1.85"	0.39"	M10 x 1.5
BT40-SF5/8"-6.3"	5/8"	1.06"	1.34"	6"	5.13"	1.96"	0.39"	M12 x 1.75
BT40-SF3/4"-6.3"	3/4"	1.29"	1.65"	6"	5.13"	1.65"	0.39"	M16 x 2.0
BT40-SF1"-6.3"	1"	1.73"	2.09"	6"	5.13"	2.28"	0.39"	M20 x 2.0

Shrink Fit Chuck, 4.5°, Standard
热缩刀柄, 标准型

A ↗ ≤0.003	RPM G2.5/25000	AD
---------------	-------------------	----

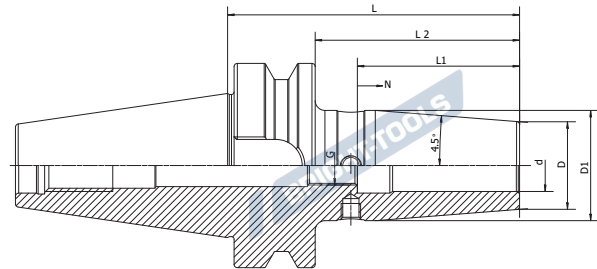

Size	d	D	D1	L	L2	L1	N	G
BBT40-SF03-80	03	15	20	80	53	-	-	-
BBT40-SF04-80	04	15	20	80	53	-	-	-
BBT40-SF05-80	05	15	20	80	53	-	-	-
BBT40-SF06-90	06	21	27	90	63	36	10	M5
BBT40-SF08-90	08	21	27	90	63	36	10	M6
BBT40-SF10-90	10	24	31	90	63	42	10	M8x1
BBT40-SF12-90	12	24	31	90	63	47	10	M10x1
BBT40-SF14-90	14	27	34	90	63	47	10	M10x1
BBT40-SF16-90	16	27	34	90	63	50	10	M12x1
BBT40-SF18-90	18	33	40	90	63	50	10	M12x1
BBT40-SF20-90	20	33	40	90	63	52	10	M16x1
BBT40-SF25-100	25	44	53	100	73	58	10	M16x1
BBT40-SF32-100	32	44	53	100	73	62	10	M16x1
BBT40-SF03-120	03	15	20	120	93	-	-	-
BBT40-SF04-120	04	15	20	120	93	-	-	-
BBT40-SF05-120	05	15	20	120	93	-	-	-
BBT40-SF06-120	06	21	27	120	93	36	10	M5
BBT40-SF08-120	08	21	27	120	93	36	10	M6
BBT40-SF10-120	10	24	32	120	93	42	10	M8x1
BBT40-SF12-120	12	24	32	120	93	47	10	M10x1
BBT40-SF14-120	14	27	34	120	93	47	10	M10x1
BBT40-SF16-120	16	27	34	120	93	50	10	M12x1
BBT40-SF18-120	18	33	42	120	93	50	10	M12x1
BBT40-SF20-120	20	33	42	120	93	52	10	M16x1
BBT40-SF25-120	25	44	53	120	93	58	10	M16x1
BBT40-SF32-120	32	44	53	120	93	62	10	M16x1



Shrink Fit Chuck, 4.5°, Standard 热缩刀柄, 标准型

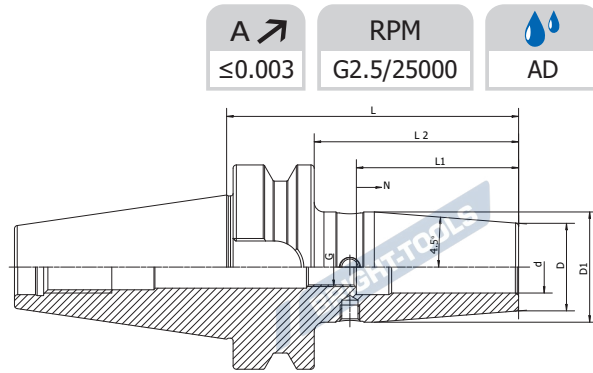

Size	d	D	D1	L	L2	L1	N	G
BBT40-SF03-160	03	15	25	160	133	-	-	-
BBT40-SF04-160	04	15	25	160	133	-	-	-
BBT40-SF05-160	05	15	25	160	133	-	-	-
BBT40-SF06-160	06	21	32	160	133	36	10	M5
BBT40-SF08-160	08	21	32	160	133	36	10	M6
BBT40-SF10-160	10	24	34	160	133	42	10	M8x1
BBT40-SF12-160	12	24	34	160	133	47	10	M10x1
BBT40-SF14-160	14	27	42	160	133	47	10	M10x1
BBT40-SF16-160	16	27	42	160	133	50	10	M12x1
BBT40-SF18-160	18	33	51	160	133	50	10	M12x1
BBT40-SF20-160	20	33	51	160	133	52	10	M16x1
BBT40-SF25-160	25	44	53	160	133	58	10	M16x1
BBT40-SF32-160	32	44	60	160	133	62	10	M16x1
BBT50-SF03-100	03	15	20	100	62	-	-	-
BBT50-SF04-100	04	15	20	100	62	-	-	-
BBT50-SF05-100	05	15	20	100	62	-	-	-
BBT50-SF06-100	06	21	27	100	62	36	10	M5
BBT50-SF08-100	08	21	27	100	62	36	10	M6
BBT50-SF10-100	10	24	30.5	100	62	42	10	M8x1
BBT50-SF12-100	12	24	30.5	100	62	47	10	M10x1
BBT50-SF14-100	14	27	34	100	62	47	10	M10x1
BBT50-SF16-100	16	27	34	100	62	50	10	M12x1
BBT50-SF18-100	18	33	40	100	62	50	10	M12x1
BBT50-SF20-100	20	33	40	100	62	52	10	M16x1
BBT50-SF25-120	25	44	53	120	82	58	10	M16x1
BBT50-SF32-120	32	44	53	120	82	62	10	M16x1

Shrink Fit Chuck, 4.5°, Standard
热缩刀柄, 标准型

A ↗ ≤0.003	RPM G2.5/25000	AD
---------------	-------------------	----

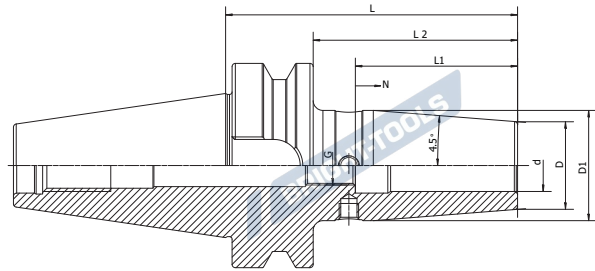

Size	d	D	D1	L	L2	L1	N	G
BBT50-SF03-120	03	15	20	120	82	-	-	-
BBT50-SF04-120	04	15	20	120	82	-	-	-
BBT50-SF05-120	05	15	20	120	82	-	-	-
BBT50-SF06-120	06	21	27	120	82	36	10	M5
BBT50-SF08-120	08	21	27	120	82	36	10	M6
BBT50-SF10-120	10	24	32	120	82	42	10	M8x1
BBT50-SF12-120	12	24	32	120	82	47	10	M10x1
BBT50-SF14-120	14	27	34	120	82	47	10	M10x1
BBT50-SF16-120	16	27	34	120	82	50	10	M12x1
BBT50-SF18-120	18	33	42	120	82	50	10	M12x1
BBT50-SF20-120	20	33	42	120	82	52	10	M16x1
BBT50-SF03-160	03	15	25	160	122	-	-	-
BBT50-SF04-160	04	15	25	160	122	-	-	-
BBT50-SF05-160	05	15	25	160	122	-	-	-
BBT50-SF06-160	06	21	32	160	122	36	10	M5
BBT50-SF08-160	08	21	32	160	122	36	10	M6
BBT50-SF10-160	10	24	34	160	122	42	10	M8x1
BBT50-SF12-160	12	24	34	160	122	47	10	M10x1
BBT50-SF14-160	14	27	42	160	122	47	10	M10x1
BBT50-SF16-160	16	27	42	160	122	50	10	M12x1
BBT50-SF18-160	18	33	49	160	122	50	10	M12x1
BBT50-SF20-160	20	33	49	160	122	52	10	M16x1
BBT50-SF25-160	25	44	60	160	122	58	10	M16x1
BBT50-SF32-160	32	44	60	160	122	62	10	M16x1



Shrink Fit Chuck, 4.5°, Standard

热缩刀柄, 标准型



A ↗ ≤0.003	RPM G2.5/25000	AD/B
---------------	-------------------	------

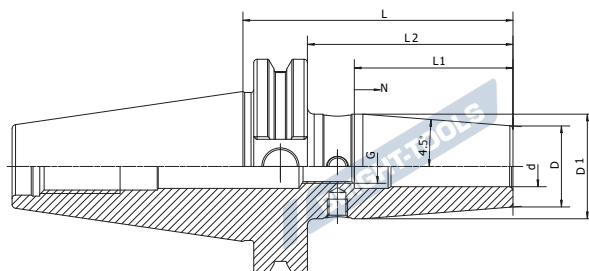

Size	d	D	D1	L	L2	L1	N	G
SK30-SF03-80	03	15	20	80	60.9	-	-	-
SK30-SF04-80	04	15	20	80	60.9	-	-	-
SK30-SF05-80	05	15	20	80	60.9	-	-	-
SK30-SF06-80	06	21	27	80	60.9	36	10	M5
SK30-SF08-80	08	21	27	80	60.9	36	10	M6
SK30-SF10-80	10	24	32	80	60.9	42	10	M8x1
SK30-SF12-80	12	24	32	80	60.9	47	10	M10x1
SK30-SF14-80	14	27	34	80	60.9	47	10	M10x1
SK30-SF16-80	16	27	34	80	60.9	50	10	M12x1
SK30-SF18-80	18	33	42	80	60.9	50	10	M12x1
SK30-SF20-80	20	33	42	80	60.9	52	10	M16x1
SK30-SF03-120	03	15	20	120	100.9	-	-	-
SK30-SF04-120	04	15	20	120	100.9	-	-	-
SK30-SF05-120	05	15	20	120	100.9	-	-	-
SK30-SF06-120	06	21	27	120	100.9	36	10	M5
SK30-SF08-120	08	21	27	120	100.9	36	10	M6
SK30-SF10-120	10	24	32	120	100.9	42	10	M8x1
SK30-SF12-120	12	24	32	120	100.9	47	10	M10x1
SK30-SF16-120	16	27	34	120	100.9	50	10	M12x1
SK40-SF03-80	03	15	20	80	60.9	-	-	-
SK40-SF04-80	04	15	20	80	60.9	-	-	-
SK40-SF05-80	05	15	20	80	60.9	-	-	-
SK40-SF06-80	06	21	27	80	60.9	36	10	M5
SK40-SF08-80	08	21	27	80	60.9	36	10	M6
SK40-SF10-80	10	24	31	80	60.9	42	10	M8x1
SK40-SF12-80	12	24	31	80	60.9	47	10	M10x1
SK40-SF14-80	14	27	34	80	60.9	47	10	M10x1
SK40-SF16-80	16	27	34	80	60.9	50	10	M12x1
SK40-SF18-80	18	33	40	80	60.9	50	10	M12x1
SK40-SF20-80	20	33	40	80	60.9	52	10	M16x1
SK40-SF25-100	25	44	50	100	80.9	58	10	M16x1
SK40-SF32-100	32	44	50	100	80.9	62	10	M16x1

Shrink Fit Chuck, 4.5°, Standard
热缩刀柄, 标准型



A ↗ ≤0.003	RPM G2.5/25000	AD/B
---------------	-------------------	------

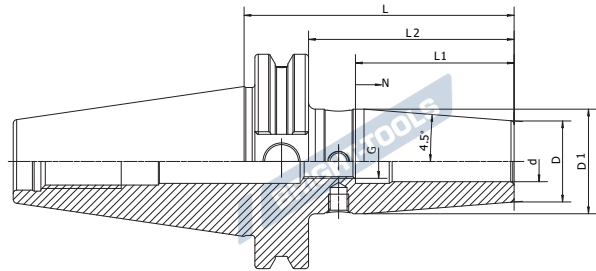

Size	d	D	D1	L	L2	L1	N	G
SK40-SF03-120	03	15	20	120	100.9	-	-	-
SK40-SF04-120	04	15	20	120	100.9	-	-	-
SK40-SF05-120	05	15	20	120	100.9	-	-	-
SK40-SF06-120	06	21	27	120	100.9	36	10	M5
SK40-SF08-120	08	21	27	120	100.9	36	10	M6
SK40-SF10-120	10	24	32	120	100.9	42	10	M8x1
SK40-SF12-120	12	24	32	120	100.9	47	10	M10x1
SK40-SF14-120	14	27	34	120	100.9	47	10	M10x1
SK40-SF16-120	16	27	34	120	100.9	50	10	M12x1
SK40-SF18-120	18	31	42	120	100.9	50	10	M12x1
SK40-SF20-120	20	31	42	120	100.9	52	10	M16x1
SK40-SF25-120	25	44	50	120	100.9	58	10	M16x1
SK40-SF03-160	03	15	20	160	140.9	-	-	-
SK40-SF04-160	04	15	20	160	140.9	-	-	-
SK40-SF05-160	05	15	20	160	140.9	-	-	-
SK40-SF06-160	06	21	32	160	140.9	36	10	M5
SK40-SF08-160	08	21	32	160	140.9	36	10	M6
SK40-SF10-160	10	24	34	160	140.9	42	10	M8x1
SK40-SF12-160	12	24	34	160	140.9	47	10	M10x1
SK40-SF14-160	14	27	42	160	140.9	47	10	M10x1
SK40-SF16-160	16	27	42	160	140.9	50	10	M12x1
SK40-SF18-160	18	33	50	160	140.9	50	10	M12x1
SK40-SF20-160	20	33	50	160	140.9	52	10	M16x1
SK40-SF25-160	25	44	50	160	140.9	58	10	M16x1
SK40-SF32-160	32	44	50	160	140.9	62	10	M16x1



Shrink Fit Chuck, 4.5°, Standard

热缩刀柄, 标准型



A ↗ ≤0.003	RPM G2.5/25000	AD/B
---------------	-------------------	------

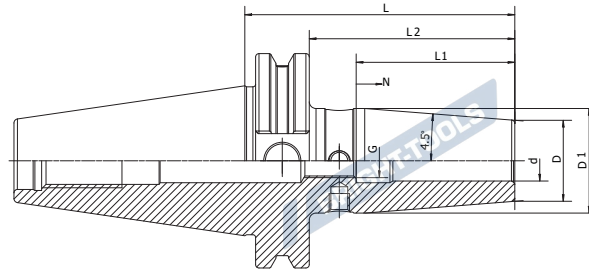

Size	d	D	D1	L	L2	L1	N	G
SK40-SF06-200	06	21	32	200	180.9	36	10	M5
SK40-SF08-200	08	21	32	200	180.9	36	10	M6
SK40-SF10-200	10	24	34	200	180.9	42	10	M8x1
SK40-SF12-200	12	24	34	200	180.9	47	10	M10x1
SK40-SF14-200	14	27	42	200	180.9	47	10	M10x1
SK40-SF16-200	16	27	42	200	180.9	50	10	M12x1
SK40-SF18-200	18	33	50	200	180.9	50	10	M12x1
SK40-SF20-200	20	33	50	200	180.9	52	10	M16x1
SK40-SF25-200	25	44	50	200	180.9	58	10	M16x1
SK40-SF32-200	32	44	50	200	180.9	62	10	M16x1
SK50-SF06-80	06	21	27	80	60.9	36	10	M5
SK50-SF08-80	08	21	27	80	60.9	36	10	M6
SK50-SF10-80	10	24	31	80	60.9	42	10	M8x1
SK50-SF12-80	12	24	31	80	60.9	47	10	M10x1
SK50-SF14-80	14	27	34	80	60.9	47	10	M10x1
SK50-SF16-80	16	27	34	80	60.9	50	10	M12x1
SK50-SF18-80	18	33	40	80	60.9	50	10	M12x1
SK50-SF20-80	20	33	39.5	80	60.9	52	10	M16x1
SK50-SF25-90	25	44	52.5	90	70.9	58	10	M16x1
SK50-SF32-90	32	44	52.5	90	70.9	62	10	M16x1

Shrink Fit Chuck, 4.5°, Standard
热缩刀柄, 标准型



A ↗ ≤0.003	RPM G2.5/25000	AD/B
---------------	-------------------	------

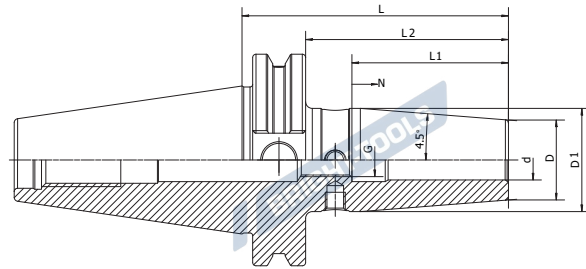

Size	d	D	D1	L	L2	L1	N	G
SK50-SF06-120	06	21	27	120	100.9	36	10	M5
SK50-SF08-120	08	21	27	120	100.9	36	10	M6
SK50-SF10-120	10	24	32	120	100.9	42	10	M8x1
SK50-SF12-120	12	24	32	120	100.9	47	10	M10x1
SK50-SF14-120	14	27	34	120	100.9	47	10	M10x1
SK50-SF16-120	16	27	34	120	100.9	50	10	M12x1
SK50-SF18-120	18	33	42	120	100.9	50	10	M12x1
SK50-SF20-120	20	33	42	120	100.9	52	10	M16x1
SK50-SF25-120	25	44	53	120	100.9	58	10	M16x1
SK50-SF32-120	32	44	53	120	100.9	62	10	M16x1
SK50-SF06-160	06	21	32	160	140.9	36	10	M5
SK50-SF08-160	08	21	32	160	140.9	36	10	M6
SK50-SF10-160	10	24	34	160	140.9	42	10	M8x1
SK50-SF12-160	12	24	34	160	140.9	47	10	M10x1
SK50-SF14-160	14	27	42	160	140.9	47	10	M10x1
SK50-SF16-160	16	27	42	160	140.9	50	10	M12x1
SK50-SF18-160	18	33	51	160	140.9	50	10	M12x1
SK50-SF20-160	20	33	51	160	140.9	52	10	M16x1
SK50-SF25-160	25	44	60	160	140.9	58	10	M16x1
SK50-SF32-160	32	44	60	160	140.9	62	10	M16x1
SK50-SF06-200	06	21	32	200	180.9	36	10	M5
SK50-SF08-200	08	21	32	200	180.9	36	10	M6
SK50-SF10-200	10	24	34	200	180.9	42	10	M8x1
SK50-SF12-200	12	24	34	200	180.9	47	10	M10x1
SK50-SF14-200	14	27	42	200	180.9	47	10	M10x1
SK50-SF16-200	16	27	42	200	180.9	50	10	M12x1
SK50-SF18-200	18	33	51	200	180.9	50	10	M12x1
SK50-SF20-200	20	33	51	200	180.9	52	10	M16x1
SK50-SF25-200	25	44	60	200	180.9	58	10	M16x1
SK50-SF32-200	32	44	60	200	180.9	62	10	M16x1

Shrink Fit Chuck, 4.5°, Standard

热缩刀柄, 标准型

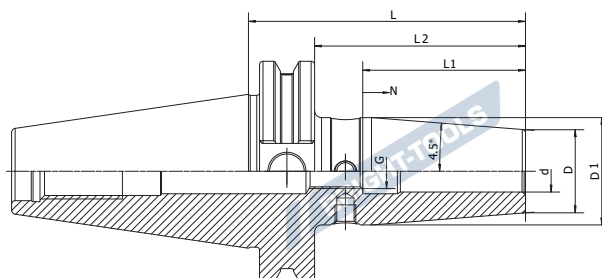
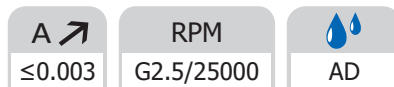

Size	d	D	D1	L	L2	L1	N	G
CAT40-SF03-80	03	15	20	80	60.9	-	-	-
CAT40-SF04-80	04	15	20	80	60.9	-	-	-
CAT40-SF05-80	05	15	20	80	60.9	-	-	-
CAT40-SF06-80	06	21	27	80	60.9	36	10	M5
CAT40-SF08-80	08	21	27	80	60.9	36	10	M6
CAT40-SF10-80	10	24	31	80	60.9	42	10	M8x1
CAT40-SF12-80	12	24	31	80	60.9	47	10	M10x1
CAT40-SF14-80	14	27	34	80	60.9	47	10	M10x1
CAT40-SF16-80	16	27	34	80	60.9	50	10	M12x1
CAT40-SF18-80	18	33	40	80	60.9	50	10	M12x1
CAT40-SF20-80	20	33	40	80	60.9	52	10	M16x1
CAT40-SF25-100	25	44	50	100	80.9	58	10	M16x1
CAT40-SF32-100	32	44	50	100	80.9	62	10	M16x1
CAT40-SF06-120	06	21	27	120	100.9	36	10	M5
CAT40-SF08-120	08	21	27	120	100.9	36	10	M6
CAT40-SF10-120	10	24	32	120	100.9	42	10	M8x1
CAT40-SF12-120	12	24	32	120	100.9	47	10	M10x1
CAT40-SF14-120	14	27	34	120	100.9	47	10	M10x1
CAT40-SF16-120	16	27	34	120	100.9	50	10	M12x1
CAT40-SF18-120	18	33	42	120	100.9	50	10	M12x1
CAT40-SF20-120	20	33	42	120	100.9	52	10	M16x1
CAT40-SF25-120	25	44	50	120	100.9	58	10	M16x1
CAT40-SF06-160	06	21	32	160	140.9	36	10	M5
CAT40-SF08-160	08	21	32	160	140.9	36	10	M6
CAT40-SF10-160	10	24	34	160	140.9	42	10	M8x1
CAT40-SF12-160	12	24	34	160	140.9	47	10	M10x1
CAT40-SF14-160	14	27	42	160	140.9	47	10	M10x1
CAT40-SF16-160	16	27	42	160	140.9	50	10	M12x1
CAT40-SF18-160	18	33	50	160	140.9	50	10	M12x1
CAT40-SF20-160	20	33	50	160	140.9	52	10	M16x1
CAT40-SF25-160	25	44	50	160	140.9	58	10	M16x1
CAT40-SF32-160	32	44	50	160	140.9	62	10	M16x1

Shrink Fit Chuck, 4.5°, Standard
热缩刀柄, 标准型



A ↗ ≤0.003	RPM G2.5/25000	AD
---------------	-------------------	----

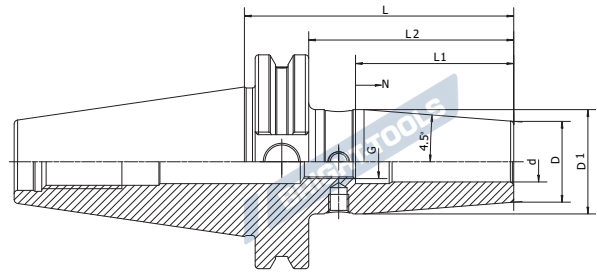

Size	d	D	D1	L	L2	L1	N	G
CAT40-SF06-200	06	21	32	200	180.9	36	10	M5
CAT40-SF08-200	08	21	32	200	180.9	36	10	M6
CAT40-SF10-200	10	24	34	200	180.9	42	10	M8x1
CAT40-SF12-200	12	24	34	200	180.9	47	10	M10x1
CAT40-SF14-200	14	27	42	200	180.9	47	10	M10x1
CAT40-SF16-200	16	27	42	200	180.9	50	10	M12x1
CAT40-SF18-200	18	33	50	200	180.9	50	10	M12x1
CAT40-SF20-200	20	33	50	200	180.9	52	10	M16x1
CAT40-SF25-200	25	44	50	200	180.9	58	10	M16x1
CAT40-SF32-200	32	44	50	200	180.9	62	10	M16x1
CAT50-SF06-80	06	21	27	80	60.9	36	10	M5
CAT50-SF08-80	08	21	27	80	60.9	36	10	M6
CAT50-SF10-80	10	24	31	80	60.9	42	10	M8x1
CAT50-SF12-80	12	24	31	80	60.9	47	10	M10x1
CAT50-SF14-80	14	27	34	80	60.9	47	10	M10x1
CAT50-SF16-80	16	27	34	80	60.9	50	10	M12x1
CAT50-SF18-80	18	33	40	80	60.9	50	10	M12x1
CAT50-SF20-80	20	33	39.5	80	60.9	52	10	M16x1
CAT50-SF25-100	25	44	52.5	100	80.9	58	10	M16x1
CAT50-SF32-100	32	44	52.5	100	80.9	62	10	M16x1
CAT50-SF06-120	06	21	27	120	100.9	36	10	M5
CAT50-SF08-120	08	21	27	120	100.9	36	10	M6
CAT50-SF10-120	10	24	32	120	100.9	42	10	M8x1
CAT50-SF12-120	12	24	32	120	100.9	47	10	M10x1
CAT50-SF14-120	14	27	34	120	100.9	47	10	M10x1
CAT50-SF16-120	16	27	34	120	100.9	50	10	M12x1
CAT50-SF18-120	18	33	42	120	100.9	50	10	M12x1
CAT50-SF20-120	20	33	42	120	100.9	52	10	M16x1
CAT50-SF25-120	25	44	53	120	100.9	58	10	M16x1
CAT50-SF32-120	32	44	53	120	100.9	62	10	M16x1

Shrink Fit Chuck, 4.5°, Standard

热缩刀柄, 标准型

A ↗ ≤0.003	RPM G2.5/25000	AD
---------------	-------------------	----

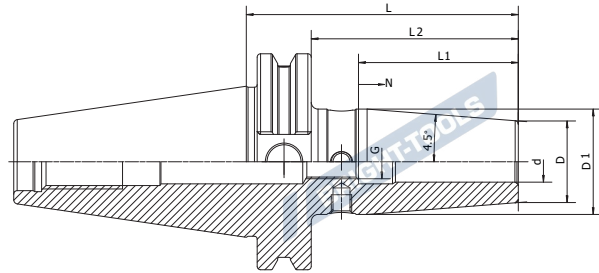

Size	d	D	D1	L	L2	L1	N	G
CAT50-SF06-160	06	21	32	160	140.9	36	10	M5
CAT50-SF08-160	08	21	32	160	140.9	36	10	M6
CAT50-SF10-160	10	24	34	160	140.9	42	10	M8x1
CAT50-SF12-160	12	24	34	160	140.9	47	10	M10x1
CAT50-SF14-160	14	27	42	160	140.9	47	10	M10x1
CAT50-SF16-160	16	27	42	160	140.9	50	10	M12x1
CAT50-SF18-160	18	33	51	160	140.9	50	10	M12x1
CAT50-SF20-160	20	33	51	160	140.9	52	10	M16x1
CAT50-SF25-160	25	44	60	160	140.9	58	10	M16x1
CAT50-SF32-160	32	44	60	160	140.9	62	10	M16x1
CAT50-SF06-200	06	21	32	200	180.9	36	10	M5
CAT50-SF08-200	08	21	32	200	180.9	36	10	M6
CAT50-SF10-200	10	24	34	200	180.9	42	10	M8x1
CAT50-SF12-200	12	24	34	200	180.9	47	10	M10x1
CAT50-SF14-200	14	27	42	200	180.9	47	10	M10x1
CAT50-SF16-200	16	27	42	200	180.9	50	10	M12x1
CAT50-SF18-200	18	33	51	200	180.9	50	10	M12x1
CAT50-SF20-200	20	33	51	200	180.9	52	10	M16x1
CAT50-SF25-200	25	44	60	200	180.9	58	10	M16x1
CAT50-SF32-200	32	44	60	200	180.9	62	10	M16x1

Shrink Fit Chuck, 4.5°, Standard
热缩刀柄, 标准型

A ↗ ≤0.003	RPM G2.5/25000	AD
----------------------	--------------------------	-----------

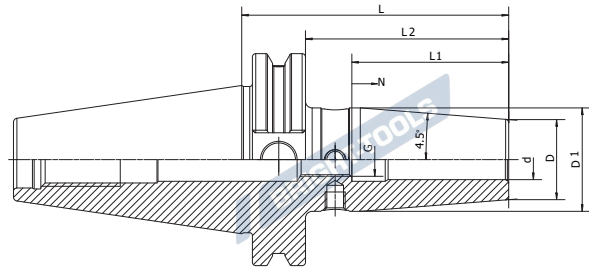

Inch

Size	d	D	D1	L	L2	L1	N	G
CAT40-SF1/8-3.15"	0.125"	0.59"	0.79"	3.15"	2.40"	-	-	-
CAT40-SF3/16-3.15"	0.187"	0.59"	0.79"	3.15"	2.40"	-	-	-
CAT40-SF1/4-3.15"	0.250"	0.83"	1.06"	3.15"	2.40"	1.42"	0.39"	M5
CAT40-SF5/16-3.15"	0.312"	0.83"	1.06"	3.15"	2.40"	1.42"	0.39"	M6
CAT40-SF3/8-3.15"	0.375"	0.94"	1.26"	3.15"	2.40"	1.65"	0.39"	M8x1
CAT40-SF1/2-3.15"	0.500"	1.06"	1.34"	3.15"	2.40"	1.85"	0.39"	M10x1
CAT40-SF5/8-3.15"	0.625"	1.06"	1.34"	3.15"	2.40"	1.97"	0.39"	M12x1
CAT40-SF3/4-3.15"	0.750"	1.30"	1.65"	3.15"	2.40"	2.05"	0.39"	M16x1
CAT40-SF1-3.94"	1.000"	1.73"	2.09"	3.94"	2.56"	2.44"	0.39"	M16x1
CAT40-SF1-1/4-3.94"	1.250"	1.73"	2.09"	3.94"	2.56"	2.44"	0.39"	M16x1
CAT40-SF1/8-4.72"	0.125"	0.59"	0.79"	4.72"	3.34"	-	-	-
CAT40-SF3/16-4.72"	0.187"	0.59"	0.79"	4.72"	3.34"	-	-	-
CAT40-SF1/4-4.72"	0.250"	0.83"	1.06"	4.72"	3.34"	1.42"	0.39"	M5
CAT40-SF5/16-4.72"	0.312"	0.83"	1.06"	4.72"	3.34"	1.42"	0.39"	M6
CAT40-SF3/8-4.72"	0.375"	0.94"	1.26"	4.72"	3.34"	1.65"	0.39"	M8x1
CAT40-SF1/2-4.72"	0.500"	1.06"	1.34"	4.72"	3.34"	1.85"	0.39"	M10x1
CAT40-SF5/8-4.72"	0.625"	1.06"	1.34"	4.72"	3.34"	1.97"	0.39"	M12x1
CAT40-SF3/4-4.72"	0.750"	1.30"	1.65"	4.72"	3.34"	2.05"	0.39"	M16x1
CAT40-SF1-4.72"	1.000"	1.73"	2.09"	4.72"	3.34"	2.44"	0.39"	M16x1
CAT40-SF1-1/4-4.72"	1.250"	1.73"	2.09"	4.72"	3.34"	2.44"	0.39"	M16x1
CAT40-SF1/8-6.30"	0.125"	0.59"	0.79"	6.30"	4.92"	-	-	-
CAT40-SF3/16-6.30"	0.187"	0.59"	0.79"	6.30"	4.92"	-	-	-
CAT40-SF1/4-6.30"	0.250"	0.83"	1.26"	6.30"	4.92"	1.42"	0.39"	M5
CAT40-SF5/16-6.30"	0.312"	0.83"	1.26"	6.30"	4.92"	1.42"	0.39"	M6
CAT40-SF3/8-6.30"	0.375"	0.94"	1.34"	6.30"	4.92"	1.65"	0.39"	M8x1
CAT40-SF1/2-6.30"	0.500"	1.06"	1.65"	6.30"	4.92"	1.85"	0.39"	M10x1
CAT40-SF5/8-6.30"	0.625"	1.06"	1.65"	6.30"	4.92"	1.97"	0.39"	M12x1
CAT40-SF3/4-6.30"	0.750"	1.30"	1.75"	6.30"	4.92"	2.05"	0.39"	M16x1
CAT40-SF1-6.30"	1.000"	1.73"	2.09"	6.30"	4.92"	2.44"	0.39"	M16x1
CAT40-SF1-1/4-6.30"	1.250"	1.73"	2.09"	6.30"	4.92"	2.44"	0.39"	M16x1

Shrink Fit Chuck, 4.5°, Standard

热缩刀柄, 标准型

A ↗ ≤0.003	RPM G2.5/25000	AD
---------------	-------------------	----

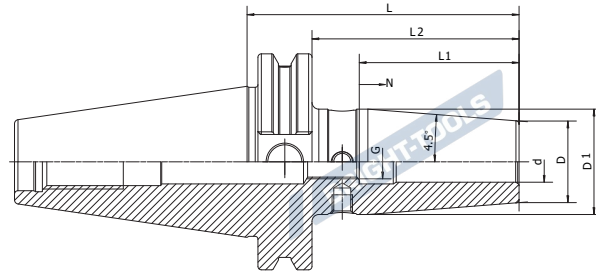

Size	d	D	D1	L	L2	L1	N	G
CAT50-SF1/4-3.15"	0.250"	0.83"	1.06"	3.15"	2.36"	1.42"	0.39"	M5
CAT50-SF3/8-3.15"	0.375"	0.94"	1.26"	3.15"	2.36"	1.65"	0.39"	M8x1
CAT50-SF1/2-3.15"	0.500"	1.06"	1.34"	3.15"	2.36"	1.85"	0.39"	M10x1
CAT50-SF5/8-3.15"	0.625"	1.06"	1.34"	3.15"	2.36"	1.97"	0.39"	M12x1
CAT50-SF3/4-3.15"	0.750"	1.30"	1.65"	3.15"	2.36"	2.05"	0.39"	M16x1
CAT50-SF1-3.94"	1.000"	1.73"	2.09"	3.94"	2.75"	2.44"	0.39"	M16x1
CAT50-SF1-1/4-3.94"	1.250"	1.73"	2.09"	3.94"	2.75"	2.44"	0.39"	M16x1
CAT50-SF1/4-4.72"	0.250"	0.83"	1.06"	4.72"	3.35"	1.42"	0.39"	M5
CAT50-SF3/8-4.72"	0.375"	0.94"	1.26"	4.72"	3.35"	1.65"	0.39"	M8x1
CAT50-SF1/2-4.72"	0.500"	1.06"	1.34"	4.72"	3.35"	1.85"	0.39"	M10x1
CAT50-SF5/8-4.72"	0.625"	1.06"	1.34"	4.72"	3.35"	1.97"	0.39"	M12x1
CAT50-SF3/4-4.72"	0.750"	1.30"	1.65"	4.72"	3.35"	2.05"	0.39"	M16x1
CAT50-SF1-4.72"	1.000"	1.73"	2.09"	4.72"	3.35"	2.44"	0.39"	M16x1
CAT50-SF1-1/4-4.72"	1.250"	1.73"	2.09"	4.72"	3.35"	2.44"	0.39"	M16x1
CAT50-SF1/4-6.30"	0.250"	0.83"	1.26"	6.30"	4.92"	1.42"	0.39"	M5
CAT50-SF3/8-6.30"	0.375"	0.94"	1.34"	6.30"	4.92"	1.65"	0.39"	M8x1
CAT50-SF1/2-6.30"	0.500"	1.06"	1.65"	6.30"	4.92"	1.85"	0.39"	M10x1
CAT50-SF5/8-6.30"	0.625"	1.06"	1.65"	6.30"	4.92"	1.97"	0.39"	M12x1
CAT50-SF3/4-6.30"	0.750"	1.30"	2.01"	6.30"	4.92"	2.05"	0.39"	M16x1
CAT50-SF1-6.30"	1.000"	1.73"	2.36"	6.30"	4.92"	2.44"	0.39"	M16x1
CAT50-SF1-1/4-6.30"	1.250"	1.73"	2.36"	6.30"	4.92"	2.44"	0.39"	M16x1

Shrink Fit Chuck, 4.5°, Standard
热缩刀柄, 标准型

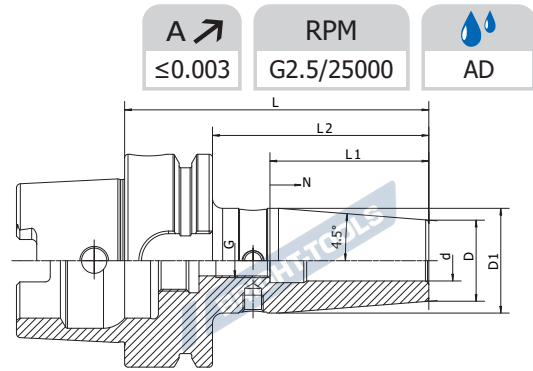

Size	d	D	D1	L	L2	L1	N	G
HSK32A-SF03-65	03	15	20	65	45	-	-	-
HSK32A-SF04-65	04	15	20	65	45	-	-	-
HSK32A-SF05-65	05	15	20	65	45	-	-	-
HSK32A-SF06-75	06	21	26	75	55	36	10	M5
HSK32A-SF08-75	08	21	26	75	55	36	10	M6
HSK32A-SF10-75	10	24	29	75	55	42	10	M8x1
HSK32A-SF12-80	12	24	29	80	60	47	5	M10x1
HSK40A-SF03-60	03	15	20	60	40	-	-	-
HSK40A-SF04-60	04	15	20	60	40	-	-	-
HSK40A-SF05-60	05	15	20	60	40	-	-	-
HSK40A-SF06-80	06	21	27	80	60	36	10	M5
HSK40A-SF08-80	08	21	27	80	60	36	10	M6
HSK40A-SF10-80	10	24	32	80	60	42	10	M8x1
HSK40A-SF12-90	12	24	32	90	70	47	10	M10x1
HSK40A-SF14-90	14	27	34	90	70	47	10	M10x1
HSK40A-SF16-90	16	27	34	90	70	50	10	M12x1
HSK50A-SF03-80	03	15	20	80	54	-	-	-
HSK50A-SF04-80	04	15	20	80	54	-	-	-
HSK50A-SF05-80	05	15	20	80	54	-	-	-
HSK50A-SF06-80	06	21	27	80	54	36	10	M5
HSK50A-SF08-80	08	21	27	80	54	36	10	M6
HSK50A-SF10-85	10	24	32	85	59	42	10	M8x1
HSK50A-SF12-90	12	24	32	90	64	47	10	M10x1
HSK50A-SF14-90	14	27	34	90	64	47	10	M10x1
HSK50A-SF16-95	16	27	34	95	69	50	10	M12x1
HSK50A-SF18-95	18	33	42	95	69	50	10	M12x1
HSK50A-SF20-100	20	33	42	100	74	52	10	M16x1



Shrink Fit Chuck, 4.5°, Standard

热缩刀柄, 标准型

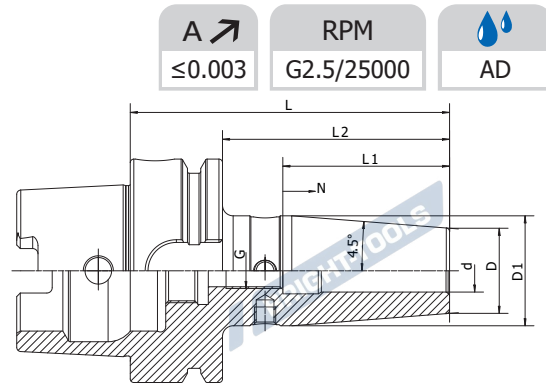

Size	d	D	D1	L	L2	L1	N	G
HSK63A-SF03-80	03	15	20	80	54	-	-	-
HSK63A-SF04-80	04	15	20	80	54	-	-	-
HSK63A-SF05-80	05	15	20	80	54	-	-	-
HSK63A-SF06-80	06	21	26.5	80	54	36	10	M5
HSK63A-SF08-80	08	21	26.5	80	54	36	10	M6
HSK63A-SF10-85	10	24	30.5	85	59	42	10	M8x1
HSK63A-SF12-90	12	24	31	90	64	47	10	M10x1
HSK63A-SF14-90	14	27	34	90	64	47	10	M10x1
HSK63A-SF16-95	16	27	34	95	69	50	10	M12x1
HSK63A-SF18-95	18	33	41	95	69	50	10	M12x1
HSK63A-SF20-100	20	33	42	100	74	52	10	M16x1
HSK63A-SF25-115	25	44	52.5	115	89	58	10	M16x1
HSK63A-SF32-120	32	44	52.5	120	94	62	10	M16x1
HSK63A-SF03-120	03	15	20	120	94	-	-	-
HSK63A-SF04-120	04	15	20	120	94	-	-	-
HSK63A-SF05-120	05	15	20	120	94	-	-	-
HSK63A-SF06-120	06	21	27	120	94	36	10	M5
HSK63A-SF08-120	08	21	27	120	94	36	10	M6
HSK63A-SF10-120	10	24	32	120	94	42	10	M8x1
HSK63A-SF12-120	12	24	32	120	94	47	10	M10x1
HSK63A-SF14-120	14	27	34	120	94	47	10	M10x1
HSK63A-SF16-120	16	27	34	120	94	50	10	M12x1
HSK63A-SF18-120	18	33	42	120	94	50	10	M12x1
HSK63A-SF20-120	20	33	42	120	94	52	10	M16x1
HSK63A-SF25-120	25	44	52.5	120	94	58	10	M16x1

Shrink Fit Chuck, 4.5°, Standard
热缩刀柄, 标准型

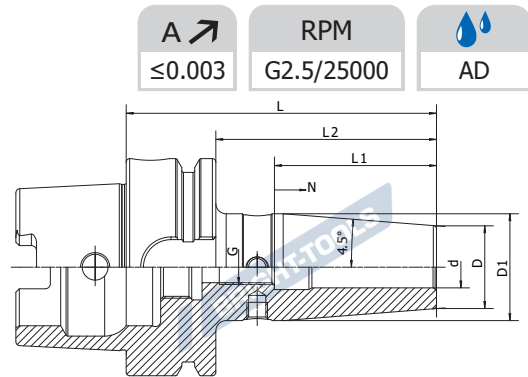

Size	d	D	D1	L	L2	L1	N	G
HSK63A-SF03-160	03	15	25	160	134	-	-	-
HSK63A-SF04-160	04	15	25	160	134	-	-	-
HSK63A-SF05-160	05	15	25	160	134	-	-	-
HSK63A-SF06-160	06	21	32	160	134	36	10	M5
HSK63A-SF08-160	08	21	32	160	134	36	10	M6
HSK63A-SF10-160	10	24	34	160	134	42	10	M8x1
HSK63A-SF12-160	12	24	34	160	134	47	10	M10x1
HSK63A-SF14-160	14	27	42	160	134	47	10	M10x1
HSK63A-SF16-160	16	27	42	160	134	50	10	M12x1
HSK63A-SF18-160	18	33	51	160	134	50	10	M12x1
HSK63A-SF20-160	20	33	51	160	134	52	10	M16x1
HSK63A-SF25-160	25	44	52.5	160	134	58	10	M16x1
HSK63A-SF32-160	32	44	52.5	160	134	62	10	M16x1
HSK63A-SF06-200	06	21	32	200	174	36	10	M5
HSK63A-SF08-200	08	21	32	200	174	36	10	M6
HSK63A-SF10-200	10	24	34	200	174	42	10	M8x1
HSK63A-SF12-200	12	24	34	200	174	47	10	M10x1
HSK63A-SF14-200	14	27	42	200	174	47	10	M10x1
HSK63A-SF16-200	16	27	42	200	174	50	10	M12x1
HSK63A-SF18-200	18	33	51	200	174	50	10	M12x1
HSK63A-SF20-200	20	33	51	200	174	52	10	M16x1
HSK63A-SF25-200	25	44	52.5	200	174	58	10	M16x1
HSK63A-SF32-200	32	44	52.5	200	174	62	10	M16x1



Shrink Fit Chuck, 4.5°, Standard

热缩刀柄, 标准型

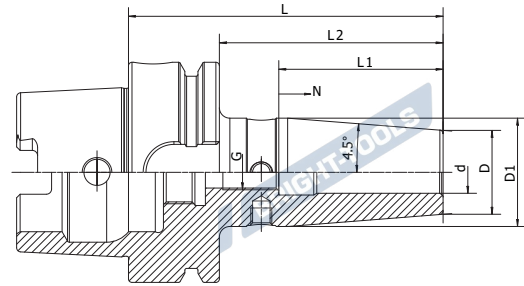
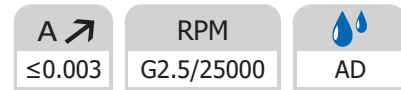

Size	d	D	D1	L	L2	L1	N	G
HSK63A-SF06-250	06	21	32	250	224	36	10	M5
HSK63A-SF08-250	08	21	32	250	224	36	10	M6
HSK63A-SF10-250	10	24	34	250	224	42	10	M8x1
HSK63A-SF12-250	12	24	34	250	224	47	10	M10x1
HSK63A-SF14-250	14	27	42	250	224	47	10	M10x1
HSK63A-SF16-250	16	27	42	250	224	50	10	M12x1
HSK63A-SF18-250	18	33	51	250	224	50	10	M12x1
HSK63A-SF20-250	20	33	51	250	224	52	10	M16x1
HSK63A-SF25-250	25	44	52.5	250	224	58	10	M16x1
HSK63A-SF32-250	32	44	52.5	250	224	62	10	M16x1
HSK63A-SF06-300	06	21	32	300	274	36	10	M5
HSK63A-SF08-300	08	21	32	300	274	36	10	M6
HSK63A-SF10-300	10	24	34	300	274	42	10	M8x1
HSK63A-SF12-300	12	24	34	300	274	47	10	M10x1
HSK63A-SF14-300	14	27	42	300	274	47	10	M10x1
HSK63A-SF16-300	16	27	42	300	274	50	10	M12x1
HSK63A-SF18-300	18	33	51	300	274	50	10	M12x1
HSK63A-SF20-300	20	33	51	300	274	52	10	M16x1
HSK63A-SF25-300	25	44	52.5	300	274	58	10	M16x1
HSK63A-SF32-300	32	44	52.5	300	274	62	10	M16x1

Shrink Fit Chuck, 4.5°, Standard 热缩刀柄, 标准型

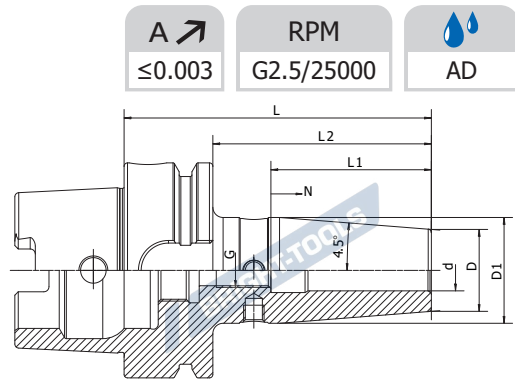

Size	d	D	D1	L	L2	L1	N	G
HSK80A-SF06-85	06	21	27	85	59	36	10	M5
HSK80A-SF08-85	08	21	27	85	59	36	10	M6
HSK80A-SF10-90	10	24	32	90	64	42	10	M8x1
HSK80A-SF12-95	12	24	32	95	69	47	10	M10x1
HSK80A-SF14-95	14	27	34	95	69	47	10	M10x1
HSK80A-SF16-100	16	27	34	100	74	50	10	M12x1
HSK80A-SF18-100	18	33	42	100	74	50	10	M12x1
HSK80A-SF20-105	20	33	42	105	79	52	10	M16x1
HSK80A-SF25-115	25	44	53	115	89	58	10	M16x1
HSK80A-SF32-120	32	44	53	120	94	62	10	M16x1
HSK100A-SF03-85	03	15	20	85	56	-	-	-
HSK100A-SF04-85	04	15	20	85	56	-	-	-
HSK100A-SF05-85	05	15	20	85	56	-	-	-
HSK100A-SF06-85	06	21	26.5	85	56	36	10	M5
HSK100A-SF08-85	08	21	26.5	85	56	36	10	M6
HSK100A-SF10-90	10	24	30.5	90	61	42	10	M8x1
HSK100A-SF12-95	12	24	31	95	66	47	10	M10x1
HSK100A-SF14-95	14	27	34	95	66	47	10	M10x1
HSK100A-SF16-100	16	27	34	100	71	50	10	M12x1
HSK100A-SF18-100	18	33	41	100	71	50	10	M12x1
HSK100A-SF20-105	20	33	42	105	76	52	10	M16x1
HSK100A-SF25-115	25	44	53	115	86	58	10	M16x1
HSK100A-SF32-120	32	44	53	120	91	62	10	M16x1



Shrink Fit Chuck, 4.5°, Standard

热缩刀柄, 标准型



A ↗	RPM	AD
≤0.003	G2.5/25000	

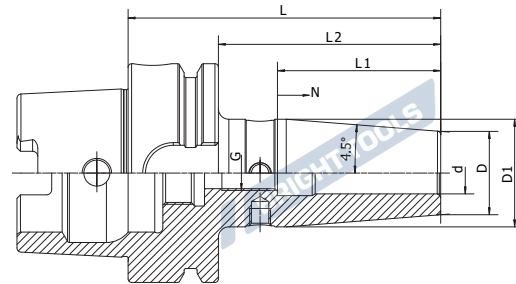

Size	d	D	D1	L	L2	L1	N	G
HSK100A-SF06-120	06	21	27	120	91	36	10	M5
HSK100A-SF08-120	08	21	27	120	91	36	10	M6
HSK100A-SF10-120	10	24	32	120	91	42	10	M8x1
HSK100A-SF12-120	12	24	32	120	91	47	10	M10x1
HSK100A-SF14-120	14	27	34	120	91	47	10	M10x1
HSK100A-SF16-120	16	27	34	120	91	50	10	M12x1
HSK100A-SF18-120	18	33	42	120	91	50	10	M12x1
HSK100A-SF20-120	20	33	42	120	91	52	10	M16x1
HSK100A-SF25-120	25	44	53	120	91	58	10	M16x1
HSK100A-SF06-160	06	21	32	160	131	36	10	M5
HSK100A-SF08-160	08	21	32	160	131	36	10	M6
HSK100A-SF10-160	10	24	34	160	131	42	10	M8x1
HSK100A-SF12-160	12	24	34	160	131	47	10	M10x1
HSK100A-SF14-160	14	27	42	160	131	47	10	M10x1
HSK100A-SF16-160	16	27	42	160	131	50	10	M12x1
HSK100A-SF18-160	18	33	50.5	160	131	50	10	M12x1
HSK100A-SF20-160	20	33	50.5	160	131	52	10	M16x1
HSK100A-SF25-160	25	44	60	160	131	58	10	M16x1
HSK100A-SF32-160	32	44	60	160	131	62	10	M16x1
HSK100A-SF06-200	06	21	32	200	171	36	10	M5
HSK100A-SF08-200	08	21	32	200	171	36	10	M6
HSK100A-SF10-200	10	24	34	200	171	42	10	M8x1
HSK100A-SF12-200	12	24	34	200	171	47	10	M10x1
HSK100A-SF14-200	14	27	42	200	171	47	10	M10x1
HSK100A-SF16-200	16	27	42	200	171	50	10	M12x1
HSK100A-SF18-200	18	33	51	200	171	50	10	M12x1
HSK100A-SF20-200	20	33	51	200	171	52	10	M16x1
HSK100A-SF25-200	25	44	60	200	171	58	10	M16x1
HSK100A-SF32-200	32	44	60	200	171	62	10	M16x1

Shrink Fit Chuck, 4.5°, Standard
热缩刀柄, 标准型



A ↗	RPM	AD
≤0.003	G2.5/25000	

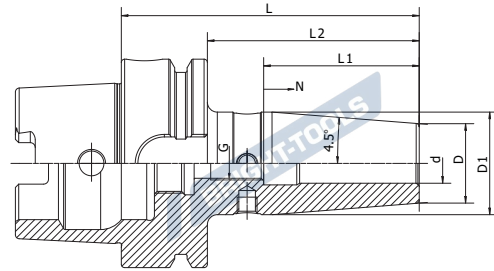

Size	d	D	D1	L	L2	L1	N	G
HSK100A-SF06-250	06	21	32	250	221	36	10	M5
HSK100A-SF08-250	08	21	32	250	221	36	10	M6
HSK100A-SF10-250	10	24	34	250	221	42	10	M8x1
HSK100A-SF12-250	12	24	34	250	221	47	10	M10x1
HSK100A-SF14-250	14	27	42	250	221	47	10	M10x1
HSK100A-SF16-250	16	27	42	250	221	50	10	M12x1
HSK100A-SF18-250	18	33	51	250	221	50	10	M12x1
HSK100A-SF20-250	20	33	51	250	221	52	10	M16x1
HSK100A-SF25-250	25	44	60	250	221	58	10	M16x1
HSK100A-SF32-250	32	44	60	250	221	62	10	M16x1
HSK100A-SF06-300	06	21	32	300	271	36	10	M5
HSK100A-SF08-300	08	21	32	300	271	36	10	M6
HSK100A-SF10-300	10	24	34	300	271	42	10	M8x1
HSK100A-SF12-300	12	24	34	300	271	47	10	M10x1
HSK100A-SF14-300	14	27	42	300	271	47	10	M10x1
HSK100A-SF16-300	16	27	42	300	271	50	10	M12x1
HSK100A-SF18-300	18	33	51	300	271	50	10	M12x1
HSK100A-SF20-300	20	33	51	300	271	52	10	M16x1
HSK100A-SF25-300	25	44	60	300	271	58	10	M16x1
HSK100A-SF32-300	32	44	60	300	271	62	10	M16x1
HSK125A-SF32-120	32	44	60	120	91	51	10	M16x1



Shrink Fit Chuck, 4.5°, Standard

热缩刀柄, 标准型



A ↗ ≤0.003	RPM G2.5/25000	AD
---------------	-------------------	----

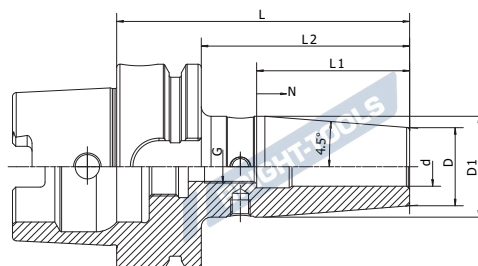

Inch

Size	d	D	D1	L	L2	L1	N	G
HSK63A-SF1/8-3.15"	0.125"	0.59"	0.79"	3.15"	2.13"	-	-	-
HSK63A-SF3/16-3.15"	0.187"	0.59"	0.79"	3.15"	2.13"	-	-	-
HSK63A-SF1/4-3.15"	0.250"	0.83"	1.06"	3.15"	2.13"	1.42"	0.39"	M5
HSK63A-SF5/16-3.15"	0.312"	0.83"	1.06"	3.15"	2.13"	1.42"	0.39"	M6
HSK63A-SF3/8-3.35"	0.375"	0.94"	1.26"	3.35"	2.32"	1.65"	0.39"	M8x1
HSK63A-SF1/2-3.54"	0.500"	1.06"	1.34"	3.54"	2.52"	1.85"	0.39"	M10x1
HSK63A-SF5/8-3.74"	0.625"	1.06"	1.34"	3.74"	2.72"	1.97"	0.39"	M12x1
HSK63A-SF3/4-3.94"	0.750"	1.30"	1.65"	3.94"	2.91"	2.05"	0.39"	M16x1
HSK63A-SF1-4.53"	1.000"	1.73"	2.07"	4.53"	3.50"	2.44"	0.39"	M16x1
HSK63A-SF1/8-4.72"	0.125"	0.59"	0.79"	4.72"	3.70"	-	-	-
HSK63A-SF3/16-4.72"	0.187"	0.59"	0.79"	4.72"	3.70"	-	-	-
HSK63A-SF1/4-4.72"	0.250"	0.83"	1.06"	4.72"	3.70"	1.42"	0.39"	M5
HSK63A-SF5/16-4.72"	0.312"	0.83"	1.06"	4.72"	3.70"	1.42"	0.39"	M6
HSK63A-SF3/8-4.72"	0.375"	0.94"	1.26"	4.72"	3.70"	1.65"	0.39"	M8x1
HSK63A-SF1/2-4.72"	0.500"	1.06"	1.34"	4.72"	3.70"	1.85"	0.39"	M10x1
HSK63A-SF5/8-4.72"	0.625"	1.06"	1.34"	4.72"	3.70"	1.97"	0.39"	M12x1
HSK63A-SF3/4-4.72"	0.750"	1.30"	1.65"	4.72"	3.70"	2.05"	0.39"	M16x1
HSK63A-SF1-4.72"	1.000"	1.73"	2.07"	4.72"	3.70"	2.44"	0.39"	M16x1
HSK63A-SF1-1/4-4.72"	1.250"	1.73"	2.07"	4.72"	3.70"	2.44"	0.39"	M16x1
HSK63A-SF1/8-6.3"	0.125"	0.59"	1.06"	6.30"	5.28"	-	-	-
HSK63A-SF3/16-6.3"	0.187"	0.59"	1.06"	6.30"	5.28"	-	-	-
HSK63A-SF1/4-6.3"	0.250"	0.83"	1.26"	6.30"	5.28"	1.42"	0.39"	M5
HSK63A-SF5/16-6.3"	0.312"	0.83"	1.26"	6.30"	5.28"	1.42"	0.39"	M6
HSK63A-SF3/8-6.3"	0.375"	0.94"	1.34"	6.30"	5.28"	1.65"	0.39"	M8x1
HSK63A-SF1/2-6.3"	0.500"	1.06"	1.65"	6.30"	5.28"	1.85"	0.39"	M10x1
HSK63A-SF5/8-6.3"	0.625"	1.06"	1.65"	6.30"	5.28"	1.97"	0.39"	M12x1
HSK63A-SF3/4-6.3"	0.750"	1.30"	2.01"	6.30"	5.28"	2.05"	0.39"	M16x1
HSK63A-SF1-6.3"	1.000"	1.73"	2.07"	6.30"	5.28"	2.44"	0.39"	M16x1
HSK63A-SF1-1/4-6.3"	1.250"	1.73"	2.07"	6.30"	5.28"	2.44"	0.39"	M16x1

Shrink Fit Chuck, 4.5°, Standard
热缩刀柄, 标准型



A ↗ ≤0.003	RPM G2.5/25000	AD
---------------	-------------------	----

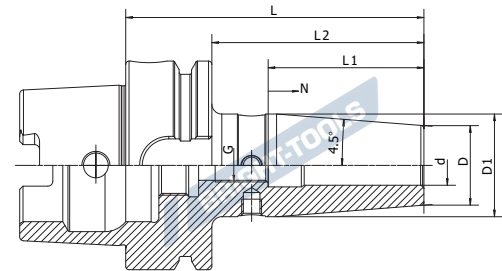

Size	d	D	D1	L	L2	L1	N	G
HSK80A-SF1/4-3.35"	0.250"	0.83"	1.06"	3.35"	2.32"	1.42"	0.39"	M5
HSK80A-SF3/8-3.54"	0.375"	0.94"	1.26"	3.54"	2.52"	1.65"	0.39"	M8x1
HSK80A-SF1/2-3.74"	0.500"	1.06"	1.34"	3.74"	2.72"	1.85"	0.39"	M10x1
HSK80A-SF5/8-3.94"	0.625"	1.06"	1.34"	3.94"	2.91"	1.97"	0.39"	M12x1
HSK80A-SF3/4-4.13"	0.750"	1.30"	1.65"	4.13"	3.11"	2.05"	0.39"	M16x1
HSK80A-SF1-4.53"	1.000"	1.73"	2.09"	4.53"	3.50"	2.44"	0.39"	M16x1
HSK80A-SF1-1/4-4.72"	1.250"	1.73"	2.09"	4.72"	3.70"	2.44"	0.39"	M16x1
HSK100A-SF1/4-3.35"	0.250"	0.83"	1.06"	3.35"	2.20"	1.42"	0.39"	M5
HSK100A-SF3/8-3.54"	0.375"	0.94"	1.26"	3.54"	2.40"	1.65"	0.39"	M8x1
HSK100A-SF1/2-3.74"	0.500"	1.06"	1.34"	3.74"	2.60"	1.85"	0.39"	M10x1
HSK100A-SF5/8-3.94"	0.625"	1.06"	1.34"	3.94"	2.80"	1.97"	0.39"	M12x1
HSK100A-SF3/4-4.13"	0.750"	1.30"	1.65"	4.13"	2.99"	2.05"	0.39"	M16x1
HSK100A-SF1-4.53"	1.000"	1.73"	2.09"	4.53"	3.39"	2.44"	0.39"	M16x1
HSK100A-SF1/4-4.72"	0.250"	0.83"	1.06"	4.72"	3.58"	1.42"	0.39"	M5
HSK100A-SF3/8-4.72"	0.375"	0.94"	1.26"	4.72"	3.58"	1.65"	0.39"	M8x1
HSK100A-SF1/2-4.72"	0.500"	1.06"	1.34"	4.72"	3.58"	1.85"	0.39"	M10x1
HSK100A-SF5/8-4.72"	0.625"	1.06"	1.34"	4.72"	3.58"	1.97"	0.39"	M12x1
HSK100A-SF3/4-4.72"	0.750"	1.30"	1.65"	4.72"	3.58"	2.05"	0.39"	M16x1
HSK100A-SF1-4.72"	1.000"	1.73"	2.09"	4.72"	3.58"	2.44"	0.39"	M16x1
HSK100A-SF1-1/4-4.72"	1.250"	1.73"	2.09"	4.72"	3.58"	2.44"	0.39"	M16x1
HSK100A-SF1/4-6.30"	0.250"	0.83"	1.26"	6.30"	5.16"	1.42"	0.39"	M5
HSK100A-SF3/8-6.30"	0.375"	0.94"	1.34"	6.30"	5.16"	1.65"	0.39"	M8x1
HSK100A-SF1/2-6.30"	0.500"	1.06"	1.65"	6.30"	5.16"	1.85"	0.39"	M10x1
HSK100A-SF5/8-6.30"	0.625"	1.06"	1.65"	6.30"	5.16"	1.97"	0.39"	M12x1
HSK100A-SF3/4-6.30"	0.750"	1.30"	2.01"	6.30"	5.16"	2.05"	0.39"	M16x1
HSK100A-SF1-6.30"	1.000"	1.73"	2.36"	6.30"	5.16"	2.44"	0.39"	M16x1
HSK100A-SF1-1/4-6.30"	1.250"	1.73"	2.36"	6.30"	5.16"	2.44"	0.39"	M16x1
HSK125A-SF3/4-4.72"	0.750"	1.30"	1.65"	4.72"	3.58"	1.61"	10	M16x1
HSK125A-SF1-4.72"	1.000"	1.73"	2.09"	4.72"	3.58"	1.85"	10	M16x1
HSK125A-SF1-1/4-4.72"	1.250"	1.73"	2.09"	4.72"	3.58"	2"	10	M16x1

Shrink Fit Chuck, 4.5°, Standard

热缩刀柄, 标准型

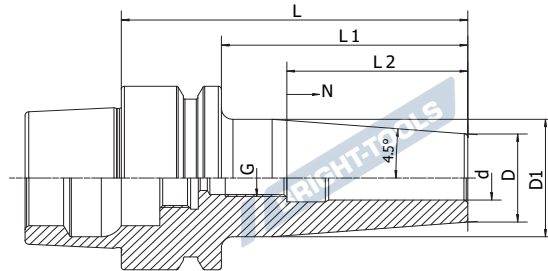
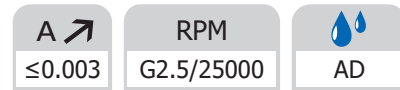

Size	d	D	D1	L	L2	L1	N	G
HSK25E-SF06-50	06	15	19	50	40	36	5	M5
HSK32E-SF03-60	03	15	20	60	40	-	-	-
HSK32E-SF04-60	04	15	20	60	40	-	-	-
HSK32E-SF05-60	05	15	20	60	40	-	-	-
HSK32E-SF06-70	06	20	26	70	50	36	10	M5
HSK32E-SF08-70	08	20	26	70	50	36	10	M6
HSK32E-SF10-70	10	24	29	70	50	42	10	M8x1
HSK32E-SF12-70	12	24	29	70	50	47	10	M10x1
HSK40E-SF03-60	03	15	20	60	40	-	-	-
HSK40E-SF04-60	04	15	20	60	40	-	-	-
HSK40E-SF05-60	05	15	20	60	40	-	-	-
HSK40E-SF06-65	06	21	27	65	45	36	10	M5
HSK40E-SF08-65	08	21	27	65	45	36	10	M6
HSK40E-SF10-65	10	24	30	65	45	42	10	M8x1
HSK40E-SF12-65	12	24	30	65	45	47	10	M10x1
HSK40E-SF03-80	03	15	20	80	60	-	-	-
HSK40E-SF04-80	04	15	20	80	60	-	-	-
HSK40E-SF05-80	05	15	20	80	60	-	-	-
HSK40E-SF06-80	06	21	27	80	60	36	10	M5
HSK40E-SF08-80	08	21	27	80	60	36	10	M6
HSK40E-SF10-80	10	24	32	80	60	42	10	M8x1
HSK40E-SF12-90	12	24	32	90	70	47	10	M10x1
HSK40E-SF16-90	16	27	34	90	70	50	10	M12x1
HSK40E-SF03-120	03	15	20	120	100	-	-	-
HSK40E-SF04-120	04	15	20	120	100	-	-	-
HSK40E-SF05-120	05	15	20	120	100	-	-	-
HSK40E-SF06-120	06	21	27	120	100	36	10	M5
HSK40E-SF08-120	08	21	27	120	100	36	10	M6
HSK40E-SF10-120	10	24	32	120	100	42	10	M8x1
HSK40E-SF12-120	12	24	32	120	100	47	10	M10x1

Shrink Fit Chuck, 4.5°, Standard
热缩刀柄, 标准型



A ↗ ≤0.003	RPM G2.5/25000	AD
---------------	-------------------	----

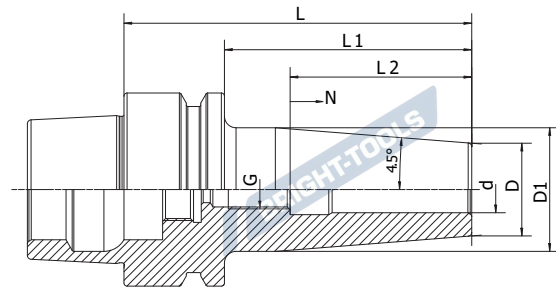

Size	d	D	D1	L	L2	L1	N	G
HSK50E-SF03-80	03	15	20	80	54	-	-	-
HSK50E-SF04-80	04	15	20	80	54	-	-	-
HSK50E-SF05-80	05	15	20	80	54	-	-	-
HSK50E-SF06-80	06	21	27	80	54	36	10	M5
HSK50E-SF08-80	08	21	27	80	54	36	10	M6
HSK50E-SF10-85	10	24	32	85	59	42	10	M8x1
HSK50E-SF12-90	12	24	32	90	64	47	10	M10x1
HSK50E-SF14-90	14	27	34	90	64	47	10	M10x1
HSK50E-SF16-95	16	27	34	95	69	50	10	M12x1
HSK50E-SF18-95	18	33	41	95	69	50	10	M12x1
HSK50E-SF20-100	20	33	41	100	74	52	10	M16x1
HSK63E-SF06-90	06	21	27	90	64	36	10	M5
HSK63E-SF08-90	08	21	27	90	64	36	10	M6
HSK63E-SF10-90	10	24	32	90	64	42	10	M8x1
HSK63E-SF12-90	12	24	32	90	64	47	10	M10x1
HSK63E-SF14-90	14	27	34	90	64	47	10	M10x1
HSK63E-SF16-95	16	27	34	95	69	50	10	M12x1
HSK63E-SF18-95	18	33	42	95	69	50	10	M12x1
HSK63E-SF20-100	20	33	42	100	74	52	10	M16x1
HSK63E-SF25-115	25	44	53	115	89	58	10	M16x1

Inch

Size	d	D	D1	L	L2	L1	N	G
HSK40E-SF1/8"-3.54"	1/8"	0.36"	0.47"	3.54"	2.76"	0.79"	-	-
HSK40E-SF3/16"-3.54"	3/16"	0.63"	0.71"	3.54"	2.76"	0.79"	-	-
HSK40E-SF1/4"-3.54"	1/4"	0.71"	1.06"	3.54"	2.76"	1.42"	0.39"	M5 x 0.8P
HSK40E-SF5/16"-3.54"	5/16"	0.83"	1.06"	3.54"	2.76"	1.42"	0.39"	M6 x 1.0P
HSK40E-SF3/8"-3.54"	3/8"	0.94"	1.26"	3.54"	2.76"	1.65"	0.39"	M8 x 1.25P

Shrink Fit Chuck, 4.5°, Standard

热缩刀柄, 标准型



A ↗ ≤0.003	RPM G2.5/25000	AD
---------------	-------------------	----

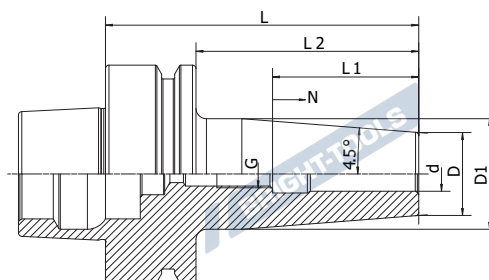

Size	d	D	D1	L	L2	L1	N	G
HSK40F-SF03-60	03	15	20	60	40	-	-	-
HSK40F-SF04-60	04	15	20	60	40	-	-	-
HSK40F-SF05-60	05	15	20	60	40	-	-	-
HSK40F-SF06-65	06	21	27	65	45	36	5	M5
HSK40F-SF08-65	08	21	27	65	45	36	5	M6
HSK40F-SF10-65	10	24	31	65	45	42	5	M8x1
HSK40F-SF12-65	12	24	31	65	45	42	5	M10x1
HSK40F-SF06-80	06	21	27	80	60	36	10	M5
HSK40F-SF08-80	08	21	27	80	60	36	10	M6
HSK40F-SF10-80	10	24	32	80	60	42	10	M8x1
HSK40F-SF12-90	12	24	32	90	70	47	10	M10x1
HSK40F-SF16-90	16	27	34	90	70	50	10	M12x1
HSK63F-SF03-90	03	15	20	90	64	-	-	-
HSK63F-SF04-90	04	15	20	90	54	-	-	-
HSK63F-SF05-90	05	15	20	90	54	-	-	-
HSK63F-SF06-90	06	21	27	90	64	36	10	M5
HSK63F-SF08-90	08	21	27	90	64	36	10	M6
HSK63F-SF10-90	10	24	32	90	64	42	10	M8x1
HSK63F-SF12-90	12	24	32	90	64	47	10	M10x1
HSK63F-SF14-95	14	27	34	95	69	47	10	M10x1
HSK63F-SF16-95	16	27	34	95	69	50	10	M12x1
HSK63F-SF18-95	18	33	42	95	69	50	10	M12x1
HSK63F-SF20-100	20	33	42	100	74	52	10	M16x1
HSK63F-SF25-115	25	36	42	115	89	58	10	M16x1

Shrink Fit Chuck, 4.5°, Standard
热缩刀柄, 标准型



A ↗ ≤0.003	RPM G2.5/25000	AD
---------------	-------------------	----

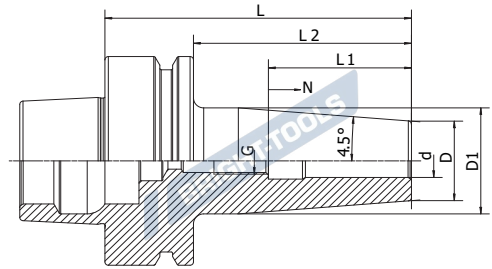

Size	d	D	D1	L	L2	L1	N	G
HSK63F-SF03-120	03	15	20	120	94	-	-	-
HSK63F-SF04-120	04	15	20	120	94	-	-	-
HSK63F-SF05-120	05	15	20	120	94	-	-	-
HSK63F-SF06-120	06	21	27	120	94	36	10	M5
HSK63F-SF08-120	08	21	27	120	94	36	10	M6
HSK63F-SF10-120	10	24	32	120	94	42	10	M8x1
HSK63F-SF12-120	12	24	32	120	94	47	10	M10x1
HSK63F-SF14-120	14	27	34	120	94	47	10	M10x1
HSK63F-SF16-120	16	27	34	120	94	50	10	M12x1
HSK63F-SF18-120	18	33	42	120	94	50	10	M12x1
HSK63F-SF20-120	20	33	42	120	94	52	10	M16x1
HSK63F-SF03-160	03	15	27	160	134	-	-	-
HSK63F-SF04-160	04	15	27	160	134	-	-	-
HSK63F-SF05-160	05	15	27	160	134	-	-	-
HSK63F-SF06-160	06	21	32	160	134	36	10	M5
HSK63F-SF08-160	08	21	32	160	134	36	10	M6
HSK63F-SF10-160	10	24	34	160	134	42	10	M8x1
HSK63F-SF12-160	12	24	34	160	134	47	10	M10x1
HSK63F-SF14-160	14	27	42	160	134	47	10	M10x1
HSK63F-SF16-160	16	27	42	160	134	50	10	M12x1
HSK63F-SF18-160	18	33	51	160	134	50	10	M12x1
HSK63F-SF20-160	20	33	51	160	134	52	10	M16x1

Inch

Size	d	D	D1	L	L2	L1	N	G
HSK63F-SF1/4"-3.54"	1/4"	0.83"	1.06"	3.54	2.52	1.42"		M5
HSK63F-SF5/16"-3.54"	5/16"	0.83"	1.06"	3.54	2.52	1.42"		M6
HSK63F-SF3/8"-3.54"	3/8"	0.94"	1.26"	3.54	2.52	1.65"		M8 x 1
HSK63F-SF1/2"-3.54"	1/2"	1.06"	1.34"	3.54	2.52	1.85"		M10 x 1
HSK63F-SF5/8"-3.74"	5/8"	1.06"	1.34"	3.74"	2.72	1.97"		M12 x 1
HSK63F-SF3/4"-3.94"	3/4"	1.30"	1.65"	3.94"	2.91	2.05"		M16 x 1
HSK63F-SF1.0"-4.53"	1"	1.73"	2.09"	4.53"	3.5	2.44"		M160 x 1

Shrink Fit Chuck, 4.5°, Coolant

热缩刀柄, 端面出水型

A ↗ ≤0.003	RPM G2.5/25000	AD
---------------	-------------------	----

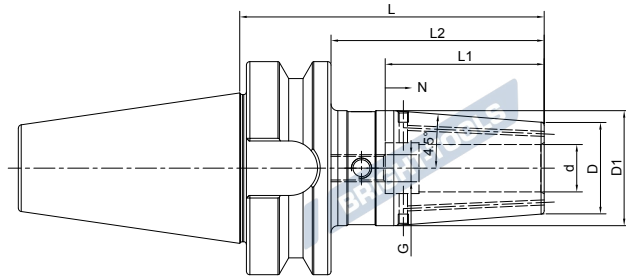

Size	d	D	D1	L	L2	L1	N	G
BT40-SF03-80K	03	15	20	80	53	-	-	-
BT40-SF04-80K	04	15	20	80	53	-	-	-
BT40-SF05-80K	05	15	20	80	53	-	-	-
BT40-SF06-90K	06	21	27	90	63	36	10	M5
BT40-SF08-90K	08	21	27	90	63	36	10	M6
BT40-SF10-90K	10	24	32	90	63	42	10	M8x1
BT40-SF12-90K	12	24	32	90	63	47	10	M10x1
BT40-SF14-90K	14	27	34	90	63	47	10	M10x1
BT40-SF16-90K	16	27	34	90	63	50	10	M12x1
BT40-SF18-90K	18	33	42	90	63	50	10	M12x1
BT40-SF20-90K	20	33	42	90	63	52	10	M16x1
BT40-SF25-100K	25	44	53	100	73	58	10	M16x1
BT40-SF32-100K	32	44	53	100	73	62	10	M16x1
BT40-SF06-120K	06	21	27	120	93	36	10	M5
BT40-SF08-120K	08	21	27	120	93	36	10	M6
BT40-SF10-120K	10	24	32	120	93	42	10	M8x1
BT40-SF12-120K	12	24	32	120	93	47	10	M10x1
BT40-SF14-120K	14	27	34	120	93	47	10	M10x1
BT40-SF16-120K	16	27	34	120	93	50	10	M12x1
BT40-SF18-120K	18	33	42	120	93	50	10	M12x1
BT40-SF20-120K	20	33	42	120	93	52	10	M16x1
BT40-SF25-120K	25	44	53	120	93	58	10	M16x1
BT40-SF32-120K	32	44	53	120	93	62	10	M16x1
BT40-SF06-160K	06	21	32	160	133	36	10	M5
BT40-SF08-160K	08	21	32	160	133	36	10	M6
BT40-SF10-160K	10	24	34	160	133	42	10	M8x1
BT40-SF12-160K	12	24	34	160	133	47	10	M10x1
BT40-SF14-160K	14	27	42	160	133	47	10	M10x1
BT40-SF16-160K	16	27	42	160	133	50	10	M12x1
BT40-SF18-160K	18	33	51	160	133	50	10	M12x1
BT40-SF20-160K	20	33	51	160	133	52	10	M16x1
BT40-SF25-160K	25	44	53	160	133	58	10	M16x1
BT40-SF32-160K	32	44	53	160	133	62	10	M16x1

Shrink Fit Chuck, 4.5°, Coolant
热缩刀柄, 端面出水型

A ↗ ≤0.003	RPM G2.5/25000	AD
---------------	-------------------	----

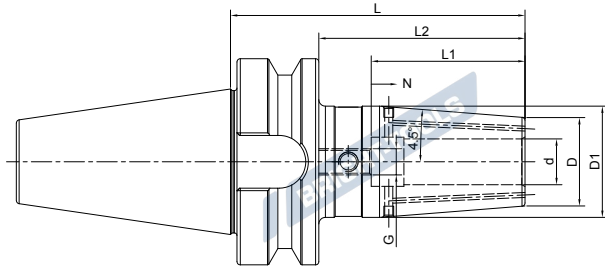

Size	d	D	D1	L	L2	L1	N	G
BT50-SF06-100K	06	21	27	100	62	36	10	M5
BT50-SF08-100K	08	21	27	100	62	36	10	M6
BT50-SF10-100K	10	24	32	100	62	42	10	M8x1
BT50-SF12-100K	12	24	32	100	62	47	10	M10x1
BT50-SF14-100K	14	27	34	100	62	47	10	M10x1
BT50-SF16-100K	16	27	34	100	62	50	10	M12x1
BT50-SF18-100K	18	33	42	100	62	50	10	M12x1
BT50-SF20-100K	20	33	42	100	62	52	10	M16x1
BT50-SF25-110K	25	44	53	110	72	58	10	M16x1
BT50-SF32-110K	32	44	53	110	72	62	10	M16x1
BT50-SF06-120K	06	21	27	120	82	36	10	M5
BT50-SF08-120K	08	21	27	120	82	36	10	M6
BT50-SF10-120K	10	24	32	120	82	42	10	M8x1
BT50-SF12-120K	12	24	32	120	82	47	10	M10x1
BT50-SF14-120K	14	27	34	120	82	47	10	M10x1
BT50-SF16-120K	16	27	34	120	82	50	10	M12x1
BT50-SF18-120K	18	33	42	120	82	50	10	M12x1
BT50-SF20-120K	20	33	42	120	82	52	10	M16x1
BT50-SF25-120K	25	44	53	120	82	58	10	M16x1
BT50-SF32-120K	32	44	53	120	82	62	10	M16x1
BT50-SF06-160K	06	21	32	160	122	36	10	M5
BT50-SF08-160K	08	21	32	160	122	36	10	M6
BT50-SF10-160K	10	24	34	160	122	42	10	M8x1
BT50-SF12-160K	12	24	34	160	122	47	10	M10x1
BT50-SF14-160K	14	27	42	160	122	47	10	M10x1
BT50-SF16-160K	16	27	42	160	122	50	10	M12x1
BT50-SF18-160K	18	33	51	160	122	50	10	M12x1
BT50-SF20-160K	20	33	51	160	122	52	10	M16x1
BT50-SF25-160K	25	44	60	160	122	58	10	M16x1
BT50-SF32-160K	32	44	60	160	122	62	10	M16x1

Shrink Fit Chuck, 4.5°, Coolant 热缩刀柄, 端面出水型

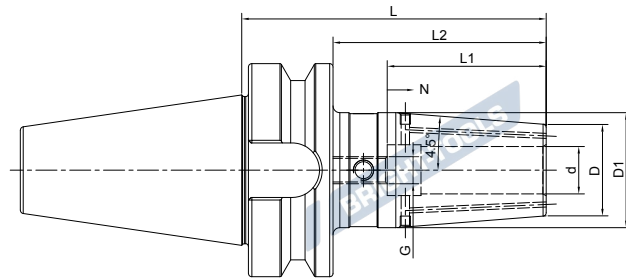
 A ↗
 ≤0.003

 RPM
 G2.5/25000

 AD

Size	d	D	D1	L	L2	L1	N	G
BBT40-SF03-80K	03	15	20	80	53	-	-	-
BBT40-SF04-80K	04	15	20	80	53	-	-	-
BBT40-SF05-80K	05	15	20	80	53	-	-	-
BBT40-SF06-90K	06	21	27	90	63	36	10	M5
BBT40-SF08-90K	08	21	27	90	63	36	10	M6
BBT40-SF10-90K	10	24	32	90	63	42	10	M8x1
BBT40-SF12-90K	12	24	32	90	63	47	10	M10x1
BBT40-SF14-90K	14	27	34	90	63	47	10	M10x1
BBT40-SF16-90K	16	27	34	90	63	50	10	M12x1
BBT40-SF18-90K	18	33	42	90	63	50	10	M12x1
BBT40-SF20-90K	20	33	42	90	63	52	10	M16x1
BBT40-SF25-100K	25	44	53	100	73	58	10	M16x1
BBT40-SF32-100K	32	44	53	100	73	62	10	M16x1
BBT40-SF06-120K	06	21	27	120	93	36	10	M5
BBT40-SF08-120K	08	21	27	120	93	36	10	M6
BBT40-SF10-120K	10	24	32	120	93	42	10	M8x1
BBT40-SF12-120K	12	24	32	120	93	47	10	M10x1
BBT40-SF14-120K	14	27	34	120	93	47	10	M10x1
BBT40-SF16-120K	16	27	34	120	93	50	10	M12x1
BBT40-SF18-120K	18	33	42	120	93	50	10	M12x1
BBT40-SF20-120K	20	33	42	120	93	52	10	M16x1
BBT40-SF25-120K	25	44	53	120	93	58	10	M16x1
BBT40-SF32-120K	32	44	53	120	93	62	10	M16x1
BBT40-SF06-160K	06	21	32	160	133	36	10	M5
BBT40-SF08-160K	08	21	32	160	133	36	10	M6
BBT40-SF10-160K	10	24	34	160	133	42	10	M8x1
BBT40-SF12-160K	12	24	34	160	133	47	10	M10x1
BBT40-SF14-160K	14	27	42	160	133	47	10	M10x1
BBT40-SF16-160K	16	27	42	160	133	50	10	M12x1
BBT40-SF18-160K	18	33	51	160	133	50	10	M12x1
BBT40-SF20-160K	20	33	51	160	133	52	10	M16x1
BBT40-SF25-160K	25	44	53	160	133	58	10	M16x1
BBT40-SF32-160K	32	44	53	160	133	62	10	M16x1

Shrink Fit Chuck, 4.5°, Coolant
热缩刀柄, 端面出水型

A ↗	RPM	
≤0.003	G2.5/25000	AD

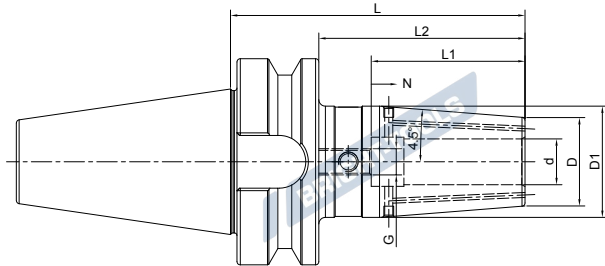

Size	d	D	D1	L	L2	L1	N	G
BBT50-SF06-100K	06	21	27	100	62	36	10	M5
BBT50-SF08-100K	08	21	27	100	62	36	10	M6
BBT50-SF10-100K	10	24	32	100	62	42	10	M8x1
BBT50-SF12-100K	12	24	32	100	62	47	10	M10x1
BBT50-SF14-100K	14	27	34	100	62	47	10	M10x1
BBT50-SF16-100K	16	27	34	100	62	50	10	M12x1
BBT50-SF18-100K	18	33	42	100	62	50	10	M12x1
BBT50-SF20-100K	20	33	42	100	62	52	10	M16x1
BBT50-SF25-110K	25	44	53	110	72	58	10	M16x1
BBT50-SF32-110K	32	44	53	110	72	62	10	M16x1
BBT50-SF06-120K	06	21	27	120	82	36	10	M5
BBT50-SF08-120K	08	21	27	120	82	36	10	M6
BBT50-SF10-120K	10	24	32	120	82	42	10	M8x1
BBT50-SF12-120K	12	24	32	120	82	47	10	M10x1
BBT50-SF14-120K	14	27	34	120	82	47	10	M10x1
BBT50-SF16-120K	16	27	34	120	82	50	10	M12x1
BBT50-SF18-120K	18	33	42	120	82	50	10	M12x1
BBT50-SF20-120K	20	33	42	120	82	52	10	M16x1
BBT50-SF25-120K	25	44	53	120	82	58	10	M16x1
BBT50-SF32-120K	32	44	53	120	82	62	10	M16x1
BBT50-SF06-160K	06	21	32	160	122	36	10	M5
BBT50-SF08-160K	08	21	32	160	122	36	10	M6
BBT50-SF10-160K	10	24	34	160	122	42	10	M8x1
BBT50-SF12-160K	12	24	34	160	122	47	10	M10x1
BBT50-SF14-160K	14	27	42	160	122	47	10	M10x1
BBT50-SF16-160K	16	27	42	160	122	50	10	M12x1
BBT50-SF18-160K	18	33	51	160	122	50	10	M12x1
BBT50-SF20-160K	20	33	51	160	122	52	10	M16x1
BBT50-SF25-160K	25	44	60	160	122	58	10	M16x1
BBT50-SF32-160K	32	44	60	160	122	62	10	M16x1

Shrink Fit Chuck, 4.5°, Coolant 热缩刀柄, 端面出水型

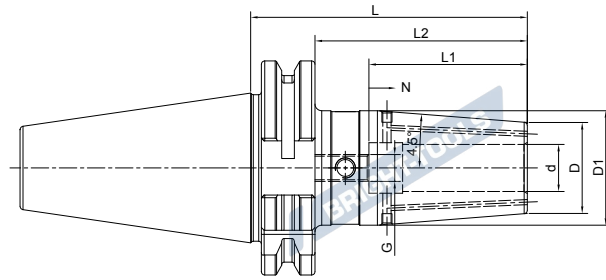
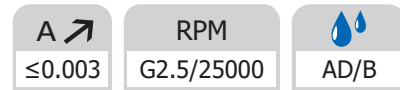

Size	d	D	D1	L	L2	L1	N	G
SK40-SF03-80K	03	15	20	80	60.9	-	-	-
SK40-SF04-80K	04	15	20	80	60.9	-	-	-
SK40-SF05-80K	05	15	20	80	60.9	-	-	-
SK40-SF06-80K	06	21	27	80	60.9	36	10	M5
SK40-SF08-80K	08	21	27	80	60.9	36	10	M6
SK40-SF10-80K	10	24	32	80	60.9	42	10	M8x1
SK40-SF12-80K	12	24	32	80	60.9	47	10	M10x1
SK40-SF14-80K	14	27	34	80	60.9	47	10	M10x1
SK40-SF16-80K	16	27	34	80	60.9	50	10	M12x1
SK40-SF18-80K	18	33	42	80	60.9	50	10	M12x1
SK40-SF20-80K	20	33	42	80	60.9	52	10	M16x1
SK40-SF25-100K	25	44	50	100	80.9	58	10	M16x1
SK40-SF32-100K	32	44	50	100	80.9	62	10	M16x1
SK40-SF06-120K	06	21	27	120	100.9	36	10	M5
SK40-SF08-120K	08	21	27	120	100.9	36	10	M6
SK40-SF10-120K	10	24	32	120	100.9	42	10	M8x1
SK40-SF12-120K	12	24	32	120	100.9	47	10	M10x1
SK40-SF14-120K	14	27	34	120	100.9	47	10	M10x1
SK40-SF16-120K	16	27	34	120	100.9	50	10	M12x1
SK40-SF18-120K	18	33	42	120	100.9	50	10	M12x1
SK40-SF20-120K	20	33	42	120	100.9	52	10	M16x1
SK40-SF06-160K	06	21	32	160	140.9	36	10	M5
SK40-SF08-160K	08	21	32	160	140.9	36	10	M6
SK40-SF10-160K	10	24	34	160	140.9	42	10	M8x1
SK40-SF12-160K	12	24	34	160	140.9	47	10	M10x1
SK40-SF14-160K	14	27	42	160	140.9	47	10	M10x1
SK40-SF16-160K	16	27	42	160	140.9	50	10	M12x1
SK40-SF18-160K	18	33	50	160	140.9	50	10	M12x1
SK40-SF20-160K	20	33	50	160	140.9	52	10	M16x1

Shrink Fit Chuck, 4.5°, Coolant
热缩刀柄，端面出水型

A ↗ ≤0.003	RPM G2.5/25000	AD
---------------	-------------------	----

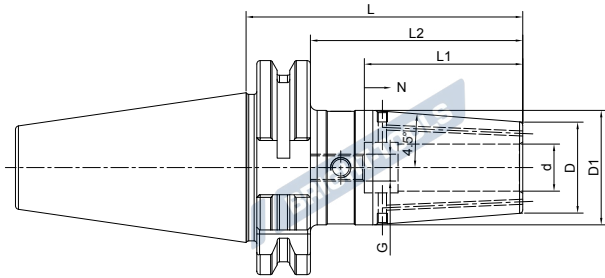

Size	d	D	D1	L	L2	L1	N	G
SK50-SF06-80K	06	21	27	80	60.9	36	10	M5
SK50-SF08-80K	08	21	27	80	60.9	36	10	M6
SK50-SF10-80K	10	24	32	80	60.9	42	10	M8x1
SK50-SF12-80K	12	24	32	80	60.9	47	10	M10x1
SK50-SF14-80K	14	27	34	80	60.9	47	10	M10x1
SK50-SF16-80K	16	27	34	80	60.9	50	10	M12x1
SK50-SF18-80K	18	33	42	80	60.9	50	10	M12x1
SK50-SF20-80K	20	33	42	80	60.9	52	10	M16x1
SK50-SF25-90K	25	44	53	90	70.9	58	10	M16x1
SK50-SF32-90K	32	44	53	90	70.9	62	10	M16x1
SK50-SF06-120K	06	21	27	120	100.9	36	10	M5
SK50-SF08-120K	08	21	27	120	100.9	36	10	M6
SK50-SF10-120K	10	24	32	120	100.9	42	10	M8x1
SK50-SF12-120K	12	24	32	120	100.9	47	10	M10x1
SK50-SF14-120K	14	27	34	120	100.9	47	10	M10x1
SK50-SF16-120K	16	27	34	120	100.9	50	10	M12x1
SK50-SF18-120K	18	33	42	120	100.9	50	10	M12x1
SK50-SF20-120K	20	33	42	120	100.9	52	10	M16x1
SK50-SF25-120K	25	44	53	120	100.9	58	10	M16x1
SK50-SF32-120K	32	44	53	120	100.9	62	10	M16x1
SK50-SF06-160K	06	21	32	160	140.9	36	10	M5
SK50-SF08-160K	08	21	32	160	140.9	36	10	M6
SK50-SF10-160K	10	24	34	160	140.9	42	10	M8x1
SK50-SF12-160K	12	24	34	160	140.9	47	10	M10x1
SK50-SF14-160K	14	27	42	160	140.9	47	10	M10x1
SK50-SF16-160K	16	27	42	160	140.9	50	10	M12x1
SK50-SF18-160K	18	33	51	160	140.9	50	10	M12x1
SK50-SF20-160K	20	33	51	160	140.9	52	10	M16x1
SK50-SF25-160K	25	44	60	160	140.9	58	10	M16x1
SK50-SF32-160K	32	44	60	160	140.9	62	10	M16x1

Shrink Fit Chuck, 4.5°, Coolant 热缩刀柄, 端面出水型

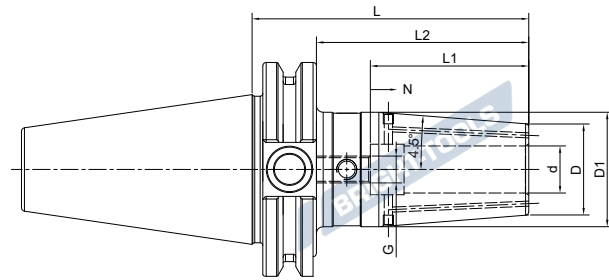
 A ↗
≤0.003

 RPM
G2.5/25000

AD

Size	d	D	D1	L	L2	L1	N	G
CAT40-SF03-80K	03	15	20	80	60.9	-	-	-
CAT40-SF04-80K	04	15	20	80	60.9	-	-	-
CAT40-SF05-80K	05	15	20	80	60.9	-	-	-
CAT40-SF06-80K	06	21	27	80	60.9	36	10	M5
CAT40-SF08-80K	08	21	27	80	60.9	36	10	M6
CAT40-SF10-80K	10	24	31	80	60.9	42	10	M8x1
CAT40-SF12-80K	12	24	31	80	60.9	47	10	M10x1
CAT40-SF14-80K	14	27	34	80	60.9	47	10	M10x1
CAT40-SF16-80K	16	27	34	80	60.9	50	10	M12x1
CAT40-SF18-80K	18	33	40	80	60.9	50	10	M12x1
CAT40-SF20-80K	20	33	40	80	60.9	52	10	M16x1
CAT40-SF25-100K	25	44	50	100	80.9	58	10	M16x1
CAT40-SF32-100K	32	44	50	100	80.9	62	10	M16x1
CAT40-SF06-120K	06	21	27	120	100.9	36	10	M5
CAT40-SF08-120K	08	21	27	120	100.9	36	10	M6
CAT40-SF10-120K	10	24	32	120	100.9	42	10	M8x1
CAT40-SF12-120K	12	24	32	120	100.9	47	10	M10x1
CAT40-SF14-120K	14	27	34	120	100.9	47	10	M10x1
CAT40-SF16-120K	16	27	34	120	100.9	50	10	M12x1
CAT40-SF18-120K	18	33	42	120	100.9	50	10	M12x1
CAT40-SF20-120K	20	33	42	120	100.9	52	10	M16x1
CAT40-SF25-120K	25	44	50	120	100.9	58	10	M16x1
CAT40-SF06-160K	06	21	32	160	140.9	36	10	M5
CAT40-SF08-160K	08	21	32	160	140.9	36	10	M6
CAT40-SF10-160K	10	24	34	160	140.9	42	10	M8x1
CAT40-SF12-160K	12	24	34	160	140.9	47	10	M10x1
CAT40-SF14-160K	14	27	42	160	140.9	47	10	M10x1
CAT40-SF16-160K	16	27	42	160	140.9	50	10	M12x1
CAT40-SF18-160K	18	33	50	160	140.9	50	10	M12x1
CAT40-SF20-160K	20	33	50	160	140.9	52	10	M16x1
CAT40-SF25-160K	25	44	50	160	140.9	58	10	M16x1
CAT40-SF32-160K	32	44	50	160	140.9	62	10	M16x1

Shrink Fit Chuck, 4.5°, Coolant
热缩刀柄, 端面出水型

A ↗ ≤0.003	RPM G2.5/25000	AD
---------------	-------------------	----

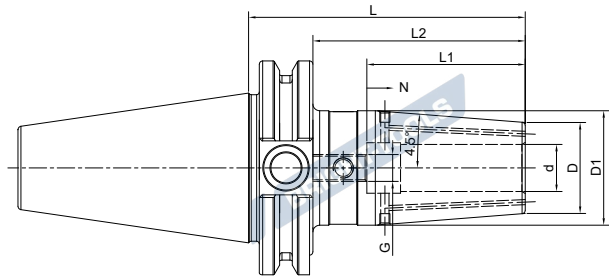

Size	d	D	D1	L	L2	L1	N	G
CAT50-SF06-80K	06	21	27	80	60.9	36	10	M5
CAT50-SF08-80K	08	21	27	80	60.9	36	10	M6
CAT50-SF10-80K	10	24	31	80	60.9	42	10	M8x1
CAT50-SF12-80K	12	24	31	80	60.9	47	10	M10x1
CAT50-SF14-80K	14	27	34	80	60.9	47	10	M10x1
CAT50-SF16-80K	16	27	34	80	60.9	50	10	M12x1
CAT50-SF18-80K	18	33	40	80	60.9	50	10	M12x1
CAT50-SF20-80K	20	33	39.5	80	60.9	52	10	M16x1
CAT50-SF25-100K	25	44	52.5	100	80.9	58	10	M16x1
CAT50-SF32-100K	32	44	52.5	100	80.9	62	10	M16x1
CAT50-SF06-120K	06	21	27	120	100.9	36	10	M5
CAT50-SF08-120K	08	21	27	120	100.9	36	10	M6
CAT50-SF10-120K	10	24	32	120	100.9	42	10	M8x1
CAT50-SF12-120K	12	24	32	120	100.9	47	10	M10x1
CAT50-SF14-120K	14	27	34	120	100.9	47	10	M10x1
CAT50-SF16-120K	16	27	34	120	100.9	50	10	M12x1
CAT50-SF18-120K	18	33	42	120	100.9	50	10	M12x1
CAT50-SF20-120K	20	33	42	120	100.9	52	10	M16x1
CAT50-SF25-120K	25	44	53	120	100.9	58	10	M16x1
CAT50-SF32-120K	32	44	53	120	100.9	62	10	M16x1

Shrink Fit Chuck, 4.5°, Coolant 热缩刀柄, 端面出水型

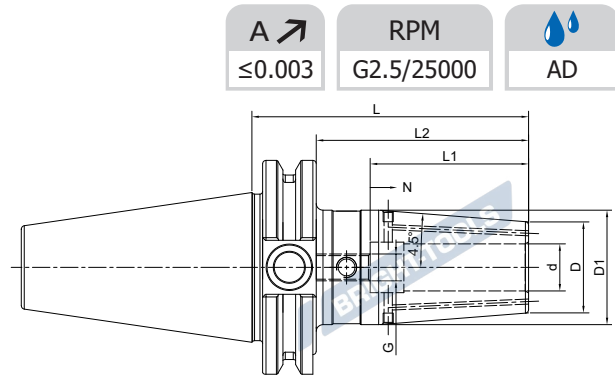

Size	d	D	D1	L	L2	L1	N	G
CAT50-SF06-160K	06	21	32	160	140.9	36	10	M5
CAT50-SF08-160K	08	21	32	160	140.9	36	10	M6
CAT50-SF10-160K	10	24	34	160	140.9	42	10	M8x1
CAT50-SF12-160K	12	24	34	160	140.9	47	10	M10x1
CAT50-SF14-160K	14	27	42	160	140.9	47	10	M10x1
CAT50-SF16-160K	16	27	42	160	140.9	50	10	M12x1
CAT50-SF18-160K	18	33	51	160	140.9	50	10	M12x1
CAT50-SF20-160K	20	33	51	160	140.9	52	10	M16x1
CAT50-SF25-160K	25	44	60	160	140.9	58	10	M16x1
CAT50-SF32-160K	32	44	60	160	140.9	62	10	M16x1
CAT50-SF06-200K	06	21	32	200	180.9	36	10	M5
CAT50-SF08-200K	08	21	32	200	180.9	36	10	M6
CAT50-SF10-200K	10	24	34	200	180.9	42	10	M8x1
CAT50-SF12-200K	12	24	34	200	180.9	47	10	M10x1
CAT50-SF14-200K	14	27	42	200	180.9	47	10	M10x1
CAT50-SF16-200K	16	27	42	200	180.9	50	10	M12x1
CAT50-SF18-200K	18	33	51	200	180.9	50	10	M12x1
CAT50-SF20-200K	20	33	51	200	180.9	52	10	M16x1
CAT50-SF25-200K	25	44	60	200	180.9	58	10	M16x1
CAT50-SF32-200K	32	44	60	200	180.9	62	10	M16x1

Shrink Fit Chuck, 4.5°, Coolant
热缩刀柄, 端面出水型



A ↗ ≤0.003	RPM G2.5/25000	AD
---------------	-------------------	----

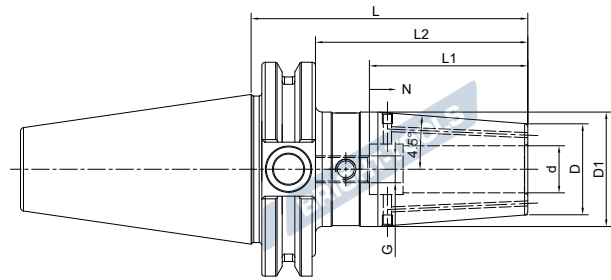

Inch

Size	d	D	D1	L	L2	L1	N	G
CAT40-SF1/8-3.15"K	0.125"	0.59"	0.79"	3.15"	2.40"	-	-	-
CAT40-SF3/16-3.15"K	0.187"	0.59"	0.79"	3.15"	2.40"	-	-	-
CAT40-SF1/4-3.15"K	0.250"	0.83"	1.06"	3.15"	2.40"	1.42"	0.39"	M5
CAT40-SF5/16-3.15"K	0.312"	0.83"	1.06"	3.15"	2.40"	1.42"	0.39"	M6
CAT40-SF3/8-3.15"K	0.375"	0.94"	1.26"	3.15"	2.40"	1.65"	0.39"	M8x1
CAT40-SF1/2-3.15"K	0.500"	1.06"	1.34"	3.15"	2.40"	1.85"	0.39"	M10x1
CAT40-SF5/8-3.15"K	0.625"	1.06"	1.34"	3.15"	2.40"	1.97"	0.39"	M12x1
CAT40-SF3/4-3.15"K	0.750"	1.30"	1.65"	3.15"	2.40"	2.05"	0.39"	M16x1
CAT40-SF1-3.94"K	1.000"	1.73"	2.09"	3.94"	2.56"	2.44"	0.39"	M16x1
CAT40-SF1-1/4-3.94"K	1.250"	1.73"	2.09"	3.94"	2.56"	2.44"	0.39"	M16x1
CAT40-SF1/8-4.72"K	0.125"	0.59"	0.79"	4.72"	3.34"	-	-	-
CAT40-SF3/16-4.72"K	0.187"	0.59"	0.79"	4.72"	3.34"	-	-	-
CAT40-SF1/4-4.72"K	0.250"	0.83"	1.06"	4.72"	3.34"	1.42"	0.39"	M5
CAT40-SF5/16-4.72"K	0.312"	0.83"	1.06"	4.72"	3.34"	1.42"	0.39"	M6
CAT40-SF3/8-4.72"K	0.375"	0.94"	1.26"	4.72"	3.34"	1.65"	0.39"	M8x1
CAT40-SF1/2-4.72"K	0.500"	1.06"	1.34"	4.72"	3.34"	1.85"	0.39"	M10x1
CAT40-SF5/8-4.72"K	0.625"	1.06"	1.34"	4.72"	3.34"	1.97"	0.39"	M12x1
CAT40-SF3/4-4.72"K	0.750"	1.30"	1.65"	4.72"	3.34"	2.05"	0.39"	M16x1
CAT40-SF1-4.72"K	1.000"	1.73"	2.09"	4.72"	3.34"	2.44"	0.39"	M16x1
CAT40-SF1-1/4-4.72"K	1.250"	1.73"	2.09"	4.72"	3.34"	2.44"	0.39"	M16x1
CAT40-SF1/8-6.30"K	0.125"	0.59"	0.79"	6.30"	4.92"	-	-	-
CAT40-SF3/16-6.30"K	0.187"	0.59"	0.79"	6.30"	4.92"	-	-	-
CAT40-SF1/4-6.30"K	0.250"	0.83"	1.26"	6.30"	4.92"	1.42"	0.39"	M5
CAT40-SF5/16-6.30"K	0.312"	0.83"	1.26"	6.30"	4.92"	1.42"	0.39"	M6
CAT40-SF3/8-6.30"K	0.375"	0.94"	1.34"	6.30"	4.92"	1.65"	0.39"	M8x1
CAT40-SF1/2-6.30"K	0.500"	1.06"	1.65"	6.30"	4.92"	1.85"	0.39"	M10x1
CAT40-SF5/8-6.30"K	0.625"	1.06"	1.65"	6.30"	4.92"	1.97"	0.39"	M12x1
CAT40-SF3/4-6.30"K	0.750"	1.30"	1.75"	6.30"	4.92"	2.05"	0.39"	M16x1
CAT40-SF1-6.30"K	1.000"	1.73"	2.09"	6.30"	4.92"	2.44"	0.39"	M16x1
CAT40-SF1-1/4-6.30"K	1.250"	1.73"	2.09"	6.30"	4.92"	2.44"	0.39"	M16x1

Shrink Fit Chuck, 4.5°, Coolant

热缩刀柄, 端面出水型

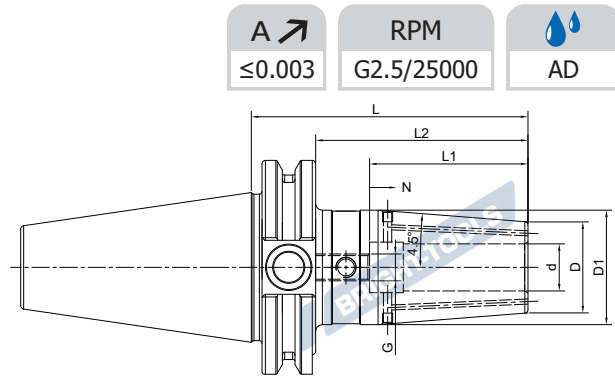
 A ↗
 ≤0.003

 RPM
 G2.5/25000



 AD

Size	d	D	D1	L	L2	L1	N	G
CAT50-SF1/4-3.15"K	0.250"	0.83"	1.06"	3.15"	2.36"	1.42"	0.39"	M5
CAT50-SF3/8-3.15"K	0.375"	0.94"	1.26"	3.15"	2.36"	1.65"	0.39"	M8x1
CAT50-SF1/2-3.15"K	0.500"	1.06"	1.34"	3.15"	2.36"	1.85"	0.39"	M10x1
CAT50-SF5/8-3.15"K	0.625"	1.06"	1.34"	3.15"	2.36"	1.97"	0.39"	M12x1
CAT50-SF3/4-3.15"K	0.750"	1.30"	1.65"	3.15"	2.36"	2.05"	0.39"	M16x1
CAT50-SF1-3.94"K	1.000"	1.73"	2.09"	3.94"	2.75"	2.44"	0.39"	M16x1
CAT50-SF1-1/4-3.94"K	1.250"	1.73"	2.09"	3.94"	2.75"	2.44"	0.39"	M16x1
CAT50-SF1/4-4.72"K	0.250"	0.83"	1.06"	4.72"	3.35"	1.42"	0.39"	M5
CAT50-SF3/8-4.72"K	0.375"	0.94"	1.26"	4.72"	3.35"	1.65"	0.39"	M8x1
CAT50-SF1/2-4.72"K	0.500"	1.06"	1.34"	4.72"	3.35"	1.85"	0.39"	M10x1
CAT50-SF5/8-4.72"K	0.625"	1.06"	1.34"	4.72"	3.35"	1.97"	0.39"	M12x1
CAT50-SF3/4-4.72"K	0.750"	1.30"	1.65"	4.72"	3.35"	2.05"	0.39"	M16x1
CAT50-SF1-4.72"K	1.000"	1.73"	2.09"	4.72"	3.35"	2.44"	0.39"	M16x1
CAT50-SF1-1/4-4.72"K	1.250"	1.73"	2.09"	4.72"	3.35"	2.44"	0.39"	M16x1
CAT50-SF1/4-6.30"K	0.250"	0.83"	1.26"	6.30"	4.92"	1.42"	0.39"	M5
CAT50-SF3/8-6.30"K	0.375"	0.94"	1.34"	6.30"	4.92"	1.65"	0.39"	M8x1
CAT50-SF1/2-6.30"K	0.500"	1.06"	1.65"	6.30"	4.92"	1.85"	0.39"	M10x1
CAT50-SF5/8-6.30"K	0.625"	1.06"	1.65"	6.30"	4.92"	1.97"	0.39"	M12x1
CAT50-SF3/4-6.30"K	0.750"	1.30"	2.01"	6.30"	4.92"	2.05"	0.39"	M16x1
CAT50-SF1-6.30"K	1.000"	1.73"	2.36"	6.30"	4.92"	2.44"	0.39"	M16x1
CAT50-SF1-1/4-6.30"K	1.250"	1.73"	2.36"	6.30"	4.92"	2.44"	0.39"	M16x1

Shrink Fit Chuck, 4.5°, Coolant 热缩刀柄, 端面出水型

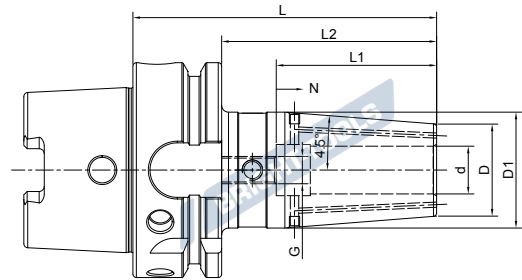

A ↗ ≤0.003	RPM G2.5/25000	AD
---------------	-------------------	----



Size	d	D	D1	L	L2	L1	N	G
HSK63A-SF03-80K	03	15	20	80	54	-	-	-
HSK63A-SF04-80K	04	15	20	80	54	-	-	-
HSK63A-SF05-80K	05	15	20	80	54	-	-	-
HSK63A-SF06-80K	06	21	26.5	80	54	36	10	M5
HSK63A-SF08-80K	08	21	26.5	80	54	36	10	M6
HSK63A-SF10-85K	10	24	30.5	85	59	42	10	M8x1
HSK63A-SF12-90K	12	24	31	90	64	47	10	M10x1
HSK63A-SF14-90K	14	27	34	90	64	47	10	M10x1
HSK63A-SF16-95K	16	27	34	95	69	50	10	M12x1
HSK63A-SF18-95K	18	33	41	95	69	50	10	M12x1
HSK63A-SF20-100K	20	33	42	100	74	52	10	M16x1
HSK63A-SF25-115K	25	44	52.5	115	89	58	10	M16x1
HSK63A-SF32-120K	32	44	52.5	120	94	62	10	M16x1
HSK63A-SF03-120K	03	15	20	120	94	-	-	-
HSK63A-SF04-120K	04	15	20	120	94	-	-	-
HSK63A-SF05-120K	05	15	20	120	94	-	-	-
HSK63A-SF06-120K	06	21	27	120	94	36	10	M5
HSK63A-SF08-120K	08	21	27	120	94	36	10	M6
HSK63A-SF10-120K	10	24	32	120	94	42	10	M8x1
HSK63A-SF12-120K	12	24	32	120	94	47	10	M10x1
HSK63A-SF14-120K	14	27	34	120	94	47	10	M10x1
HSK63A-SF16-120K	16	27	34	120	94	50	10	M12x1
HSK63A-SF18-120K	18	33	42	120	94	50	10	M12x1
HSK63A-SF20-120K	20	33	42	120	94	52	10	M16x1
HSK63A-SF25-120K	25	44	52.5	120	94	58	10	M16x1



Shrink Fit Chuck, 4.5°, Coolant

热缩刀柄, 端面出水型

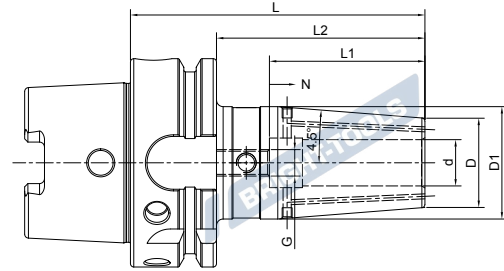
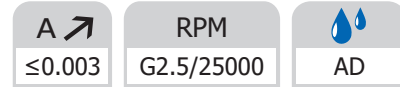

Size	d	D	D1	L	L2	L1	N	G
HSK63A-SF03-160K	03	15	25	160	134	-	-	-
HSK63A-SF04-160K	04	15	25	160	134	-	-	-
HSK63A-SF05-160K	05	15	25	160	134	-	-	-
HSK63A-SF06-160K	06	21	32	160	134	36	10	M5
HSK63A-SF08-160K	08	21	32	160	134	36	10	M6
HSK63A-SF10-160K	10	24	34	160	134	42	10	M8x1
HSK63A-SF12-160K	12	24	34	160	134	47	10	M10x1
HSK63A-SF14-160K	14	27	42	160	134	47	10	M10x1
HSK63A-SF16-160K	16	27	42	160	134	50	10	M12x1
HSK63A-SF18-160K	18	33	51	160	134	50	10	M12x1
HSK63A-SF20-160K	20	33	51	160	134	52	10	M16x1
HSK63A-SF25-160K	25	44	52.5	160	134	58	10	M16x1
HSK63A-SF32-160K	32	44	52.5	160	134	62	10	M16x1
HSK100A-SF06-85K	06	21	26.5	85	56	36	10	M5
HSK100A-SF08-85K	08	21	26.5	85	56	36	10	M6
HSK100A-SF10-90K	10	24	30.5	90	61	42	10	M8x1
HSK100A-SF12-95K	12	24	31	95	66	47	10	M10x1
HSK100A-SF14-95K	14	27	34	95	66	47	10	M10x1
HSK100A-SF16-100K	16	27	34	100	71	50	10	M12x1
HSK100A-SF18-100K	18	33	42	100	71	50	10	M12x1
HSK100A-SF20-105K	20	33	42	105	76	52	10	M16x1
HSK100A-SF25-115K	25	44	53	115	86	58	10	M16x1
HSK100A-SF32-120K	32	44	53	120	91	62	10	M16x1

Shrink Fit Chuck, 4.5°, Coolant
热缩刀柄, 端面出水型

A ↗ ≤0.003	RPM G2.5/25000	AD
---------------	-------------------	----

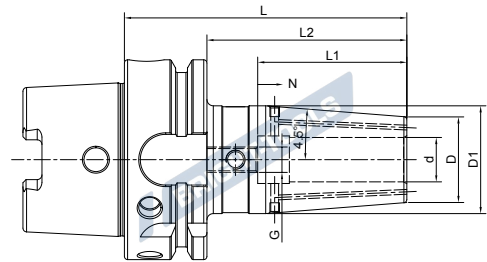

Size	d	D	D1	L	L2	L1	N	G
HSK100A-SF06-120K	06	21	27	120	91	36	10	M5
HSK100A-SF08-120K	08	21	27	120	91	36	10	M6
HSK100A-SF10-120K	10	24	32	120	91	42	10	M8x1
HSK100A-SF12-120K	12	24	32	120	91	47	10	M10x1
HSK100A-SF14-120K	14	27	34	120	91	47	10	M10x1
HSK100A-SF16-120K	16	27	34	120	91	50	10	M12x1
HSK100A-SF18-120K	18	33	42	120	91	50	10	M12x1
HSK100A-SF20-120K	20	33	42	120	91	52	10	M16x1
HSK100A-SF25-120K	25	44	53	120	91	58	10	M16x1
HSK100A-SF06-160K	06	21	32	160	131	36	10	M5
HSK100A-SF08-160K	08	21	32	160	131	36	10	M6
HSK100A-SF10-160K	10	24	34	160	131	42	10	M8x1
HSK100A-SF12-160K	12	24	34	160	131	47	10	M10x1
HSK100A-SF14-160K	14	27	42	160	131	47	10	M10x1
HSK100A-SF16-160K	16	27	42	160	131	50	10	M12x1
HSK100A-SF18-160K	18	33	51	160	131	50	10	M12x1
HSK100A-SF20-160K	20	33	51	160	131	52	10	M16x1
HSK100A-SF25-160K	25	44	60	160	131	58	10	M16x1
HSK100A-SF32-160K	32	44	60	160	131	62	10	M16x1

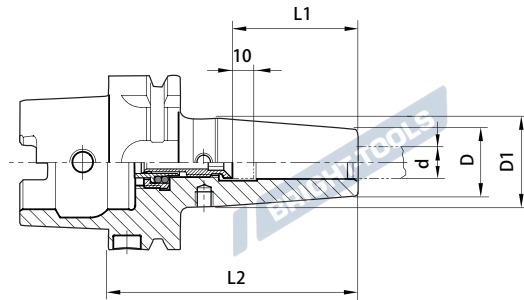
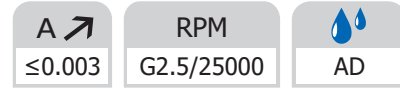
MQL1 Channel Shrink Fit Chuck
微润滑单通道热缩刀柄

Size	d	D	D1	L1	L2
HSK32A-SF06-80 MQL1	06	21	25.5	36	80
HSK32A-SF08-80 MQL1	08	21	25.5	36	80
HSK32A-SF10-85 MQL1	10	24	31.7	40	85
HSK32A-SF12-90 MQL1	12	24	32.3	45	90
HSK40A-SF06-80 MQL1	06	21	27	36	80
HSK40A-SF08-80 MQL1	08	21	27	36	80
HSK40A-SF10-80 MQL1	10	24	32	40	80
HSK40A-SF12-90 MQL1	12	24	32	45	90
HSK40A-SF14-90 MQL1	14	27	33.5	45	90
HSK40A-SF16-90 MQL1	16	27	33.5	48	90
HSK50A-SF06-80 MQL1	06	21	27	36	80
HSK50A-SF08-80 MQL1	08	21	27	36	80
HSK50A-SF10-80 MQL1	10	24	32	40	85
HSK50A-SF12-90 MQL1	12	24	32	45	90
HSK50A-SF14-90 MQL1	14	27	34	45	90
HSK50A-SF16-95 MQL1	16	27	34	48	95
HSK50A-SF18-95 MQL1	18	33	41.5	48	95
HSK50A-SF20-100 MQL1	20	33	41.5	50	100
HSK63A-SF06-80 MQL1	06	21	27	36	80
HSK63A-SF08-80 MQL1	08	21	27	36	80
HSK63A-SF10-85 MQL1	10	24	32	40	85
HSK63A-SF12-90 MQL1	12	24	32	45	90
HSK63A-SF14-90 MQL1	14	27	34	45	90
HSK63A-SF16-95 MQL1	16	27	34	48	95
HSK63A-SF18-95 MQL1	18	33	42	48	95
HSK63A-SF20-100 MQL1	20	33	42	50	100
HSK63A-SF25-115 MQL1	25	44	52.5	56	115
HSK63A-SF32-120 MQL1	32	44	52.5	60	120

MQL1 Channel Shrink Fit Chuck

微润滑单通道热缩刀柄

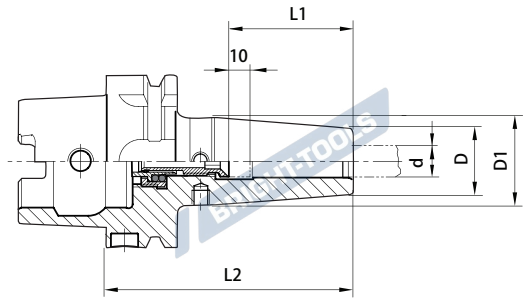
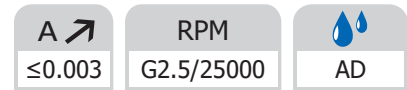

Size	d	D	D1	L1	L2
HSK63A-SF06-120 MQL1	06	21	27	36	120
HSK63A-SF08-120 MQL1	08	21	27	36	120
HSK63A-SF10-120 MQL1	10	24	32	40	120
HSK63A-SF12-120 MQL1	12	24	32	45	120
HSK63A-SF14-120 MQL1	14	27	34	45	120
HSK63A-SF16-120 MQL1	16	27	34	48	120
HSK63A-SF18-120 MQL1	18	33	42	48	120
HSK63A-SF20-120 MQL1	20	33	42	50	120
HSK63A-SF06-160 MQL1	06	21	27	36	160
HSK63A-SF08-160 MQL1	08	21	27	36	160
HSK63A-SF10-160 MQL1	10	24	32	40	160
HSK63A-SF12-160 MQL1	12	24	32	45	160
HSK63A-SF14-160 MQL1	14	27	34	45	160
HSK63A-SF16-160 MQL1	16	27	34	48	160
HSK63A-SF18-160 MQL1	18	33	42	48	160
HSK63A-SF20-160 MQL1	20	33	42	50	160
HSK63A-SF25-160 MQL1	25	44	52.5	56	160
HSK63A-SF32-160 MQL1	32	44	52.5	60	160
HSK80A-SF06-85 MQL1	06	21	27	36	85
HSK80A-SF08-85 MQL1	08	21	27	36	85
HSK80A-SF10-90 MQL1	10	24	32	40	90
HSK80A-SF12-95 MQL1	12	24	32	45	95
HSK80A-SF14-95 MQL1	14	27	34	45	95
HSK80A-SF16-100 MQL1	16	27	34	48	100
HSK80A-SF18-100 MQL1	18	33	42	48	100
HSK80A-SF20-105 MQL1	20	33	42	50	105
HSK80A-SF25-115 MQL1	25	44	53	56	115
HSK80A-SF32-120 MQL1	32	44	53	60	120



MQL1 Channel Shrink Fit Chuck
微润滑单通道热缩刀柄

A ↗ ≤0.003	RPM G2.5/25000	AD
---------------	-------------------	----

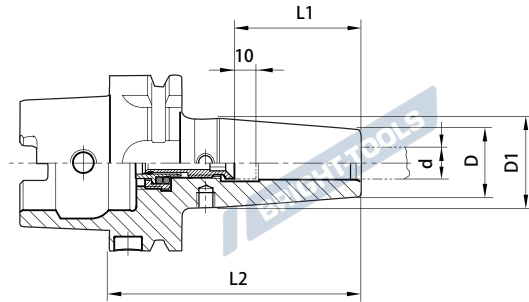

Size	d	D	D1	L1	L2
HSK100A-SF06-85 MQL1	06	21	27	36	85
HSK100A-SF08-85 MQL1	08	21	27	36	85
HSK100A-SF10-90 MQL1	10	24	32	40	90
HSK100A-SF12-95 MQL1	12	24	32	45	95
HSK100A-SF14-95 MQL1	14	27	34	45	95
HSK100A-SF16-100 MQL1	16	27	34	48	100
HSK100A-SF18-100 MQL1	18	33	42	48	100
HSK100A-SF20-105 MQL1	20	33	42	50	105
HSK100A-SF25-115 MQL1	25	44	53	56	115
HSK100A-SF32-120 MQL1	32	44	53	60	120
HSK100A-SF06-160 MQL1	06	21	27	36	160
HSK100A-SF08-160 MQL1	08	21	27	36	160
HSK100A-SF10-160 MQL1	10	24	32	40	160
HSK100A-SF12-160 MQL1	12	24	32	45	160
HSK100A-SF14-160 MQL1	14	27	34	45	160
HSK100A-SF16-160 MQL1	16	27	34	48	160
HSK100A-SF18-160 MQL1	18	33	42	48	160
HSK100A-SF20-160 MQL1	20	33	42	50	160
HSK100A-SF25-160 MQL1	25	44	53	56	160
HSK100A-SF32-160 MQL1	32	44	53	60	160

MQL2 Channel Shrink fit Chuck

微润滑双通道热缩刀柄



A ↗ ≤0.003	RPM G2.5/25000	AD
---------------	-------------------	----

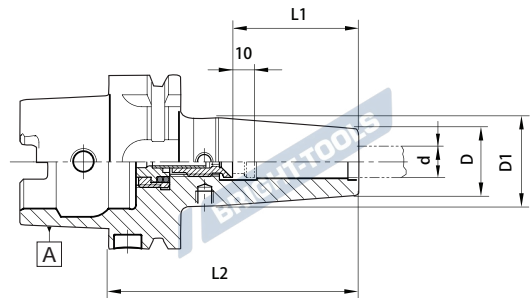

Size	d	A	D	D1	L1	L2
HSK32A-SF06-80-2.01 MQL2	06	2.01	21	25.5	36	80
HSK32A-SF06-80-4.15 MQL2	06	4.15	21	25.5	36	80
HSK32A-SF08-80-2.01 MQL2	08	2.01	21	25.5	36	80
HSK32A-SF08-80-4.15 MQL2	08	4.15	21	25.5	36	80
HSK32A-SF10-85-2.01 MQL2	10	2.01	24	31.7	40	85
HSK32A-SF10-85-4.15 MQL2	10	4.15	24	31.7	40	85
HSK32A-SF12-90-2.01 MQL2	12	2.01	24	32.3	45	90
HSK32A-SF12-90-4.15 MQL2	12	4.15	24	32.3	45	90
HSK40A-SF06-80-2.01 MQL2	06	2.01	21	27	36	80
HSK40A-SF06-80-4.15 MQL2	06	4.15	21	27	36	80
HSK40A-SF08-80-2.01 MQL2	08	2.01	21	27	36	80
HSK40A-SF08-80-4.15 MQL2	08	4.15	21	27	36	80
HSK40A-SF10-80-2.01 MQL2	10	2.01	24	32	40	80
HSK40A-SF10-80-4.15 MQL2	10	4.15	24	32	40	80
HSK40A-SF12-90-2.01 MQL2	12	2.01	24	32	45	90
HSK40A-SF12-90-4.15 MQL2	12	4.15	24	32	45	90
HSK40A-SF12-90-9.08 MQL2	12	9.08	24	32	45	90
HSK40A-SF14-90-2.01 MQL2	14	2.01	27	33.5	45	90
HSK40A-SF14-90-4.15 MQL2	14	4.15	27	33.5	45	90
HSK40A-SF14-90-9.08 MQL2	14	9.08	27	33.5	45	90
HSK40A-SF16-90-2.01 MQL2	16	2.01	27	33.5	48	90
HSK40A-SF16-90-4.15 MQL2	16	4.15	27	33.5	48	90
HSK40A-SF16-90-9.08 MQL2	16	9.08	27	33.5	48	90



MQL2 Channel Shrink Fit Chuck

微润滑双通道热缩刀柄

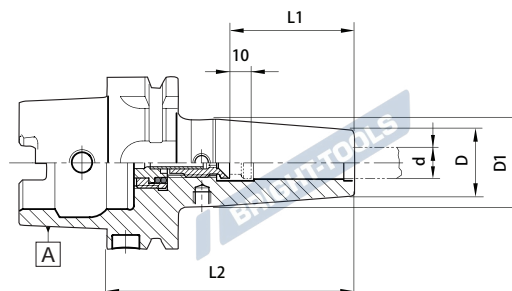
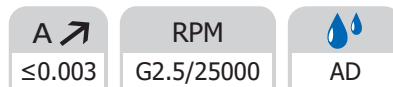

Size	d	A	D	D1	L1	L2
HSK50A-SF06-80-2.01 MQL2	06	2.01	21	27	36	80
HSK50A-SF06-80-4.15 MQL2	06	4.15	21	27	36	80
HSK50A-SF08-80-2.01 MQL2	08	2.01	21	27	36	80
HSK50A-SF08-80-4.15 MQL2	08	4.15	21	27	36	80
HSK50A-SF10-85-2.01 MQL2	10	2.01	24	32	40	85
HSK50A-SF10-85-4.15 MQL2	10	4.15	24	32	40	85
HSK50A-SF12-90-2.01 MQL2	12	2.01	24	32	45	90
HSK50A-SF12-90-4.15 MQL2	12	4.15	24	32	45	90
HSK50A-SF12-90-9.08 MQL2	12	9.08	24	32	45	90
HSK50A-SF14-90-2.01 MQL2	14	2.01	27	34	45	90
HSK50A-SF14-90-4.15 MQL2	14	4.15	27	34	45	90
HSK50A-SF14-90-9.08 MQL2	14	9.08	27	34	45	90
HSK50A-SF16-95-2.01 MQL2	16	2.01	27	34	48	95
HSK50A-SF16-95-4.15 MQL2	16	4.15	27	34	48	95
HSK50A-SF16-95-9.08 MQL2	16	9.08	27	34	48	95
HSK50A-SF18-95-2.01 MQL2	18	2.01	33	41.5	48	95
HSK50A-SF18-95-4.15 MQL2	18	4.15	33	41.5	48	95
HSK50A-SF18-95-9.08 MQL2	18	9.08	33	41.5	48	95
HSK50A-SF20-100-4.15 MQL2	20	4.15	33	41.5	50	100
HSK50A-SF20-100-9.08 MQL2	20	9.08	33	41.5	50	100
HSK50A-SF20-100-16.62 MQL2	20	16.62	33	41.5	50	100
HSK63A-SF06-80-2.01 MQL2	06	2.01	21	27	36	80
HSK63A-SF06-80-4.15 MQL2	06	4.15	21	27	36	80
HSK63A-SF08-80-2.01 MQL2	08	2.01	21	27	36	80
HSK63A-SF08-80-4.15 MQL2	08	4.15	21	27	36	80
HSK63A-SF10-85-2.01 MQL2	10	2.01	24	32	40	85
HSK63A-SF10-85-4.15 MQL2	10	4.15	24	32	40	85
HSK63A-SF12-90-2.01 MQL2	12	2.01	24	32	45	90
HSK63A-SF12-90-4.15 MQL2	12	4.15	24	32	45	90
HSK63A-SF12-90-9.08 MQL2	12	9.08	24	32	45	90
HSK63A-SF14-90-2.01 MQL2	14	2.01	27	34	45	90
HSK63A-SF14-90-4.15 MQL2	14	4.15	27	34	45	90
HSK63A-SF14-90-9.08 MQL2	14	9.08	27	34	45	90

MQL2 Channel Shrink Fit Chuck

微润滑双通道热缩刀柄

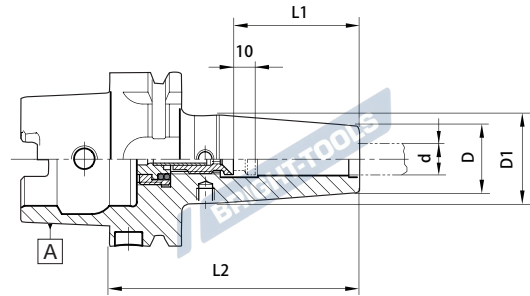
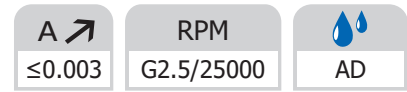

Size	d	A	D	D1	L1	L2
HSK63A-SF16-95-2.01 MQL2	16	2.01	27	34	48	95
HSK63A-SF16-95-4.15 MQL2	16	4.15	27	34	48	95
HSK63A-SF16-95-9.08 MQL2	16	9.08	27	34	48	95
HSK63A-SF18-95-2.01 MQL2	18	2.01	33	42	48	95
HSK63A-SF18-95-4.15 MQL2	18	4.15	33	42	48	95
HSK63A-SF18-95-9.08 MQL2	18	9.08	33	42	48	95
HSK63A-SF20-100-4.15 MQL2	20	4.15	33	42	50	100
HSK63A-SF20-100-9.08 MQL2	20	9.08	33	42	50	100
HSK63A-SF20-100-16.62 MQL2	20	16.62	33	42	50	100
HSK63A-SF25-115-4.15 MQL2	25	4.15	44	52.5	56	115
HSK63A-SF25-115-9.08 MQL2	25	9.08	44	52.5	56	115
HSK63A-SF25-115-16.62 MQL2	25	16.62	44	52.5	56	115
HSK63A-SF32-120-4.15 MQL2	32	4.15	44	52.5	60	120
HSK63A-SF32-120-9.08 MQL2	32	9.08	44	52.5	60	120
HSK63A-SF32-120-16.62 MQL2	32	16.62	44	52.5	60	120
HSK63A-SF06-120-2.01 MQL2	06	2.01	21	27	36	120
HSK63A-SF06-120-4.15 MQL2	06	4.15	21	27	36	120
HSK63A-SF08-120-2.01 MQL2	08	2.01	21	27	36	120
HSK63A-SF08-120-4.15 MQL2	08	4.15	21	27	36	120
HSK63A-SF10-120-2.01 MQL2	10	2.01	24	32	40	120
HSK63A-SF10-120-4.15 MQL2	10	4.15	24	32	40	120
HSK63A-SF12-120-2.01 MQL2	12	2.01	24	32	45	120
HSK63A-SF12-120-4.15 MQL2	12	4.15	24	32	45	120
HSK63A-SF12-120-9.08 MQL2	12	9.08	24	32	45	120
HSK63A-SF14-120-2.01 MQL2	14	2.01	27	34	45	120
HSK63A-SF14-120-4.15 MQL2	14	4.15	27	34	45	120
HSK63A-SF14-120-9.08 MQL2	14	9.08	27	34	45	120
HSK63A-SF16-120-2.01 MQL2	16	2.01	27	34	48	120
HSK63A-SF16-120-4.15 MQL2	16	4.15	27	34	48	120
HSK63A-SF16-120-9.08 MQL2	16	9.08	27	34	48	120
HSK63A-SF18-120-2.01 MQL2	18	2.01	33	42	48	120
HSK63A-SF18-120-4.15 MQL2	18	4.15	33	42	48	120
HSK63A-SF18-120-9.08 MQL2	18	9.08	33	42	48	120

MQL2 Channel Shrink Fit Chuck

微润滑双通道热缩刀柄

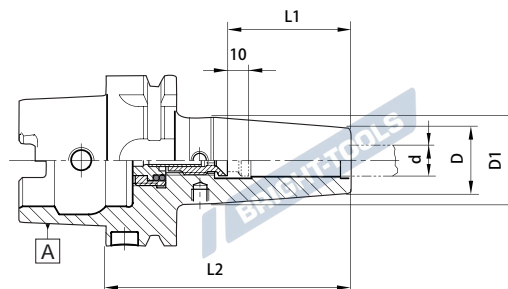
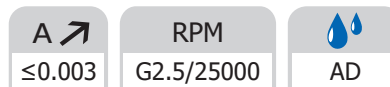

Size	d	A	D	D1	L1	L2
HSK63A-SF20-120-4.15 MQL2	20	4.15	33	42	50	120
HSK63A-SF20-120-9.08 MQL2	20	9.08	33	42	50	120
HSK63A-SF20-120-16.62 MQL2	20	16.62	33	42	50	120
HSK63A-SF06-160-2.01 MQL2	06	2.01	21	27	36	160
HSK63A-SF06-160-4.15 MQL2	06	4.15	21	27	36	160
HSK63A-SF08-160-2.01 MQL2	08	2.01	21	27	36	160
HSK63A-SF08-160-4.15 MQL2	08	4.15	21	27	36	160
HSK63A-SF10-160-2.01 MQL2	10	2.01	24	32	40	160
HSK63A-SF10-160-4.15 MQL2	10	4.15	24	32	40	160
HSK63A-SF12-160-2.01 MQL2	12	2.01	24	32	45	160
HSK63A-SF12-160-4.15 MQL2	12	4.15	24	32	45	160
HSK63A-SF12-160-9.08 MQL2	12	9.08	24	32	45	160
HSK63A-SF14-160-2.01 MQL2	14	2.01	27	34	45	160
HSK63A-SF14-160-4.15 MQL2	14	4.15	27	34	45	160
HSK63A-SF14-160-9.08 MQL2	14	9.08	27	34	45	160
HSK63A-SF16-160-2.01 MQL2	16	2.01	27	34	48	160
HSK63A-SF16-160-4.15 MQL2	16	4.15	27	34	48	160
HSK63A-SF16-160-9.08 MQL2	16	9.08	27	34	48	160
HSK63A-SF18-160-2.01 MQL2	18	2.01	33	42	48	160
HSK63A-SF18-160-4.15 MQL2	18	4.15	33	42	48	160
HSK63A-SF18-160-9.08 MQL2	18	9.08	33	42	48	160
HSK63A-SF20-160-4.15 MQL2	20	4.15	33	42	50	160
HSK63A-SF20-160-9.08 MQL2	20	9.08	33	42	50	160
HSK63A-SF20-160-16.62 MQL2	20	16.62	33	42	50	160
HSK63A-SF25-160-4.15 MQL2	25	4.15	44	52.5	56	160
HSK63A-SF25-160-9.08 MQL2	25	9.08	44	52.5	56	160
HSK63A-SF25-160-16.62 MQL2	25	16.62	44	52.5	56	160
HSK63A-SF32-160-4.15 MQL2	32	4.15	44	52.5	60	160
HSK63A-SF32-160-9.08 MQL2	32	9.08	44	52.5	60	160
HSK63A-SF32-160-16.62 MQL2	32	16.62	44	52.5	60	160

MQL2 Channel Shrink Fit Chuck

微润滑双通道热缩刀柄



A ↗	RPM	
≤0.003	G2.5/25000	AD

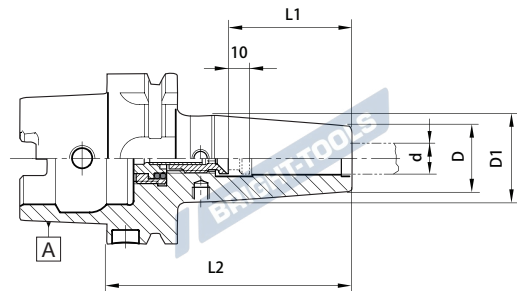

Size	d	A	D	D1	L1	L2
HSK80A-SF06-85-2.01 MQL2	06	2.01	21	27	36	85
HSK80A-SF06-85-4.15 MQL2	06	4.15	21	27	36	85
HSK80A-SF08-85-2.01 MQL2	08	2.01	21	27	36	85
HSK80A-SF08-85-4.15 MQL2	08	4.15	21	27	36	85
HSK80A-SF10-90-2.01 MQL2	10	2.01	24	32	40	90
HSK80A-SF10-90-4.15 MQL2	10	4.15	24	32	40	90
HSK80A-SF12-95-2.01 MQL2	12	2.01	24	32	45	95
HSK80A-SF12-95-4.15 MQL2	12	4.15	24	32	45	95
HSK80A-SF12-95-9.08 MQL2	12	9.08	24	32	45	95
HSK80A-SF14-95-2.01 MQL2	14	2.01	27	34	45	95
HSK80A-SF14-95-4.15 MQL2	14	4.15	27	34	45	95
HSK80A-SF14-95-9.08 MQL2	14	9.08	27	34	45	95
HSK80A-SF16-100-2.01 MQL2	16	2.01	27	34	48	100
HSK80A-SF16-100-4.15 MQL2	16	4.15	27	34	48	100
HSK80A-SF16-100-9.08 MQL2	16	9.08	27	34	48	100
HSK80A-SF18-100-2.01 MQL2	18	2.01	33	42	48	100
HSK80A-SF18-100-4.15 MQL2	18	4.15	33	42	48	100
HSK80A-SF18-100-9.08 MQL2	18	9.08	33	42	48	100
HSK80A-SF20-105-4.15 MQL2	20	4.15	33	42	50	105
HSK80A-SF20-105-9.08 MQL2	20	9.08	33	42	50	105
HSK80A-SF20-105-16.62 MQL2	20	16.62	33	42	50	105
HSK80A-SF25-115-4.15 MQL2	25	4.15	44	53	56	115
HSK80A-SF25-115-9.08 MQL2	25	9.08	44	53	56	115
HSK80A-SF25-115-16.62 MQL2	25	16.62	44	53	56	115
HSK80A-SF32-120-4.15 MQL2	32	4.15	44	53	60	120
HSK80A-SF32-120-9.08 MQL2	32	9.08	44	53	60	120
HSK80A-SF32-120-16.62 MQL2	32	16.62	44	53	60	120



MQL2 Channel Shrink Fit Chuck
微润滑双通道热缩刀柄

A ↗ ≤0.003	RPM G2.5/25000	AD
----------------------	--------------------------	-----------

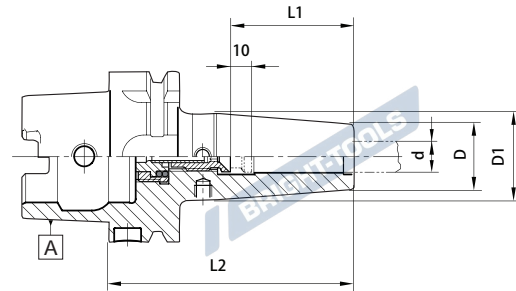

Size	d	A	D	D1	L1	L2
HSK100A-SF06-85-2.01 MQL2	06	2.01	21	27	36	85
HSK100A-SF06-85-4.15 MQL2	06	4.15	21	27	36	85
HSK100A-SF08-85-2.01 MQL2	08	2.01	21	27	36	85
HSK100A-SF08-85-4.15 MQL2	08	4.15	21	27	36	85
HSK100A-SF10-90-2.01 MQL2	10	2.01	24	32	40	90
HSK100A-SF10-90-4.15 MQL2	10	4.15	24	32	40	90
HSK100A-SF12-95-2.01 MQL2	12	2.01	24	32	45	95
HSK100A-SF12-95-4.15 MQL2	12	4.15	24	32	45	95
HSK100A-SF12-95-9.08 MQL2	12	9.08	24	32	45	95
HSK100A-SF14-95-2.01 MQL2	14	2.01	27	34	45	95
HSK100A-SF14-95-4.15 MQL2	14	4.15	27	34	45	95
HSK100A-SF14-95-9.08 MQL2	14	9.08	27	34	45	95
HSK100A-SF16-100-2.01 MQL2	16	2.01	27	34	48	100
HSK100A-SF16-100-4.15 MQL2	16	4.15	27	34	48	100
HSK100A-SF16-100-9.08 MQL2	16	9.08	27	34	48	100
HSK100A-SF18-100-2.01 MQL2	18	2.01	33	42	48	100
HSK100A-SF18-100-4.15 MQL2	18	4.15	33	42	48	100
HSK100A-SF18-100-9.08 MQL2	18	9.08	33	42	48	100
HSK100A-SF20-105-4.15 MQL2	20	4.15	33	42	50	105
HSK100A-SF20-105-9.08 MQL2	20	9.08	33	42	50	105
HSK100A-SF20-105-16.62 MQL2	20	16.62	33	42	50	105
HSK100A-SF25-115-4.15 MQL2	25	4.15	44	53	56	115
HSK100A-SF25-115-9.08 MQL2	25	9.08	44	53	56	115
HSK100A-SF25-115-16.62 MQL2	25	16.62	44	53	56	115
HSK100A-SF32-120-4.15 MQL2	32	4.15	44	53	60	120
HSK100A-SF32-120-9.08 MQL2	32	9.08	44	53	60	120
HSK100A-SF32-120-16.62 MQL2	32	16.62	44	53	60	120
HSK100A-SF06-160-2.01 MQL2	06	2.01	21	27	36	160
HSK100A-SF06-160-4.15 MQL2	06	4.15	21	27	36	160
HSK100A-SF08-160-2.01 MQL2	08	2.01	21	27	36	160
HSK100A-SF08-160-4.15 MQL2	08	4.15	21	27	36	160
HSK100A-SF10-160-2.01 MQL2	10	2.01	24	32	40	160
HSK100A-SF10-160-4.15 MQL2	10	4.15	24	32	40	160

MQL2 Channel Shrink Fit Chuck

微润滑双通道热缩刀柄



A ↗ ≤0.003	RPM G2.5/25000	AD
---------------	-------------------	----

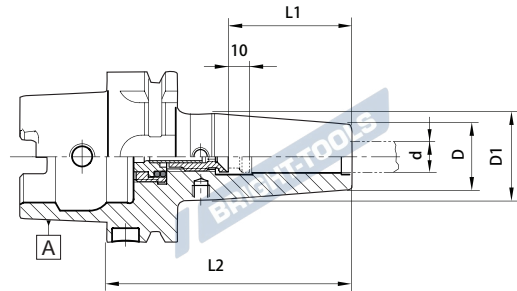

Size	d	A	D	D1	L1	L2
HSK100A-SF12-160-2.01 MQL2	12	2.01	24	32	45	160
HSK100A-SF12-160-4.15 MQL2	12	4.15	24	32	45	160
HSK100A-SF12-160-9.08 MQL2	12	9.08	24	32	45	160
HSK100A-SF14-160-2.01 MQL2	14	2.01	27	34	45	160
HSK100A-SF14-160-4.15 MQL2	14	4.15	27	34	45	160
HSK100A-SF14-160-9.08 MQL2	14	9.08	27	34	45	160
HSK100A-SF16-160-2.01 MQL2	16	2.01	27	34	48	160
HSK100A-SF16-160-4.15 MQL2	16	4.15	27	34	48	160
HSK100A-SF16-160-9.08 MQL2	16	9.08	27	34	48	160
HSK100A-SF18-160-2.01 MQL2	18	2.01	33	42	48	160
HSK100A-SF18-160-4.15 MQL2	18	4.15	33	42	48	160
HSK100A-SF18-160-9.08 MQL2	18	9.08	33	42	48	160
HSK100A-SF20-160-4.15 MQL2	20	4.15	33	42	50	160
HSK100A-SF20-160-9.08 MQL2	20	9.08	33	42	50	160
HSK100A-SF20-160-16.62 MQL2	20	16.62	33	42	50	160
HSK100A-SF25-160-4.15 MQL2	25	4.15	44	53	56	160
HSK100A-SF25-160-9.08 MQL2	25	9.08	44	53	56	160
HSK100A-SF25-160-16.62 MQL2	25	16.62	44	53	56	160
HSK100A-SF32-160-4.15 MQL2	32	4.15	44	53	60	160
HSK100A-SF32-160-9.08 MQL2	32	9.08	44	53	60	160
HSK100A-SF32-160-16.62 MQL2	32	16.62	44	53	60	160



Shrink Fit Chuck, Slim, 3°

热缩刀柄 3 度, 细长型

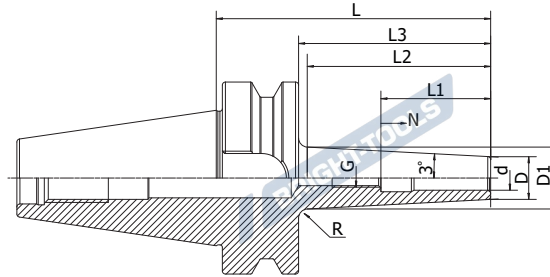
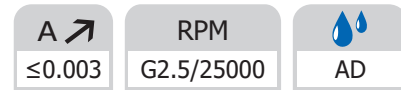

Size	d	D	D1	L	L3	L2	L1	N	G	R
BT30-SFS03-80	03	9	14.8	80	58	55.2	-	-	-	3
BT30-SFS04-80	04	10	15.8	80	58	55.2	-	-	-	3
BT30-SFS06-80	06	12	17.8	80	58	55.2	36	10	M5	3
BT30-SFS08-80	08	14	19.8	80	58	55.2	36	10	M6	3
BT30-SFS10-80	10	16	21.8	80	58	55.2	42	10	M8x1	3
BT30-SFS12-80	12	18	23.8	80	58	55.2	47	10	M10x1	3
BT30-SFS16-80	16	22	27.8	80	58	55.2	50	10	M12x1	3
BT30-SFS06-120	06	12	21.5	120	98	90.6	36	10	M5	3
BT30-SFS08-120	08	14	23.5	120	98	90.6	36	10	M6	3
BT30-SFS10-120	10	16	25.5	120	98	90.6	42	10	M8x1	3
BT30-SFS12-120	12	18	27.5	120	98	90.6	47	10	M10x1	3
BT30-SFS16-120	16	22	31.5	120	98	90.6	50	10	M12x1	3
BT40-SFS03-90	03	9	15.3	90	63	60.2	-	-	-	3
BT40-SFS04-90	04	10	16.3	90	63	60.2	-	-	-	3
BT40-SFS06-90	06	12	18.3	90	63	60.2	36	10	M5	3
BT40-SFS08-90	08	14	20.3	90	63	60.2	36	10	M6	3
BT40-SFS10-90	10	16	22.3	90	63	60.2	42	10	M8x1	3
BT40-SFS12-90	12	18	24.3	90	63	60.2	47	10	M10x1	3
BT40-SFS16-90	16	22	28.3	90	63	60.2	50	10	M12x1	3
BT40-SFS03-120	03	9	18.3	120	93	88.3	-	-	-	5
BT40-SFS04-120	04	10	19.3	120	93	88.3	-	-	-	5
BT40-SFS06-120	06	12	21.3	120	93	88.3	36	10	M5	5
BT40-SFS08-120	08	14	23.3	120	93	88.3	36	10	M6	5
BT40-SFS10-120	10	16	25.3	120	93	88.3	42	10	M8x1	5
BT40-SFS12-120	12	18	27.3	120	93	88.3	47	10	M10x1	5
BT40-SFS16-120	16	22	31.3	120	93	88.3	50	10	M12x1	5
BT40-SFS03-160	03	9	22.4	160	133	128.3	-	-	-	5
BT40-SFS04-160	04	10	23.4	160	133	128.3	-	-	-	5
BT40-SFS06-160	06	12	25.4	160	133	128.3	36	10	M5	5
BT40-SFS08-160	08	14	27.4	160	133	128.3	36	10	M6	5
BT40-SFS10-160	10	16	29.4	160	133	128.3	42	10	M8x1	5
BT40-SFS12-160	12	18	31.4	160	133	128.3	47	10	M10x1	5
BT40-SFS16-160	16	22	35.4	160	133	128.3	50	10	M12x1	5
BT40-SFS20-160	20	27	40.4	160	133	128.3	52	10	M16x1	5

Shrink Fit Chuck, Slim, 3°
热缩刀柄 3 度, 细长型



A ↗ ≤0.003	RPM G2.5/25000	AD
---------------	-------------------	----

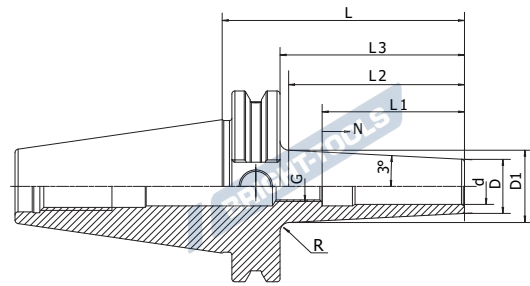

Size	d	D	D1	L	L3	L2	L1	N	G	R
SK40-SFS03-80	03	9	16.1	80	70.9	68.1	-	-	-	3
SK40-SFS04-80	04	10	17.1	80	70.9	68.1	-	-	-	3
SK40-SFS06-80	06	12	19.1	80	70.9	68.1	36	10	M5	3
SK40-SFS08-80	08	14	21.1	80	70.9	68.1	36	10	M6	3
SK40-SFS10-80	10	16	23.1	80	70.9	68.1	42	10	M8x1	3
SK40-SFS12-80	12	18	25.1	80	70.9	68.1	47	10	M10x1	3
SK40-SFS16-80	16	22	29.1	80	70.9	68.1	50	10	M12x1	3
SK40-SFS03-120	03	9	19.1	120	100.9	96.1	-	-	-	5
SK40-SFS04-120	04	10	20.1	120	100.9	96.1	-	-	-	5
SK40-SFS06-120	06	12	22.1	120	100.9	96.1	36	10	M5	5
SK40-SFS08-120	08	14	24.1	120	100.9	96.1	36	10	M6	5
SK40-SFS10-120	10	16	26.1	120	100.9	96.1	42	10	M8x1	5
SK40-SFS12-120	12	18	28.1	120	100.9	96.1	47	10	M10x1	5
SK40-SFS16-120	16	22	32.1	120	100.9	96.1	50	10	M12x1	5
SK40-SFS03-160	03	9	23.3	160	140.9	136.2	-	-	-	5
SK40-SFS04-160	04	10	24.3	160	140.9	136.2	-	-	-	5
SK40-SFS06-160	06	12	26.3	160	140.9	136.2	36	10	M5	5
SK40-SFS08-160	08	14	28.3	160	140.9	136.2	36	10	M6	5
SK40-SFS10-160	10	16	30.3	160	140.9	136.2	42	10	M8x1	5
SK40-SFS12-160	12	18	32.3	160	140.9	136.2	47	10	M10x1	5
SK40-SFS16-160	16	22	36.3	160	140.9	136.2	50	10	M12x1	5



Shrink Fit Chuck, Slim, 3°

热缩刀柄 3 度, 细长型



A ↗ ≤0.003	RPM G2.5/25000	AD
---------------	-------------------	----

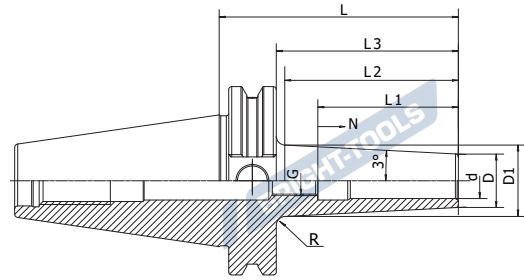

Size	d	D	D1	L	L1	G
CAT40-SFS03-80	03	9	15.5	80	45	M6.0P
CAT40-SFS04-80	04	10	16.3	80	45	M6.0P
CAT40-SFS06-80	06	12	18.3	80	45	M5x0.8P

Inch

Size	d	D	D1	L	L1	G
CAT40-SFS1/8"-3.15"	1/8"	0.35"	0.60"	3.15"	0.78"	M6.0P
CAT40-SFS3/16"-3.15"	3/16"	0.43"	0.68"	3.15"	0.78"	M6.0P
CAT40-SFS1/4"-3.15"	1/4"	0.47"	0.72"	3.15"	1.42"	M5x0.8P
CAT40-SFS3/8"-3.15"	3/8"	0.63"	0.88"	3.15"	1.93"	M8x1.25P
CAT40-SFS1/2"-3.15"	1/2"	0.70"	0.96"	3.15"	1.93"	M10x1.5P

Shrink Fit Chuck, Slim, 3°
热缩刀柄 3 度, 细长型



A ↗ ≤0.003	RPM G2.5/25000	AD
---------------	-------------------	----

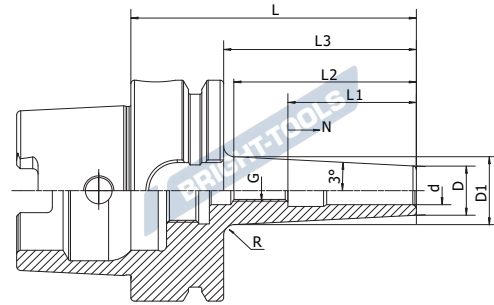

Size	d	D	D1	L	L3	L2	L1	N	G	R
HSK50A-SFS03-80	03	9	14.4	80	54	51.2	-	-	-	3
HSK50A-SFS04-80	04	10	15.4	80	54	51.2	-	-	-	3
HSK50A-SFS06-80	06	12	17.4	80	54	51.2	36	10	M5	3
HSK50A-SFS08-80	08	14	19.4	80	54	51.2	36	10	M6	3
HSK50A-SFS10-85	10	16	21.9	85	59	56.2	42	10	M8x1	3
HSK50A-SFS12-90	12	18	24.4	90	64	61.2	47	10	M10x1	3
HSK50A-SFS16-95	16	22	28.9	95	69	66.2	50	10	M12x1	3
HSK63A-SFS03-80	03	9	14	80	54	47.7	-	-	-	4
HSK63A-SFS04-80	04	10	15.4	80	54	51.2	-	-	-	3
HSK63A-SFS06-80	06	12	17.4	80	54	51.2	36	10	M5	3
HSK63A-SFS08-80	08	14	19.4	80	54	51.2	36	10	M6	3
HSK63A-SFS10-85	10	16	21.8	85	59	56.2	42	10	M8x1	3
HSK63A-SFS12-90	12	18	24.4	90	64	61.2	47	10	M10x1	3
HSK63A-SFS16-95	16	22	28.7	95	69	64.3	50	10	M12x1	5
HSK63A-SFS03-120	03	9	18.4	120	94	89.3	-	-	-	5
HSK63A-SFS04-120	04	10	19.4	120	94	89.3	-	-	-	5
HSK63A-SFS06-120	06	12	21.4	120	94	89.3	36	10	M5	5
HSK63A-SFS08-120	08	14	23.4	120	94	89.3	36	10	M6	5
HSK63A-SFS10-120	10	16	25.4	120	94	89.3	42	10	M8x1	5
HSK63A-SFS12-120	12	18	27.4	120	94	89.3	47	10	M10x1	5
HSK63A-SFS16-120	16	22	31.4	120	94	89.3	50	10	M12x1	5
HSK63A-SFS03-160	03	9	22.5	160	134	129.3	-	-	-	5
HSK63A-SFS04-160	04	10	23.5	160	134	129.3	-	-	-	5
HSK63A-SFS06-160	06	12	25.5	160	134	129.3	36	10	M5	5
HSK63A-SFS08-160	08	14	27.5	160	134	129.3	36	10	M6	5
HSK63A-SFS10-160	10	16	29.5	160	134	129.3	42	10	M8x1	5
HSK63A-SFS12-160	12	18	31.5	160	134	129.3	47	10	M10x1	5
HSK63A-SFS16-160	16	22	35.5	160	134	129.3	50	10	M12x1	5

Shrink Fit Chuck, Slim, 3° 热缩刀柄 3 度, 细长型



A ↗ ≤0.003	RPM G2.5/25000	AD
---------------	-------------------	----

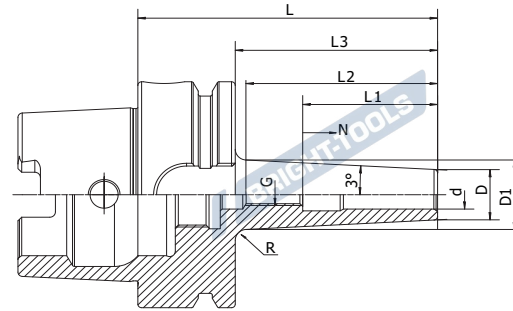

Inch

Size	d	D	L	L3	L1	N	G
HSK63A-SFS1/8-3.15"	0.125"	0.59"	3.15"	2.13"	-	-	-
HSK63A-SFS3/16-3.15"	0.187"	0.59"	3.15"	2.13"	-	-	-
HSK63A-SFS1/4-3.15"	0.250"	0.83"	3.15"	2.13"	1.42"	0.39"	M5
HSK63A-SFS5/16-3.15"	0.312"	0.83"	3.15"	2.13"	1.42"	0.39"	M6
HSK63A-SFS3/8-3.35"	0.375"	0.94"	3.35"	2.32"	1.65"	0.39"	M8x1
HSK63A-SFS1/2-3.54"	0.500"	1.06"	3.54"	2.52"	1.85"	0.39"	M10x1

Shrink Fit Chuck, Slim, 3°
热缩刀柄 3度, 细长型

A ↗ ≤0.003	RPM G2.5/25000	AD
---------------	-------------------	----

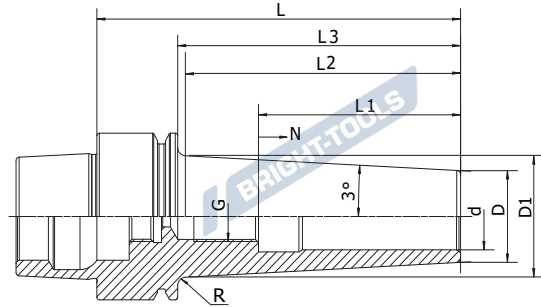

Size	d	D	D1	L	L3	L2	L1	N	G	R
HSK25E-SFS03-50	03	9	—	50	33	—	23	8	M6	—
HSK25E-SFS04-50	04	10	—	50	33	—	20	4	M6	—
HSK25E-SFS05-50	05	11	—	50	33	—	20	3	M6	—
HSK25E-SFS06-50	06	12	—	50	33	—	36	—	—	—
HSK25E-SFS08-50	08	14	—	50	38	—	36	—	—	—
HSK25E-SFS10-50	10	16	—	50	40	—	42	—	—	—
HSK32E-SFS03-60	03	9	13.3	60	44	41.2	20	5	M6	3
HSK32E-SFS04-60	04	10	14.3	60	44	41.2	20	5	M6	3
HSK32E-SFS06-70	06	12	17.4	70	54	51.2	36	5	M5	3
HSK32E-SFS08-70	08	14	19.36	70	54	51.2	36	5	M6	3
HSK32E-SFS10-80	10	16	22.4	80	64	61.2	42	5	M8x1	3
HSK40E-SFS03-50	03	9	11.9	50	30	27.2	20	—	—	3
HSK40E-SFS04-50	04	10	12.9	50	30	27.2	20	—	—	3
HSK40E-SFS06-60	06	12	15.9	60	40	37.2	36	10	M5	3
HSK40E-SFS08-60	08	14	17.9	60	40	37.2	36	10	—	3
HSK40E-SFS10-60	10	16	19.9	60	40	37.2	42	10	—	3
HSK40E-SFS12-60	12	18	21.9	60	40	37.2	42	10	—	3
HSK40E-SFS16-70	16	22	27	70	50	48.1	50	10	—	2
HSK50E-SFS03-60	03	9	12.3	60	34	31.2	—	—	—	3
HSK50E-SFS04-80	04	10	15.4	80	54	51.2	—	—	—	3
HSK50E-SFS06-80	06	12	17.4	80	54	51.2	36	10	M5	3
HSK50E-SFS08-80	08	14	19.4	80	54	51.2	36	10	M6	3
HSK50E-SFS10-90	10	16	22.4	90	64	61.2	42	10	M8x1	3
HSK50E-SFS12-90	12	18	24.4	90	64	61.2	47	10	M10x1	3
HSK50E-SFS16-90	16	22	28.4	90	64	61.2	50	10	M16x1	3



Shrink Fit Chuck, Slim, 3°

热缩刀柄 3 度, 细长型

A ↗ ≤0.003	RPM G2.5/25000	AD
---------------	-------------------	----

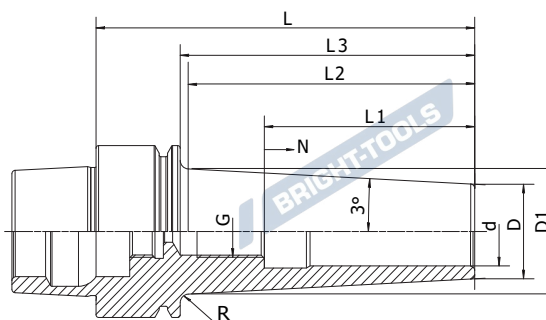

Inch

Size	d	D	D1	L	L3	L1	N	G
HSK40E-SFS1/8-2.36"	1/8"	0.36"	0.63"	2.36"	1.57"	0.78"	–	M6 x 1.0
HSK40E-SFS3/16-2.36"	3/16"	0.43"	0.69"	2.36"	1.57"	0.78"	–	M6 x 1.0
HSK40E-SFS1/4-2.36"	1/4"	0.47"	0.81"	2.36"	1.57"	1.42"	0.39"	M5 x 0.8
HSK40E-SFS3/8-2.36"	3/8"	0.63"	0.94"	2.36"	1.57"	1.65"	0.39"	M8 x 1.25
HSK40E-SFS1/2-2.36"	1/2"	0.71"	1.06"	2.36"	1.57"	1.85"	0.39"	M10 x 1.5
HSK50E-SFS1/8-2.76	0.125	0.39	0.55	2.76	1.65	0.79	–	M6
HSK50E-SFS3/16-2.76	0.187	0.39	0.55	2.76	1.65	0.98	–	M6
HSK50E-SFS1/4-2.76	0.25	0.47	0.63	2.76	1.65	1.42	0.39"	M5
HSK50E-SFS3/8-2.76	0.375	0.63	0.79	2.76	1.65	1.65	0.39"	
HSK50E-SFS1/2-2.76	0.5	0.71	0.87	2.76	1.65	1.85	0.39"	–
HSK50E-SFS5/8-2.76	0.625	0.87	1.02	2.76	1.65	1.85	0.39"	–
HSK50E-SFS1/4-3.54	0.25	0.47	0.71	3.54	2.36	1.42	0.39"	M5
HSK50E-SFS3/8-3.54	0.375	0.63	0.87	3.54	2.36	1.65	0.39"	M8x1
HSK50E-SFS1/2-3.54	0.5	0.79	1.02	3.54	2.36	1.85	0.39"	M10x1
HSK50E-SFS5/8-3.54	0.625	0.87	1.1	3.54	2.36	1.97	0.39"	M10x1
HSK50E-SFS1/8-3.94	0.125	0.39	0.67	3.94	2.76	0.79	–	M6
HSK50E-SFS3/16-3.94	0.187	0.43	0.71	3.94	2.76	0.98	–	M6
HSK50E-SFS1/4-4.72	0.25	0.47	0.83	4.72	3.54	1.42	0.39"	M5
HSK50E-SFS3/8-4.72	0.375	0.63	0.98	4.72	3.54	1.65	0.39"	M8x1
HSK50E-SFS1/2-4.72	0.5	0.79	1.14	4.72	3.54	1.85	0.39"	M10x1
HSK50E-SFS5/8-4.72	0.625	0.87	1.22	4.72	3.54	1.97	0.39"	M10x1

Shrink Fit Extension, 3° 3° 直柄热缩延长杆

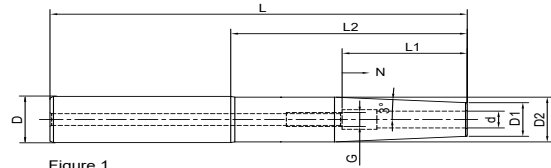

Figure 1



Figure 2

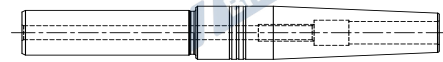

Figure 3

Size	d	D1	D2	D	L	L1	L2	N	G	Figure
C12-SFS03-120	03	9	-	12	120	-	-	-	-	2
C12-SFS04-120	04	10	-	12	120	-	-	-	-	2
C12-SFS05-120	05	11	-	12	120	-	-	-	-	2
C12-SFS06-120	06	12	17	12	120	36	73	10	M5	3
C12-SFS08-120	08	14	19	12	120	36	73	10	M6	3
C16-SFS03-120	03	9	-	16	120	-	-	-	-	2
C16-SFS04-120	04	10	-	16	120	-	-	-	-	2
C16-SFS05-120	05	11	-	16	120	-	-	-	-	2
C16-SFS06-120	06	12	-	16	120	36	-	10	M5	2
C16-SFS08-120	08	14	-	16	120	36	-	10	M6	2
C20-SFS03-120	03	9	15.5	20	120	-	68	-	-	1
C20-SFS04-120	04	10	16.5	20	120	-	68	-	-	1
C20-SFS05-120	05	11	17.5	20	120	-	68	-	-	1
C20-SFS06-120	06	12	18	20	120	36	68	10	M5	1
C20-SFS08-120	08	14	-	20	120	36	-	10	M6	2
C20-SFS10-120	10	16	-	20	120	42	-	10	M8x1	2
C20-SFS12-120	12	18	-	20	120	47	-	10	M10x1	2
C12-SFS03-160	03	9	-	12	160	-	-	-	-	2
C12-SFS04-160	04	10	-	12	160	-	-	-	-	2
C16-SFS03-160	03	9	-	16	160	-	-	-	-	2
C16-SFS04-160	04	10	-	16	160	-	-	-	-	2
C16-SFS05-160	05	11	-	16	160	-	-	-	-	2
C16-SFS06-160	06	12	-	16	160	36	-	10	M5	2
C16-SFS08-160	08	14	-	16	160	36	-	10	M6	2
C16-SFS10-160	10	16	21	16	160	42	110	10	M8x1	3



Shrink Fit Extension, 3° 3° 直柄热缩延长杆

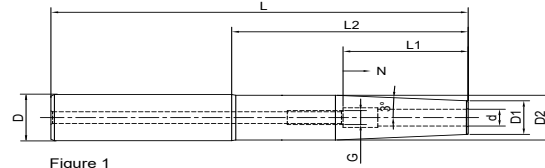

Figure 1

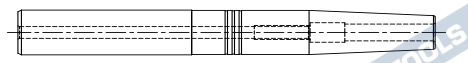

Figure 2

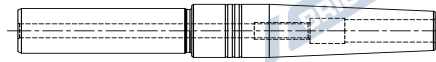

Figure 3

Size	d	D1	D2	D	L	L1	L2	N	G	Figure
C20-SFS05-160	05	11	-	20	160	-	-	-	-	2
C20-SFS06-160	06	12	-	20	160	36	-	10	M5	2
C20-SFS08-160	08	14	-	20	160	36	-	10	M6	2
C25-SFS08-160	08	14	-	25	160	36	-	10	M6	2
C25-SFS10-160	10	16	-	25	160	42	-	10	M8x1	2
C25-SFS12-160	12	18	-	25	160	47	-	10	M10x1	2
C25-SFS14-160	14	20	-	25	160	47	-	10	M10x1	2
C25-SFS16-160	16	22	-	25	160	50	-	10	M12x1	2
C32-SFS10-160	10	16	25	32	160	42	98	10	M8x1	1
C32-SFS12-160	12	18	27	32	160	47	98	10	M10x1	1
C32-SFS14-160	14	20	29	32	160	47	98	10	M10x1	1
C32-SFS16-160	16	22	-	32	160	50	-	10	M12x1	2
C32-SFS18-160	18	25	-	32	160	50	-	10	M12x1	2
C32-SFS20-160	20	26	-	32	160	52	-	10	M16x1	2
C16-SFS03-200	03	9	-	16	200	-	-	-	-	2
C16-SFS04-200	04	10	-	16	200	-	-	-	-	2
C16-SFS05-200	05	11	-	16	200	-	-	-	-	2
C16-SFS06-200	06	12	-	16	200	36	-	10	M5	2
C16-SFS08-200	08	14	-	16	200	36	-	10	M6	2
C20-SFS04-200	04	10	-	20	200	-	-	-	-	2
C20-SFS06-200	06	12	-	20	200	36	-	10	M5	2
C20-SFS08-200	08	14	-	20	200	36	-	10	M6	2
C20-SFS10-200	10	16	-	20	200	42	-	10	M8x1	2
C20-SFS06-250	06	12	-	20	250	36	-	10	M5	2
C20-SFS08-250	08	14	-	20	250	36	-	10	M6	2
C20-SFS10-250	10	16	-	20	250	42	-	10	M8x1	2
C25-SFS12-250	12	18	-	25	250	47	-	10	M10x1	2
C25-SFS16-250	16	22	-	25	250	50	-	10	M12x1	2
C20-SFS06-300	06	12	-	20	300	36	-	10	M5	2
C20-SFS08-300	08	14	-	20	300	36	-	10	M6	2
C20-SFS10-300	10	16	-	20	300	42	-	10	M8x1	2
C25-SFS12-300	12	18	-	25	300	47	-	10	M10x1	2
C25-SFS16-300	16	22	-	25	300	50	-	10	M12x1	2

Shrink Fit Extension, 3° 3° 直柄热缩延长杆



Inch

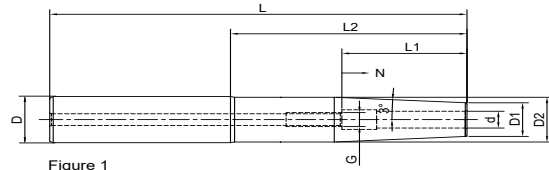

Figure 1

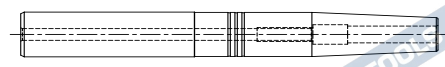

Figure 2

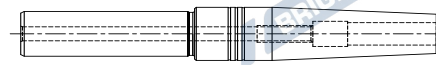

Figure 3

Size	d	D1	D2	D	L	L1	L2	N	G	Figure
C1/2-1/8-4.33	1/8	0.39	1/2	1/2	4.33	0.79	2.48	0.2	M6	2
C3/4-1/8-4.33	1/8	0.39	3/4	3/4	4.33	0.98	2.28	0.2	M6	1
C1/2-1/4-4.33	1/4	0.47	1/2	1/2	4.33	1.42	2.48	0.39	M5	3
C3/4-1/4-4.33	1/4	0.47	3/4	3/4	4.33	1.42	2.28	0.39	M5	1
C3/4-3/8-4.33	3/8	0.63	3/4	3/4	4.33	1.65	2.28	0.39	M8*1	2
C3/4-1/8-9.84	1/8	0.39	3/4	3/4	9.84	0.79	7.79	0.2	M6	1
C3/4-1/4-9.84	1/4	0.47	3/4	3/4	9.84	1.42	7.79	0.39	M5	1
C3/4-3/8-9.84	3/8	0.63	3/4	3/4	9.84	1.65	7.79	0.39	M8*1	2
C3/4-1/2-9.84	1/2	0.79	1	3/4	9.84	1.85	7.59	0.39	M10*1	1
C1-1/2-9.84	1/2	0.87	1	1	9.84	1.85	7.59	0.39	M10*1	1
C1-5/8-9.84	5/8	0.87	1	1	9.84	1.97	7.59	0.39	M12*1	2



Shrink Fit ER Collet

ER 热缩夹头

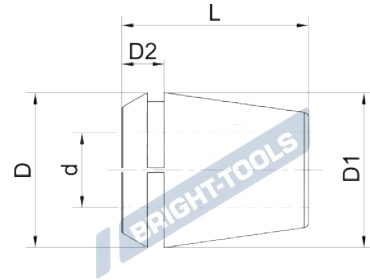

Size	Collet Size	d	D1	D2	L
ER16-SF03	ER16	03	16	6.7	27.5
ER16-SF04	ER16	04	16	6.7	27.5
ER16-SF05	ER16	05	16	6.7	27.5
ER16-SF06	ER16	06	16	6.7	27.5
ER16-SF08	ER16	08	16	6.7	27.5
ER16-SF10	ER16	10	16	6.7	27.5
ER20-SF03	ER20	03	20	7.52	31.5
ER20-SF04	ER20	04	20	7.52	31.5
ER20-SF05	ER20	05	20	7.52	31.5
ER20-SF06	ER20	06	20	7.52	31.5
ER20-SF08	ER20	08	20	7.52	31.5
ER20-SF10	ER20	10	20	7.52	31.5
ER20-SF12	ER20	12	20	7.52	31.5
ER25-SF03	ER25	03	25	8	34
ER25-SF04	ER25	04	25	8	34
ER25-SF05	ER25	05	25	8	34
ER25-SF06	ER25	06	25	8	34
ER25-SF08	ER25	08	25	8	34
ER25-SF10	ER25	10	25	8	34
ER25-SF12	ER25	12	25	8	34
ER25-SF14	ER25	14	25	8	34
ER25-SF16	ER25	16	25	8	34
ER32-SF03	ER32	03	32	9	40
ER32-SF04	ER32	04	32	9	40
ER32-SF05	ER32	05	32	9	40
ER32-SF06	ER32	06	32	9	40
ER32-SF08	ER32	08	32	9	40
ER32-SF10	ER32	10	32	9	40
ER32-SF12	ER32	12	32	9	40
ER32-SF14	ER32	14	32	9	40
ER32-SF16	ER32	16	32	9	40
ER32-SF18	ER32	18	32	9	40
ER32-SF20	ER32	20	32	9	40

Shrink Fit ER Collet Extension ER 热缩延长杆

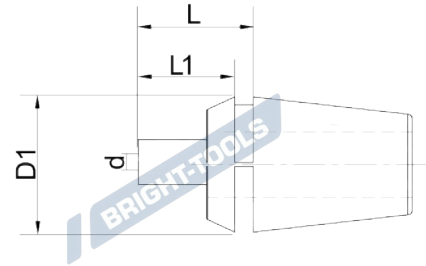
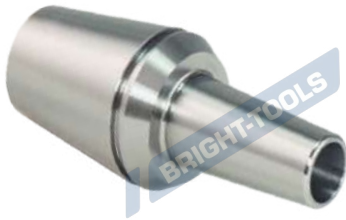

Size	Collet Size	d	D1	L	L1
ER16-SFS03-35	ER16	03	16	41.7	35
ER16-SFS04-35	ER16	04	16	41.7	35
ER16-SFS05-35	ER16	05	16	41.7	35
ER16-SFS06-35	ER16	06	16	41.7	35
ER20-SFS03-35	ER20	03	20	42.52	35
ER20-SFS04-35	ER20	04	20	42.52	35
ER20-SFS05-35	ER20	05	20	42.52	35
ER20-SFS06-35	ER20	06	20	42.52	35
ER20-SFS08-35	ER20	08	20	42.52	35
ER25-SFS03-35	ER25	03	25	43	35
ER25-SFS04-35	ER25	04	25	43	35
ER25-SFS05-35	ER25	05	25	43	35
ER25-SFS06-35	ER25	06	25	43	35
ER25-SFS08-35	ER25	08	25	43	35
ER25-SFS10-35	ER25	10	25	43	35
ER32-SFS03-35	ER32	03	32	44	35
ER32-SFS04-35	ER32	04	32	44	35
ER32-SFS05-35	ER32	05	32	44	35
ER32-SFS06-35	ER32	06	32	44	35
ER32-SFS08-35	ER32	08	32	44	35
ER32-SFS10-35	ER32	10	32	44	35
ER32-SFS12-35	ER32	12	32	44	35
ER32-SFS14-35	ER32	14	32	44	35
ER32-SFS16-35	ER32	16	32	44	35



Shrink Chuck Set

热缩刀柄套装

A ↗
≤0.003

RPM
G2.5/25000



AD



Size	Tool Holder Size	Extension Size	Extension Quantity
BT40-SF16-90-4 pcs	BT40-SF16-90	C16-SFS03/04/06/08-160	4
BT40-SF16-90-4 pcs	BT40-SF16-90	C16-SFS03/04/06/08-160	4
BT40-SF20-90-6 pcs	BT40-SF20-90	C20-SFS03/04/06/08/10/12-160	6
SK40-SF16-90-4 pcs	SK40-SF16-90	C12-SFS03/04/06/08-160	4
SK40-SF16-90-4 pcs	SK40-SF16-90	C16-SFS03/04/06/08-160	4
SK40-SF20-90-6 pcs	SK40-SF20-90	C20-SFS03/04/06/08/10/12-160	6
HSK63A-SF16-90-4 pcs	HSK63A-SF16-90	C12-SFS03/04/06/08-160	4
HSK63A-SF16-90-4 pcs	HSK63A-SF16-90	C16-SFS03/04/06/08-160	4
HSK63A-SF20-90-6 pcs	HSK63A-SF20-90	C20-SFS03/04/06/08/10/12-160	6

MQL1 Channel Length Setting Screws

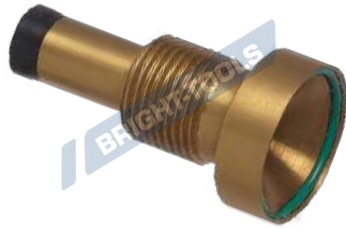
微润滑单通道长度调节螺钉



Type 1

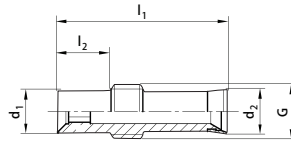

Type 2

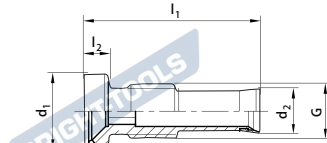

Size	HSK-A	d1	d2	L1	L2	G	SW	Type
MQL10060320	32	06	4.0	34.5	2.5	M5x0.8	2	2
MQL10080320	32	08	4.0	34.5	3.0	M7x1	2	2
MQL10100320	32	10	4.0	35.5	3.5	M8x1	2	2
MQL10120320	32	12	4.0	35.5	3.5	M10x1	2	2
MQL10060400	40	06	5.4	34.1	11.0	M7x1	3	1
MQL10080400	40	08	5.4	34.1	3.0	M7x1	3	2
MQL10100400	40	10	5.4	30.1	3.5	M8x1	3	2
MQL10120400	40	12	5.4	35.1	3.5	M10x1	3	2
MQL10140400	40	14	5.4	35.1	4.5	M10x1	3	2
MQL10160400	40	16	5.4	32.1	5.5	M12x1	3	2
MQL10060500	50	06	6.5	31.8	10.0	M8x1	4	1
MQL10080500	50	08	6.5	31.8	3.0	M8x1	4	2
MQL10100500	50	10	6.5	32.8	3.5	M8x1	4	2
MQL10120500	50	12	6.5	32.8	3.5	M10x1	4	2
MQL10140500	50	14	6.5	32.8	4.5	M10x1	4	2
MQL10160500	50	16	6.5	34.8	5.5	M12x1	4	2
MQL10180500	50	18	6.5	34.8	6.5	M12x1	4	2
MQL10200500	50	20	6.5	37.8	6.5	M16x1	4	2
MQL10061000	63/80/100	06	8.0	31	10.0	M10x1	4	1
MQL10081000	63/80/100	08	8.0	31.8	10.0	M10x1	4	1
MQL10101000	63/80/100	10	8.0	32.8	3.5	M10x1	4	2
MQL10121000	63/80/100	12	8.0	32.8	3.5	M10x1	5	2
MQL10141000	63/80/100	14	8.0	32.8	4.5	M10x1	5	2
MQL10161000	63/80/100	16	8.0	34.8	5.5	M12x1	5	2
MQL10181000	63/80/100	18	8.0	34.8	6.5	M12x1	5	2
MQL10201000	63/80/100	20	8.0	37.8	6.5	M16x1	5	2
MQL10251000	63/80/100	25	8.0	43.8	10.0	M16x1	5	2
MQL10321000	63/80/100	32	8.0	44.8	14.0	M16x1	5	2



MQL2 Channel Length Setting Screws

微润滑双通道长度调节螺钉



Type 1

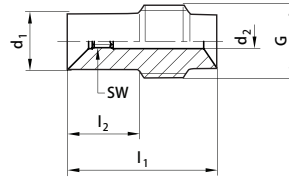

Type 2

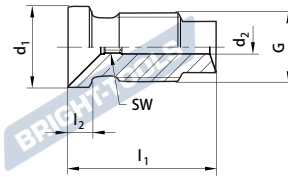

Size	HSK-A	d1	A	d1	L1	L2	G	SW	Type
MQL20060320	32	06	2.01	2	25.8	2.5	M5x0.8	1.5	2
MQL20061320	32	06	4.15	2.9	25.8	2.5	M5x0.8	2	2
MQL20080320	32	08	2.01	2	21	3	M7x1	1.5	2
MQL20081320	32	08	4.15	2.9	21	3	M7x1	2	2
MQL20100320	32	10	2.01	2	22	3.5	M8x1	1.5	2
MQL20101320	32	10	4.15	2.9	22	3.5	M8x1	2	2
MQL20120320	32	12	2.01	2	22	3.5	M10x1	1.5	2
MQL20121320	32	12	4.15	2.9	22	3.5	M10x1	2	2
MQL20060400	40	06	2.01	2	26.5	11	M7x1	1.5	1
MQL20061400	40	06	4.15	2.9	26.5	11	M7x1	2	1
MQL20080400	40	08	2.01	2	26.5	3	M7x1	1.5	2
MQL20081400	40	08	4.15	2.9	26.5	3	M7x1	2	2
MQL20100400	40	10	2.01	2	22.2	3.5	M8x1	1.5	2
MQL20101400	40	10	4.15	2.9	22.2	3.5	M8x1	2	2
MQL20120400	40	12	2.01	2	26.5	3.5	M10x1	1.5	2
MQL20121400	40	12	4.15	2.9	26.5	3.5	M10x1	2	2
MQL20122400	40	12	9.08	4.1	26.5	3.5	M10x1	3	2
MQL20140400	40	14	2.01	2	26.5	4.5	M10x1	1.5	2
MQL20141400	40	14	4.15	2.9	26.5	4.5	M10x1	2	2
MQL20142400	40	14	9.08	4.1	26.5	4.5	M10x1	3	2
MQL20160400	40	16	2.01	2	23.5	5.5	M12x1	1.5	2
MQL20161400	40	16	4.15	2.9	23.5	5.5	M12x1	2	2
MQL20162400	40	16	9.08	4.1	23.5	5.5	M12x1	3	2

MQL2 Channel Length Setting Screws

微润滑双通道长度调节螺钉



Type 1

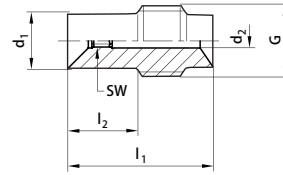

Type 2

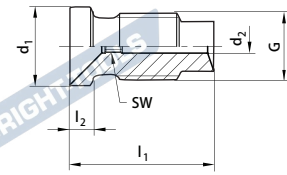

Size	HSK-A	d1	A	d1	L1	L2	G	SW	Type
MQL20060500	50	06	2.01	2	22	10	M8x1	1.5	1
MQL20061500	50	06	4.15	2.9	22	10	M8x1	2	1
MQL20080500	50	08	2.01	2	22	3	M8x1	1.5	2
MQL20081500	50	08	4.15	2.9	22	3	M8x1	2	2
MQL20100500	50	10	2.01	2	23	3.5	M8x1	1.5	2
MQL20101500	50	10	4.15	2.9	23	3.5	M8x1	2	2
MQL20120500	50	12	2.01	2	23.7	3.5	M10x1	1.5	2
MQL20121500	50	12	4.15	2.9	23.7	3.5	M10x1	2	2
MQL20122500	50	12	9.08	4.1	23.7	3.5	M10x1	3	2
MQL20140500	50	14	2.01	2	23.7	4.5	M10x1	1.5	2
MQL20141500	50	14	4.15	2.9	23.7	4.5	M10x1	2	2
MQL20142500	50	14	9.08	4.1	23.7	4.5	M10x1	3	2
MQL20160500	50	16	2.01	2	25.7	5.5	M12x1	1.5	2
MQL20161500	50	16	4.15	2.9	25.7	5.5	M12x1	2	2
MQL20162500	50	16	9.08	4.1	25.7	5.5	M12x1	3	2
MQL20180500	50	18	2.01	2	25.7	6.5	M12x1	1.5	2
MQL20181500	50	18	4.15	2.9	25.7	6.5	M12x1	2	2
MQL20182500	50	18	9.08	4.1	25.7	6.5	M12x1	3	2
MQL20200500	50	20	4.15	2.9	27.5	6.5	M16x1	2	2
MQL20201500	50	20	9.08	4.1	27.5	6.5	M16x1	3	2
MQL20202500	50	20	16.62	5.4	27.5	6.5	M16x1	4	2



MQL2 Channel Length Setting Screws

微润滑双通道长度调节螺钉



Type 1

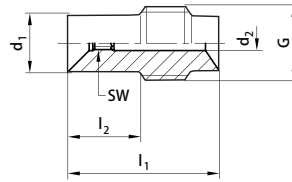

Type 2

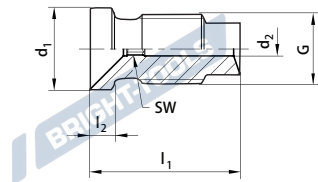

Size	HSK-A	d1	A	d1	L1	L2	G	SW	Type
MQL20061000	63/80/100	06	2	2	21	10	M10x1	2	1
MQL20061010	63/80/100	06	4.15	2.9	20.5	10	M10x1	2	1
MQL20081000	63/80/100	08	2.01	2	21.3	10	M10x1	1.5	1
MQL20081010	63/80/100	08	4.15	2.9	21.3	10	M10x1	2	1
MQL20101000	63/80/100	10	2.01	2	21.2	3.5	M10x1	1.5	2
MQL20101010	63/80/100	10	4.15	2.9	21.2	3.5	M10x1	2	2
MQL20121000	63/80/100	12	2.01	2	21.7	3.5	M10x1	1.5	2
MQL20121010	63/80/100	12	4.15	2.9	21.7	3.5	M10x1	2	2
MQL20121020	63/80/100	12	9.08	4.1	21.7	3.5	M10x1	3	2
MQL20141000	63/80/100	14	2.01	2	21.8	4.5	M10x1	1.5	2
MQL20141010	63/80/100	14	4.15	2.9	21.8	4.5	M10x1	2	2
MQL20141020	63/80/100	14	9.08	4.1	21.8	4.5	M10x1	3	2
MQL20161000	63/80/100	16	2.01	2	23.7	5.5	M12x1	1.5	2
MQL20161010	63/80/100	16	4.15	2.9	23.7	5.5	M12x1	2	2
MQL20161020	63/80/100	16	9.08	4.1	23.7	5.5	M12x1	3	2
MQL20181000	63/80/100	18	2.01	2	23.8	6.5	M12x1	1.5	2
MQL20181010	63/80/100	18	4.15	2.9	23.8	6.5	M12x1	2	2
MQL20181020	63/80/100	18	9.08	4.1	23.8	6.5	M12x1	3	2
MQL20201000	63/80/100	20	4.15	2.9	26.7	6.5	M16x1	2	2
MQL20201010	63/80/100	20	9.08	4.1	26.7	6.5	M16x1	3	2
MQL20201020	63/80/100	20	16.62	5.4	26.7	6.5	M16x1	4	2
MQL20251000	63/80/100	25	4.15	2.9	30.6	10	M16x1	2	2
MQL20251010	63/80/100	25	9.08	4.1	30.6	10	M16x1	3	2
MQL20251020	63/80/100	25	16.62	5.4	30.6	10	M16x1	4	2
MQL20321000	63/80/100	32	4.15	2.9	31.6	14	M16x1	2	2
MQL20321010	63/80/100	32	9.08	4.1	31.6	14	M16x1	3	2
MQL20321020	63/80/100	32	16.62	5.4	31.6	14	M16x1	4	2

MQL1 Channel Coolant Supply Set

微润滑单通道冷却导管

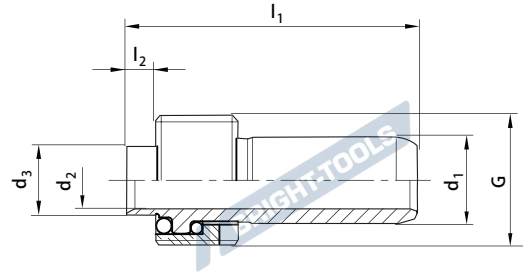

Size	HSK-A	d1	d2	d3	L1	L2	G
MQL10100320	32	06	4	5	39	13	M10x1.0
MQL10120400	40	08	5.4	6.5	35.0	5.5	M12x1.0
MQL10160500	50	10	6.5	7.5	38.5	5.5	M16x1.0
MQL10180630	63	12	8.0	9.5	40.5	4.0	M18x1.0
MQL10200800	80	14	8.0	9.7	44.0	4.0	M20x1.5
MQL10241000	100	16	8.0	11.5	46.0	2.0	M24x1.5



MQL2 Channel Coolant Supply Set

微润滑双通道冷却导管

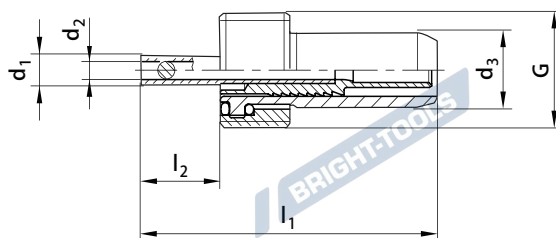

Size	HSK-A	clamp	A	d1	d2	d3	l1	l2	G
MQL20120320	32	6-12	2.01	1.9	1.6	6	47	20.6	M10x1
MQL20121320	32	6-12	4.15	2.8	2.3	6	47	20.6	M10x1
MQL20160400	40	6/16	2.01	1.9	1.6	8	43.3	14.5	M12x1
MQL20161400	40	6/16	4.15	2.8	2.3	8	43.3	14.5	M12x1
MQL20162400	40	12/16	9.08	4.0	3.4	8	43.1	14.3	M12x1
MQL20100500	50	6/10	2.01	1.9	1.6	10	48.6	16.0	M16x1.0
MQL20101500	50	6/10	4.15	2.8	2.3	10	48.6	16.0	M16x1.0
MQL20180500	50	12/18	2.01	1.9	1.6	10	46.5	13.9	M16x1.0
MQL20200500	50	12/20	4.15	2.8	2.3	10	46.5	13.9	M16x1.0
MQL20201500	50	12/20	9.08	4.0	3.4	10	46.5	13.9	M16x1.0
MQL20202500	50	20	16.62	5.3	4.6	10	46.5	13.9	M16x1.0
MQL20100630	63	6/10	2.01	1.9	1.6	12	50.0	14.1	M18x1.0
MQL20101630	63	6/10	4.15	2.8	2.3	12	50.0	14.1	M18x1.0
MQL20180630	63	12/18	2.01	1.9	1.6	12	48.8	13.0	M18x1.0
MQL20200630	63	12/20	4.15	2.8	2.3	12	48.8	13.0	M18x1.0
MQL20201630	63	12/20	9.08	4.0	3.4	12	48.8	13.0	M18x1.0
MQL20202630	63	20	16.62	5.3	4.6	12	50.0	14.2	M18x1.0
MQL20320630	63	25-32	4.15	2.8	2.3	12	54.1	18.3	M18x1.0
MQL20321630	63	25-32	9.08	4.0	3.4	12	54.1	18.3	M18x1.0
MQL20322630	63	25-32	16.62	5.3	4.6	12	54.1	18.3	M18x1.0
MQL22080630	63	6/8	2.01	1.9	1.6	12	90.0	54.1	M18x1.0
MQL22081630	63	6/8	4.15	2.8	2.3	12	90.0	54.1	M18x1.0
MQL22100630	63	10	2.01	1.9	1.6	12	85.0	49.1	M18x1.0
MQL22101630	63	10	4.15	2.8	2.3	12	85.0	49.1	M18x1.0
MQL22140630	63	12/14	2.01	1.9	1.6	12	78.8	43.0	M18x1.0
MQL22141630	63	12/14	4.15	2.8	2.3	12	78.8	43.0	M18x1.0
MQL22142630	63	12/14	9.08	4.0	3.4	12	78.8	43.0	M18x1.0
MQL22180630	63	16-18	2.01	1.9	1.6	12	73.8	38.0	M18x1.0
MQL22181630	63	16-18	4.15	2.8	2.3	12	73.8	38.0	M18x1.0
MQL22182630	63	16-18	9.08	4.0	3.4	12	73.8	38.0	M18x1.0

MQL2 Channel Coolant Supply Set

微润滑双通道冷却导管

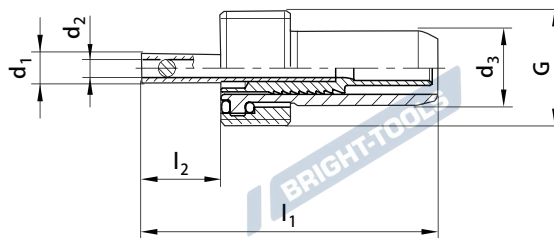

Size	HSK-A	clamp	A	d1	d2	d3	l1	l2	G
MQL22200630	63	20	4.15	2.8	2.3	12	70.0	34.2	M18x1.0
MQL22201630	63	20	9.08	4.0	3.4	12	70.0	34.2	M18x1.0
MQL22202630	63	20	16.62	5.3	4.6	12	70.0	34.2	M18x1.0
MQL21080630	63	6/8	2.01	1.9	1.6	12	130.0	94.1	M18x1.0
MQL21081630	63	6/8	4.15	2.8	2.3	12	130.0	94.1	M18x1.0
MQL21100630	63	10	2.01	1.9	1.6	12	125.0	89.1	M18x1.0
MQL21101630	63	10	4.15	2.8	2.3	12	125.0	89.1	M18x1.0
MQL21140630	63	12/14	2.01	1.9	1.6	12	118.8	83.0	M18x1.0
MQL21141630	63	12/14	4.15	2.8	2.3	12	118.8	83.0	M18x1.0
MQL21142630	63	12/14	9.08	4.0	3.4	12	118.8	83.0	M18x1.0
MQL21180630	63	16-18	2.01	1.9	1.6	12	113.8	78.0	M18x1.0
MQL21181630	63	16-18	4.15	2.8	2.3	12	113.8	78.0	M18x1.0
MQL21182630	63	16-18	9.08	4.0	3.4	12	113.8	78.0	M18x1.0
MQL21200630	63	20	4.15	2.8	2.3	12	110.0	74.2	M18x1.0
MQL21201630	63	20	9.08	4.0	3.4	12	110.0	74.2	M18x1.0
MQL21202630	63	20	16.62	5.3	4.6	12	110.0	74.2	M18x1.0
MQL21250630	63	25	4.15	2.8	2.3	12	99.1	63.3	M18x1.0
MQL21251630	63	25	9.08	4	3.4	12	99.1	63.3	M18x1.0
MQL21252630	63	25	16.62	5.3	4.6	12	99.1	63.3	M18x1.0
MQL21320630	63	32	4.15	2.8	2.3	12	94.1	58.3	M18x1.0
MQL21321630	63	32	9.08	4.0	3.4	12	94.1	58.3	M18x1.0
MQL21322630	63	32	16.62	5.3	4.6	12	94.1	58.3	M18x1.0
MQL20100800	80	6/10	2.01	1.9	1.6	14	54.2	14.6	M20x1.5
MQL20101800	80	6/10	4.15	2.8	2.3	14	54.2	14.6	M20x1.5
MQL20180800	80	12 -18	2.01	1.9	1.6	14	53.1	13.5	M20x1.5
MQL20320800	80	12 -32	4.15	2.8	2.3	14	53.1	13.5	M20x1.5
MQL20321800	80	12 -32	9.08	4.0	3.4	14	53.1	13.5	M20x1.5
MQL20322800	80	20-32	16.62	5.3	4.6	14	53.6	14.0	M20x1.5



MQL2 Channel Coolant Supply Set

微润滑双通道冷却导管

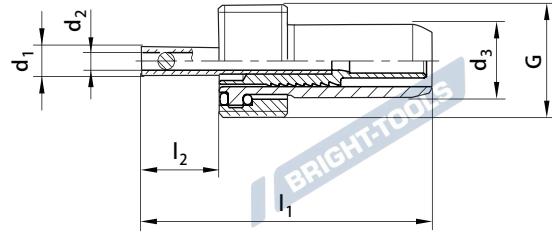

Size	HSK-A	clamp	A	d1	d2	d3	l1	l2	G
MQL20101000	100	6/10	2.01	1.9	1.6	14	56.2	12.6	M24x1.5
MQL20101010	100	6/10	4.15	2.8	2.3	14	56.2	12.6	M24x1.5
MQL20181000	100	12/18	2.01	1.9	1.6	14	55.1	11.5	M24x1.5
MQL20321000	100	12/32	4.15	2.8	2.3	14	55.1	11.5	M24x1.5
MQL20321010	100	12/32	9.08	4.0	3.4	14	55.1	11.5	M24x1.5
MQL20321020	100	20-32	16.62	5.3	4.6	14	55.6	12.0	M24x1.5
MQL21081000	100	6/8	2.01	1.9	1.6	12	131.2	87.6	M24x1.5
MQL21081010	100	6/8	4.15	2.8	2.3	12	131.2	87.6	M24x1.5
MQL21101000	100	10	2.01	1.9	1.6	12	126.2	82.6	M24x1.5
MQL21101010	100	10	4.15	2.8	2.3	12	126.2	82.6	M24x1.5
MQL21141000	100	12/14	2.01	1.9	1.6	12	120.1	76.5	M24x1.5
MQL21141010	100	12/14	4.15	2.8	2.3	12	120.1	76.5	M24x1.5
MQL21141020	100	12/14	9.08	4.0	3.4	12	120.1	76.5	M24x1.5
MQL21181000	100	16-18	2.01	1.9	1.6	12	115.1	71.5	M24x1.5
MQL21181010	100	16-18	4.15	2.8	2.3	12	115.1	71.5	M24x1.5
MQL21181020	100	16-18	9.08	4.0	3.4	12	115.1	71.5	M24x1.5
MQL21201000	100	20	4.15	2.8	2.3	12	110.6	67.0	M24x1.5
MQL21201010	100	20	9.08	4.0	3.4	12	110.6	67.0	M24x1.5
MQL21201020	100	20	16.62	5.3	4.6	12	110.6	67.0	M24x1.5
MQL21251000	100	25	4.15	2.8	2.3	12	100.6	57.0	M24x1.5
MQL21251010	100	25	9.08	4.0	3.4	12	100.6	57.0	M24x1.5
MQL21251020	100	25	16.62	5.3	4.6	12	100.6	57.0	M24x1.5
MQL21321000	100	32	4.15	2.8	2.3	12	95.6	52.0	M24x1.5
MQL21321010	100	32	9.08	4.0	3.4	12	95.6	52.0	M24x1.5
MQL21321020	100	32	16.62	5.3	4.6	12	95.6	52.0	M24x1.5

BRIGHT-TOOLS

BRIGHT-TOOLS

TOOL HOLDERS MODULAR SHRINK

BRIGHT-TOOLS

BRIGHT-TOOLS

BRIGHT-TOOLS

BRIGHT-TOOLS

BRIGHT-TOOLS

BRIGHT-TOOLS

Shrink Chuck Taper
分体热缩本体，标准型

A ↗
≤0.003

RPM
G2.5/25000

AD

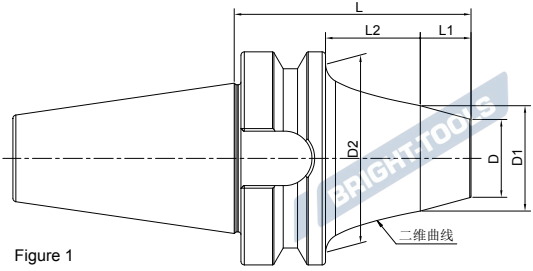

Figure 1

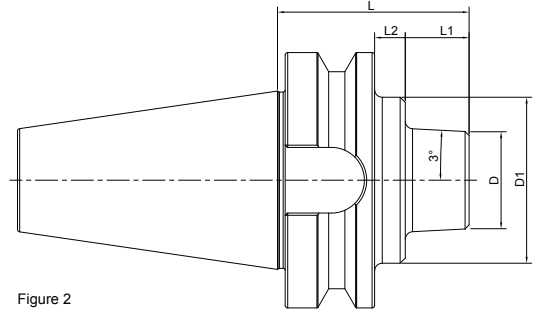

Figure 2

Size	D	D1	D2	L	L1	L2	Figure
BT30-TSF06-35	19	-	34	35	13	-	1
BT30-TSF08-35	23	-	34	35	13	-	1
BT30-TSF12-35	38	-	-	35	13	-	2
BT40-TSF08-40	23	-	53	40	13	-	1
BT40-TSF12-45	38	-	-	45	18	-	2
BT40-TSF12-75	38	-	-	75	48	-	2
BT40-TSF12-135	41	-	-	135	108	-	2
BT50-TSF12-75	38	65	-	75	25	12	2
BT50-TSF12-105	41	66	-	105	55	12	2
BT50-TSF12-135	41	67	-	135	85	12	2



Shrink Chuck Taper 分体热缩本体, 标准型

 A ↗
≤0.003

 RPM
G2.5/25000

AD

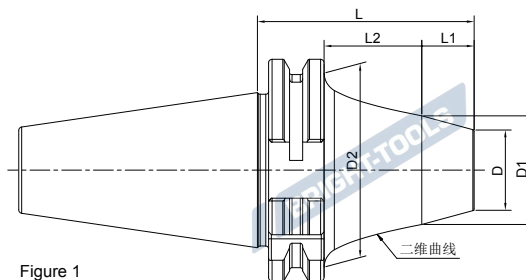

Figure 1

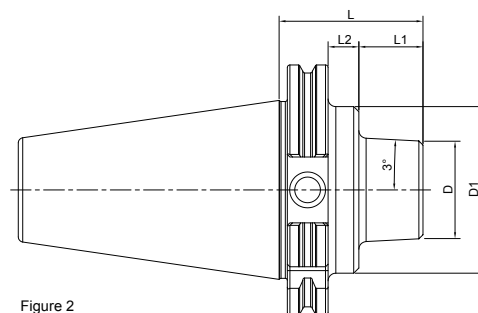

Figure 2

Size	D	D1	D2	L	L1	L2	Figure
SK30-TSF06-35	19	-	34	35	15.9	-	1
SK30-TSF08-35	23	27.5	34	35	15.9	-	1
SK30-TSF12-35	38	-	-	35	15.9	-	2
SK40-TSF08-40	23	31.2	50	40	20.9	-	1
SK40-TSF12-45	38	-	-	45	25.9	-	2
SK40-TSF12-75	38	-	-	75	55.9	-	2
SK40-TSF12-135	38	-	-	135	-	-	-
SK50-TSF12-75	38	65	-	75	43.9	12	2
SK50-TSF12-105	38	65	-	105	-	12	2
SK50-TSF12-135	38	65	-	135	-	12	2

Shrink Chuck Taper
分体热缩本体，标准型

A ↗ ≤0.003	RPM G2.5/25000	AD
---------------	-------------------	----

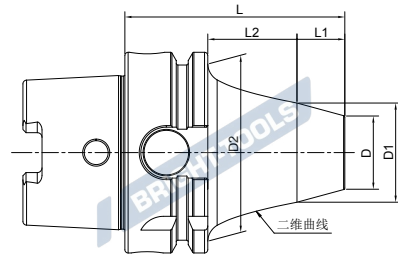

Figure 1

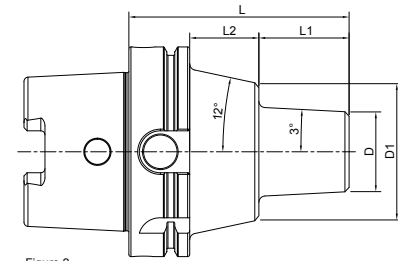

Figure 2

Size	D	D1	D2	L	L1	L2	Figure
HSK50A-TSF06-55	19	24.6	42	55	7	22	1
HSK50A-TSF08-55	23	28.1	42	55	7	22	1
HSK50A-TSF12-75	38	-	-	75	49	-	2
HSK63A-TSF08-55	23	29.5	53	55	7	22	1
HSK63A-TSF12-75	38	-	-	75	49	-	2
HSK63A-TSF12-135	38	-	-	135	109	-	2
HSK100A-TSF12-105	38	65	-	105	43	33	2



Shrink Chuck Taper

分体热缩本体, 标准型

A ↗ ≤0.003	RPM G2.5/25000	 AD
---------------	-------------------	--------

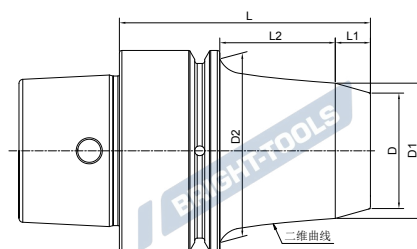

Figure 1

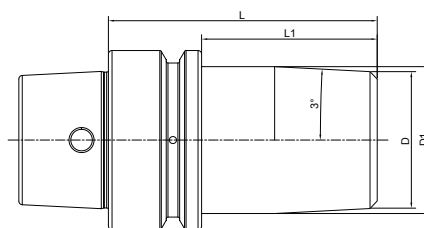

Figure 2

Size	D	D1	D2	L	L1	L2	Figure
HSK32E-TSF06-50	19	26	-	50	7	23	1
HSK40E-TSF06-50	19	23.5	34	50	7	23	1
HSK40E-TSF08-50	23	27	34	50	7	23	1
HSK50E-TSF06-55	19	24.6	42	55	7	22	1
HSK50E-TSF08-55	23	28.1	42	55	7	22	1
HSK50E-TSF12-75	38	-	-	75	49	-	2

BRIGHT-TOOLS

BRIGHT-TOOLS

BRIGHT-TOOLS

BRIGHT-TOOLS

Shrink Chuck Taper
分体热缩本体, 标准型

A ↗ ≤0.003	RPM G2.5/25000	AD
---------------	-------------------	----

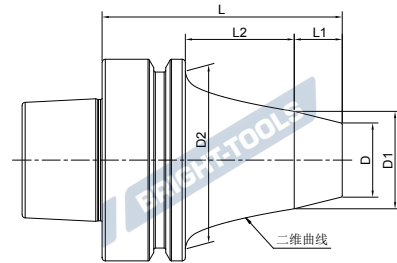

Figure 1

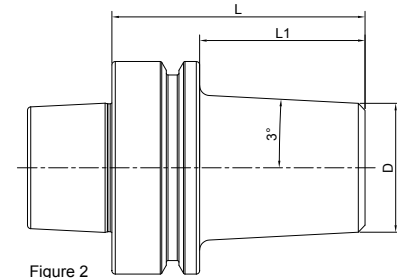

Figure 2

Size	D	D1	D2	L	L1	L2	Figure
HSK63F-TSF08-55	23	29.5	53	55	7	22	1
HSK63F-TSF12-75	38	-	-	75	49	-	2



Shrink Chuck Taper, Coolant

分体热缩本体, 端面出水型



A ↗	RPM	
≤0.003	G2.5/25000	AD

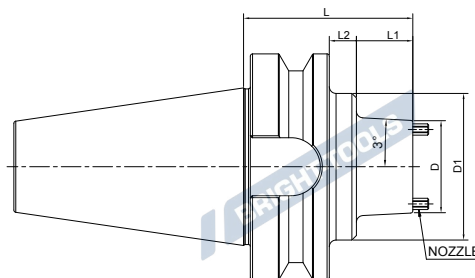

Size	D	D1	L	L1	L2
BT40-TSF12-45K	41	-	45	18	-
BT40-TSF12-75K	41	-	75	48	-
BT40-TSF12-135K	41	-	135	108	-
BT50-TSF12-75K	41	65	75	25	12
BT50-TSF12-105K	41	65	105	55	12
BT50-TSF12-135K	41	65	135	85	12

BRIGHT-TOOLS

BRIGHT-TOOLS

Tool Holder DIN 69871

Shrink Chuck Taper, Coolant

分体热缩本体, 端面出水型



A ↗	RPM	
≤0.003	G2.5/25000	AD

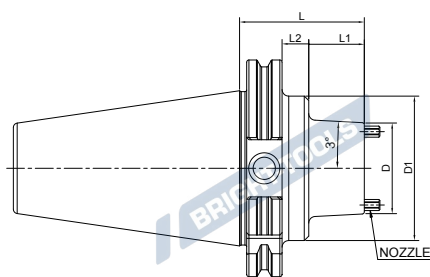

Size	D	D1	L	L1	L2
SK40-TSF12-45K	41	-	45	25.9	-
SK40-TSF12-75K	41	-	75	55.9	-
SK40-TSF12-135K	41	44	135	28.6	87.3
SK50-TSF12-75K	41	65	75	43.9	12
SK50-TSF12-105K	41	65	105	73.9	12
SK50-TSF12-135K	41	65	135	103.9	12

BRIGHT-TOOLS

BRIGHT-TOOLS

Shrink Chuck Taper, Coolant
分体热缩本体，端面出水型

A ↗ ≤0.003	RPM G2.5/25000	AD
---------------	-------------------	----

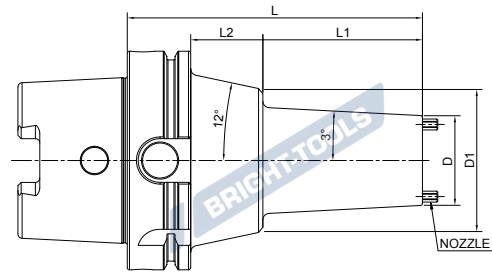

Size	D	D1	L	L1	L2
HSK63A-TSF12-75K	41	-	75	49	-
HSK63A-TSF12-135K	41	-	135	109	-
HSK100A-TSF12-105K	41	65	105	43	33
HSK100A-TSF12-135K	41	65	135	73	33



Shrink Chuck Extension, Slim

分体热缩延长杆, 细长型

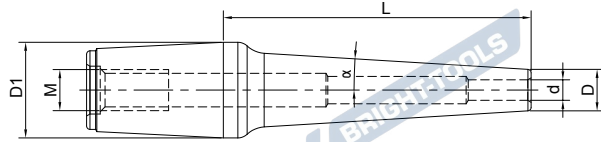

Size	d	D	D1	L	M	α
12-SF3-35S	03	6	26	35	M10	3
12-SF3-55S	03	6	26	55	M10	3
12-SF3-80S	03	6	26	80	M10	3
12-SF3-110S	03	6	26	110	M10	3
12-SF4-35S	04	7	26	35	M10	3
12-SF4-55S	04	7	26	55	M10	3
12-SF4-80S	04	7	26	80	M10	3
12-SF4-110S	04	7	26	110	M10	3
12-SF5-35S	05	8	26	35	M10	3
12-SF5-55S	05	8	26	55	M10	3
12-SF5-80S	05	8	26	80	M10	3
12-SF5-110S	05	8	26	110	M10	3
12-SF6-35S	06	9	26	35	M10	3
12-SF6-55S	06	9	26	55	M10	3
12-SF6-80S	06	9	26	80	M10	3
12-SF6-110S	06	9	26	110	M10	3
12-SF7-35S	07	10	26	35	M10	3
12-SF7-55S	07	10	26	55	M10	3
12-SF7-80S	07	10	26	80	M10	3
12-SF7-110S	07	10	26	110	M10	3
12-SF8-35S	08	11	26	35	M10	3
12-SF8-55S	08	11	26	55	M10	3
12-SF8-80S	08	11	26	80	M10	3
12-SF8-110S	08	11	26	110	M10	3

Shrink Chuck Extension, Slim 分体热缩延长杆, 细长型

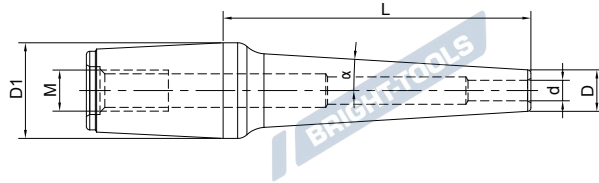

Size	d	D	D1	L	M	α
12-SF9-35S	09	12	26	35	M10	3
12-SF9-55S	09	12	26	55	M10	3
12-SF9-80S	09	12	26	80	M10	3
12-SF9-110S	09	12	26	110	M10	3
12-SF10-35S	10	13	26	35	M10	3
12-SF10-55S	10	13	26	55	M10	3
12-SF10-80S	10	13	26	80	M10	3
12-SF10-110S	10	13	26	110	M10	3
12-SF11-35S	11	14	26	35	M10	3
12-SF11-55S	11	14	26	55	M10	3
12-SF11-80S	11	14	26	80	M10	3
12-SF11-110S	11	14	26	110	M10	3
12-SF12-35S	12	15	26	35	M10	3
12-SF12-55S	12	15	26	55	M10	3
12-SF12-80S	12	15	26	80	M10	3
12-SF12-110S	12	15	26	110	M10	3

Inch

Size	d	D	D1	L	M	α
12-SF1/8"-35S	1/8"	6.175	26	35	M10	3
12-SF1/8"-55S	1/8"	6.175	26	55	M10	3
12-SF1/8"-80S	1/8"	6.175	26	80	M10	3
12-SF1/8"-110S	1/8"	6.175	26	110	M10	3

Shrink Chuck Extension, Standard

分体热缩延长杆, 标准型

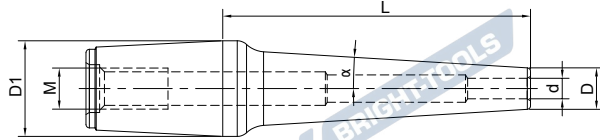

Size	d	D	D1	L	M	α
12-SF3-35	03	7.5	26	35	M10	3
12-SF3-55	03	7.5	26	55	M10	3
12-SF3-80	03	7.5	26	80	M10	3
12-SF4-35	04	10	26	35	M10	3
12-SF4-55	04	10	26	55	M10	3
12-SF4-80	04	10	26	80	M10	3
12-SF6-35	06	12	26	35	M10	3
12-SF6-55	06	12	26	55	M10	3
12-SF6-80	06	12	26	80	M10	3
12-SF8-35	08	14	26	35	M10	3
12-SF8-55	08	14	26	55	M10	3
12-SF8-80	08	14	26	80	M10	3
12-SF10-35	10	16	26	35	M10	3
12-SF10-55	10	16	26	55	M10	3
12-SF10-80	10	16	26	80	M10	3
12-SF12-35	12	20	26	35	M10	3
12-SF12-55	12	20	26	55	M10	3
12-SF12-80	12	20	26	80	M10	3

Shrink Chuck Extension, Coolant

分体热缩延长杆, 端面出水型

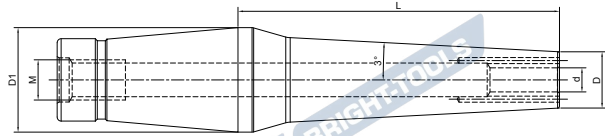

Size	d	D	D1	L	M
12-SF3-35K	03	9.5	26	35	M10
12-SF3-55K	03	9.5	26	55	M10
12-SF3-80K	03	9.5	26	80	M10
12-SF4-35K	04	12	26	35	M10
12-SF4-55K	04	12	26	55	M10
12-SF4-80K	04	12	26	80	M10
12-SF6-35K	06	14	26	35	M10
12-SF6-55K	06	14	26	55	M10
12-SF6-80K	06	14	26	80	M10
12-SF8-35K	08	16	26	35	M10
12-SF8-55K	08	16	26	55	M10
12-SF8-80K	08	16	26	80	M10
12-SF10-35K	10	18	26	35	M10
12-SF10-55K	10	18	26	55	M10
12-SF10-80K	10	18	26	80	M10
12-SF12-35K	12	20	26	35	M10
12-SF12-55K	12	20	26	55	M10
12-SF12-80K	12	20	26	80	M10

Shrink Chuck Set

热缩刀柄套装

A ↗
≤0.003

RPM
G2.5/25000

AD



Size	Tool Holder Size	Extension Size	Extension Quantity
BT40-TSF08-40-4 pcs	BT40-TSF08-40	8-SF3/4/6/8-45S	4
BT40-TSF08-70-4 pcs	BT40-TSF08-70	8-SF3/4/6/8-45S	4
BT40-TSF12-45-6 pcs	BT40-TSF12-45	12-SF3/4/6/8/10/12-80S	6
BT40-TSF12-75-6 pcs	BT40-TSF12-75	12-SF3/4/6/8/10/12-80S	6
SK40-TSF08-40-4 pcs	SK40-TSF08-40	8-SF3/4/6/8-45S	4
SK40-TSF08-70-4 pcs	SK40-TSF08-70	8-SF3/4/6/8-45S	4
SK40-TSF12-45-6 pcs	SK40-TSF12-45	12-SF3/4/6/8/10/12-80S	6
SK40-TSF12-75-6 pcs	SK40-TSF12-75	12-SF3/4/6/8/10/12-80S	6
HSK63A-TSF08-55-4 pcs	HSK63A-TSF08-55	8-SF3/4/6/8-45S	4
HSK63A-TSF08-75-4 pcs	HSK63A-TSF08-75	8-SF3/4/6/8-45S	4
HSK63A-TSF12-75-6 pcs	HSK63A-TSF12-75	12-SF3/4/6/8/10/12-80S	6
HSK63F-TSF08-55-4 pcs	HSK63F-TSF08-55	8-SF3/4/6/8-45S	4
HSK63F-TSF08-75-4 pcs	HSK63F-TSF08-75	8-SF3/4/6/8-45S	4
HSK63F-TSF12-75-6 pcs	HSK63F-TSF12-75	12-SF3/4/6/8/10/12-80S	6

BRIGHT-TOOLS

BRIGHT-TOOLS

TOOL HOLDERS

**STAINLESS
SHRINK**

BRIGHT-TOOLS

BRIGHT-TOOLS

BRIGHT-TOOLS

BRIGHT-TOOLS

BRIGHT-TOOLS

BRIGHT-TOOLS

Shrink Chuck, 3°, Slim, Form A
热缩刀柄 3 度, 薄壁 A 型

A ↗ ≤0.003	RPM G2.5/25000	AD
---------------	-------------------	----

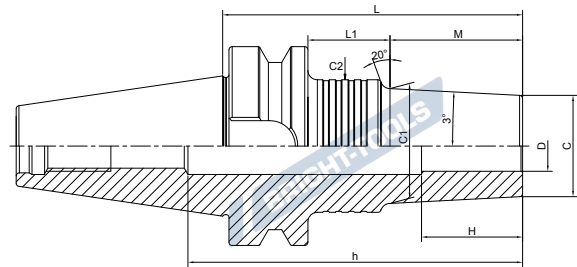

Size	D	C	L	M	L1	C1	C2	H	h
BT30-SFSA03-60-M22	03	6	60	22	16	8.3	20	9	80
BT30-SFSA03-75-M22	03	6	75	22	31	8.3	25	9	99
BT30-SFSA03-95-M42	03	6	95	42	31	10.4	25	9	119
BT30-SFSA03-120-M67	03	6	120	67	31	13	25	9	144
BT30-SFSA04-75-M22	04	7	75	22	31	9.3	25	12	99
BT30-SFSA04-95-M42	04	7	95	42	31	11.4	25	12	119
BT30-SFSA04-120-M67	04	7	120	67	31	14	25	12	144
BT30-SFSA06-75-M22	06	9	75	22	31	11.3	25	18	99
BT30-SFSA06-95-M42	06	9	95	42	31	13.4	25	18	119
BT30-SFSA06-120-M67	06	9	120	67	31	16	25	18	144
BT30-SFSA1/8"-75-M22	1/8"	6.175	75	22	31	8.5	25	9	99
BT30-SFSA1/8"-95-M42	1/8"	6.175	95	42	31	10.6	25	9	119



Shrink Chuck, 3°, Slim, Form A
热缩刀柄 3 度, 薄壁 A 型

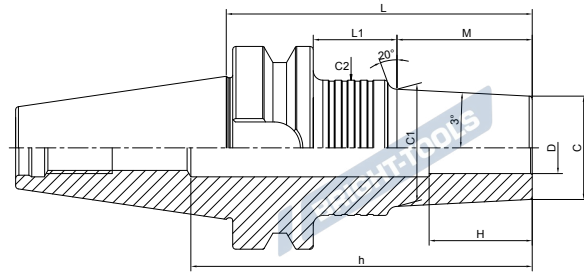

A ↗	RPM	
≤0.003	G2.5/25000	AD



Size	D	C	L	M	L1	C1	C2	H	h
BT40-SFSA03-95-M42	03	6	95	42	26	10.4	25	9	130
BT40-SFSA03-120-M67	03	6	120	67	26	13	25	9	155
BT40-SFSA03-125-M42	03	6	125	42	56	10.4	25	9	160
BT40-SFSA03-150-M67	03	6	150	67	56	13	25	9	185
BT40-SFSA03-150-M97	03	6	150	97	26	16.2	25	9	185
BT40-SFSA03-180-M97	03	6	180	97	56	16.2	26	9	215
BT40-SFSA04-95-M42	04	7	95	42	26	11.4	25	12	130
BT40-SFSA04-120-M67	04	7	120	67	26	14	25	12	155
BT40-SFSA04-125-M42	04	7	125	42	56	11.4	25	12	160
BT40-SFSA04-150-M67	04	7	150	67	56	14	25	12	185
BT40-SFSA04-150-M97	04	7	150	97	26	17.2	25	12	185
BT40-SFSA04-180-M97	04	7	180	97	56	17.2	25	12	215
BT40-SFSA06-95-M42	06	9	95	42	26	13.4	25	18	130
BT40-SFSA06-120-M67	06	9	120	67	26	16	26	18	155
BT40-SFSA06-125-M42	06	9	125	42	56	13.4	25	18	160
BT40-SFSA06-150-M67	06	9	150	67	56	16	25	18	185
BT40-SFSA06-150-M97	06	9	150	97	26	19.2	32	18	185
BT40-SFSA06-180-M97	06	9	180	97	56	19.2	32	18	215
BT40-SFSA08-95-M42	08	11	95	42	26	15.4	25	24	130
BT40-SFSA08-120-M67	08	11	120	67	26	18	32	24	155
BT40-SFSA08-125-M42	08	11	125	42	56	15.4	36	24	160
BT40-SFSA08-150-M67	08	11	150	67	56	18	32	24	185
BT40-SFSA08-150-M97	08	11	150	97	26	21.2	32	24	185
BT40-SFSA08-180-M97	08	11	180	97	56	21.2	32	24	215
BT40-SFSA10-95-M42	10	13	95	42	26	17.4	25	30	130
BT40-SFSA10-120-M67	10	13	120	67	26	20	32	30	155
BT40-SFSA10-125-M42	10	13	125	42	56	17.4	25	30	160
BT40-SFSA10-150-M67	10	13	150	67	56	20	32	30	185
BT40-SFSA10-150-M97	10	13	150	97	26	23.2	32	30	185
BT40-SFSA10-180-M97	10	13	180	97	56	23.2	36	30	215

Shrink Chuck, 3°, Slim, Form A
热缩刀柄 3 度, 薄壁 A 型

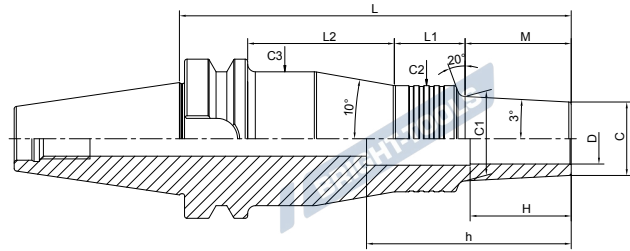
A ↗ ≤0.003	RPM G2.5/25000	AD
---------------	-------------------	----



Size	D	C	L	M	L1	L2	C1	C2	C3	H	h
BT40-SFSA03-155-M42	03	6	155	42	33	53	10.4	26	40	9	190
BT40-SFSA03-180-M67	03	6	180	67	33	53	13	26	40	9	215
BT40-SFSA03-210-M97	03	6	210	97	33	53	16.2	25	39	9	245
BT40-SFSA04-155-M42	04	7	155	42	33	53	11.4	25	39	12	190
BT40-SFSA04-180-M67	04	7	180	67	33	53	14	25	39	12	215
BT40-SFSA04-210-M97	04	7	210	97	33	53	17.2	25	39	12	245
BT40-SFSA06-155-M42	06	9	155	42	33	53	13.4	25	39	18	190
BT40-SFSA06-180-M67	06	9	180	67	33	53	16	25	39	18	215
BT40-SFSA06-210-M97	06	9	210	97	30	56	19.2	32	46	18	245
BT40-SFSA08-155-M42	08	11	155	42	33	53	15.4	25	39	24	190
BT40-SFSA08-180-M67	08	11	180	67	30	56	18	32	46	24	215
BT40-SFSA08-210-M97	08	11	210	97	28	58	21.2	36	50	24	245
BT40-SFSA10-155-M42	10	13	155	42	30	53	17.4	25	39	30	190
BT40-SFSA10-180-M67	10	13	180	67	28	58	20	36	50	30	215
BT40-SFSA10-210-M97	10	13	210	97	30	56	23.2	32	46	30	245
BT40-SFSA12-155-M42	12	15	155	42	30	56	19.4	32	46	30	190
BT40-SFSA12-180-M67	12	15	180	67	56	56	22	32	46	30	215
BT40-SFSA12-210-M97	12	15	210	97	30	56	25.2	32	46	30	245



Shrink Chuck, 3°, Slim, Form A 热缩刀柄 3 度, 薄壁 A 型

A ↗	RPM	
≤0.003	G2.5/25000	AD

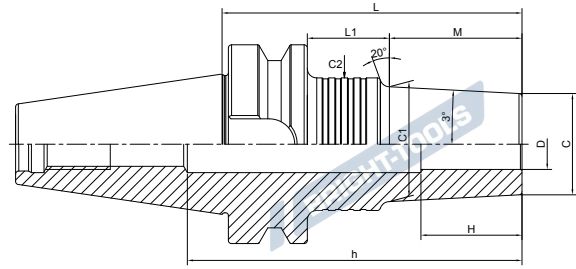

Size	D	C	L	M	L1	C1	C2	H	h
BT50-SFSA03-110-M42	03	6	110	42	30	10.4	26	9	165
BT50-SFSA03-135-M67	03	6	135	67	30	13	26	9	190
BT50-SFSA03-140-M42	03	6	140	42	60	10.4	25	9	195
BT50-SFSA03-165-M67	03	6	165	67	60	13	25	9	220
BT50-SFSA03-165-M97	03	6	165	97	30	16.2	26	9	220
BT50-SFSA03-195-M97	03	6	195	97	60	16.2	26	9	250
BT50-SFSA04-110-M42	04	7	110	42	30	11.4	25	12	165
BT50-SFSA04-135-M67	04	7	135	67	30	14	25	12	190
BT50-SFSA04-140-M42	04	7	140	42	60	11.4	25	12	195
BT50-SFSA04-165-M67	04	7	165	67	60	14	25	12	220
BT50-SFSA04-165-M97	04	7	165	97	30	17.2	25	12	220
BT50-SFSA04-195-M97	04	7	195	97	60	17.2	25	12	250
BT50-SFSA06-110-M42	06	9	110	42	30	13.4	25	18	165
BT50-SFSA06-135-M67	06	9	135	67	30	16	25	18	190
BT50-SFSA06-140-M42	06	9	140	42	60	13.4	25	18	195
BT50-SFSA06-165-M67	06	9	165	67	60	16	25	18	220
BT50-SFSA06-165-M97	06	9	165	97	30	19.2	32	18	220
BT50-SFSA06-195-M97	06	9	195	97	60	19.2	32	18	250
BT50-SFSA08-110-M42	08	11	110	42	30	15.4	25	24	165
BT50-SFSA08-135-M67	08	11	135	67	30	18	32	24	190
BT50-SFSA08-140-M42	08	11	140	42	60	15.4	25	24	195
BT50-SFSA08-165-M67	08	11	165	67	60	18	32	24	220
BT50-SFSA08-165-M97	08	11	165	97	30	21.2	32	24	220
BT50-SFSA08-195-M97	08	11	195	97	60	21.2	32	24	250

Shrink Chuck, 3°, Slim, Form A
热缩刀柄 3 度, 薄壁 A 型

A ↗ ≤0.003	RPM G2.5/25000	AD
----------------------	--------------------------	-----------

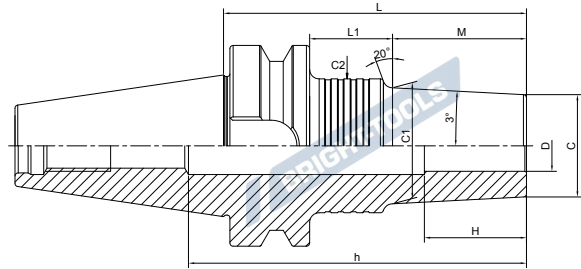

Size	D	C	L	M	L1	C1	C2	H	h
BT50-SFSA10-110-M42	10	13	110	42	30	17.4	25	30	165
BT50-SFSA10-135-M67	10	13	135	67	30	20	32	30	190
BT50-SFSA10-140-M42	10	13	140	42	60	17.4	25	30	195
BT50-SFSA10-165-M67	10	13	165	67	60	20	32	30	220
BT50-SFSA10-165-M97	10	13	165	97	30	23.2	32	30	220
BT50-SFSA10-195-M97	10	13	195	97	60	23.2	32	30	250
BT50-SFSA12-110-M42	12	15	110	42	30	19.4	32	30	165
BT50-SFSA12-135-M67	12	15	135	67	30	22	32	30	190
BT50-SFSA12-140-M42	12	15	140	42	60	19.4	32	30	195
BT50-SFSA12-165-M67	12	15	165	67	60	22	32	30	220
BT50-SFSA12-165-M97	12	15	165	97	30	25.2	32	30	220
BT50-SFSA12-195-M97	12	15	195	97	60	25.2	32	30	250



Shrink Chuck, 3°, Slim, Form A
热缩刀柄 3 度, 薄壁 A 型

A ↗ ≤0.003	RPM G2.5/25000	AD
---------------	-------------------	----

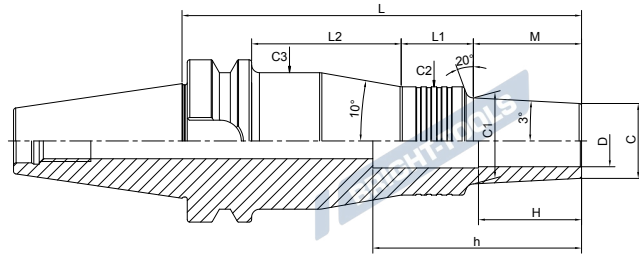

Size	D	C	L	M	L1	L2	C1	C2	C3	H	h
BT50-SFSA03-170-M42	03	6	170	42	33	57	10.4	26	40	9	225
BT50-SFSA03-195-M67	03	6	195	67	33	57	13	26	40	9	250
BT50-SFSA03-225-M97	03	6	225	97	33	57	16.2	26	40	9	280
BT50-SFSA04-170-M42	04	7	170	42	33	57	11.4	25	39	12	225
BT50-SFSA04-195-M67	04	7	195	67	33	57	14	25	39	12	250
BT50-SFSA04-225-M97	04	7	225	97	33	57	17.2	25	39	12	280
BT50-SFSA06-170-M42	06	9	170	42	33	57	13.4	26	40	18	225
BT50-SFSA06-195-M67	06	9	195	67	33	57	16	25	39	18	250
BT50-SFSA06-225-M97	06	9	225	97	30	60	19.2	32	46	18	280
BT50-SFSA08-170-M42	08	11	170	42	33	57	15.4	25	39	24	225
BT50-SFSA08-195-M67	08	11	195	67	28	62	18	36	50	24	250
BT50-SFSA08-225-M97	08	11	225	97	28	62	21.2	36	50	24	280
BT50-SFSA10-170-M42	10	13	170	42	33	57	17.4	25	39	30	225
BT50-SFSA10-195-M67	10	13	195	67	28	62	20	36	50	30	250
BT50-SFSA10-225-M97	10	13	225	97	30	60	23.2	32	46	30	280
BT50-SFSA12-170-M42	12	15	170	42	30	60	19.4	32	46	30	225
BT50-SFSA12-195-M67	12	15	195	67	30	60	22	32	46	30	250
BT50-SFSA12-225-M97	12	15	225	97	30	60	25.2	32	46	30	280

Shrink Chuck, 3°, Slim, Form A
热缩刀柄 3 度, 薄壁 A 型

A ↗ ≤0.003	RPM G2.5/25000	AD
----------------------	--------------------------	-----------

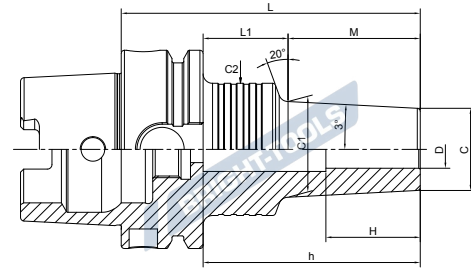

Size	D	C	L	M	L1	C1	C2	H	h
HSK40A-SFSA03-60-M22	03	6	60	22	18	8.3	20	9	44
HSK40A-SFSA03-65-M22	03	6	65	22	23	8.3	25	9	44
HSK40A-SFSA03-85-M42	03	6	85	42	23	10.4	25	9	64
HSK40A-SFSA03-100-M42	03	6	100	42	38	10.4	25	9	78
HSK40A-SFSA04-60-M22	04	7	60	22	18	9.3	20	12	44
HSK40A-SFSA04-65-M22	04	7	65	22	23	9.3	25	12	44
HSK40A-SFSA04-85-M42	04	7	85	42	23	11.4	25	12	64
HSK40A-SFSA04-100-M42	04	7	100	42	38	11.4	25	12	78
HSK40A-SFSA06-65-M22	06	9	65	22	23	11.3	25	18	44
HSK40A-SFSA06-85-M42	06	9	85	42	23	13.4	25	18	64
HSK40A-SFSA06-100-M42	06	9	100	42	38	13.4	25	18	78
HSK40A-SFSA08-65-M22	08	11	65	22	23	13.3	25	24	44
HSK40A-SFSA08-85-M42	08	11	85	42	23	15.4	25	24	64
HSK40A-SFSA08-100-M42	08	11	100	42	38	15.4	25	24	78
HSK40A-SFSA10-65-M22	10	13	65	22	23	15.3	25	30	44
HSK40A-SFSA10-85-M42	10	13	85	42	23	17.4	25	30	64
HSK40A-SFSA10-100-M42	10	13	100	42	38	17.4	25	30	78
HSK40A-SFSA12-65-M22	12	15	65	22	23	17.3	25	30	44
HSK40A-SFSA12-90-M42	12	15	90	42	28	19.4	32	30	68
HSK50A-SFSA03-95-M42	03	6	95	42	27	10.4	25	9	71
HSK50A-SFSA03-125-M42	03	6	125	42	57	10.4	25	9	101
HSK50A-SFSA04-95-M42	04	7	95	42	27	11.4	25	12	71
HSK50A-SFSA04-125-M42	04	7	125	42	57	11.4	25	12	101
HSK50A-SFSA06-95-M42	06	9	95	42	27	13.4	25	18	71
HSK50A-SFSA06-125-M42	06	9	125	42	57	13.4	25	18	101
HSK50A-SFSA08-95-M42	08	11	95	42	27	15.4	25	24	71
HSK50A-SFSA08-125-M42	08	11	125	42	57	15.4	25	24	101
HSK50A-SFSA10-95-M42	10	13	95	42	27	17.4	25	30	71
HSK50A-SFSA10-125-M42	10	13	125	42	57	17.4	25	30	101



Shrink Chuck, 3°, Slim, Form A
热缩刀柄 3 度, 薄壁 A 型

A ↗ ≤0.003	RPM G2.5/25000	AD
---------------	-------------------	----

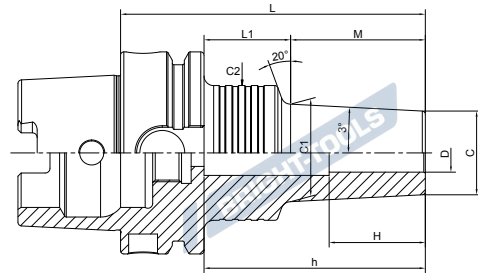

Size	D	C	L	M	L1	C1	C2	H	h
HSK63A-SFSA03-95-M42	03	6	95	42	27	10.4	25	9	70
HSK63A-SFSA03-120-M67	03	6	120	67	27	13	25	9	95
HSK63A-SFSA03-125-M42	03	6	125	42	57	10.4	26	9	100
HSK63A-SFSA03-150-M67	03	6	150	67	57	13	25	9	125
HSK63A-SFSA03-150-M97	03	6	150	97	27	16.2	25	9	125
HSK63A-SFSA03-180-M97	03	6	180	97	57	16.2	25	9	155
HSK63A-SFSA04-95-M42	04	7	95	42	27	11.4	25	12	70
HSK63A-SFSA04-120-M67	04	7	120	67	27	14	25	12	95
HSK63A-SFSA04-125-M42	04	7	125	42	57	11.4	25	12	100
HSK63A-SFSA04-150-M67	04	7	150	67	57	14	25	12	125
HSK63A-SFSA04-150-M97	04	7	150	97	27	17.2	25	12	125
HSK63A-SFSA04-180-M97	04	7	180	97	57	17.2	25	12	155
HSK63A-SFSA06-95-M42	06	9	95	42	27	13.4	25	18	70
HSK63A-SFSA06-120-M67	06	9	120	67	27	16	25	18	95
HSK63A-SFSA06-125-M42	06	9	125	42	57	13.4	25	18	100
HSK63A-SFSA06-150-M67	06	9	150	67	57	16	25	18	125
HSK63A-SFSA06-150-M97	06	9	150	97	27	19.2	32	18	124
HSK63A-SFSA06-180-M97	06	9	180	97	57	19.2	32	18	154
HSK63A-SFSA08-95-M42	08	11	95	42	27	15.4	25	24	70
HSK63A-SFSA08-120-M67	08	11	120	67	27	18	32	24	94
HSK63A-SFSA08-125-M42	08	11	125	42	57	15.4	25	24	100
HSK63A-SFSA08-150-M67	08	11	150	67	57	18	32	24	124
HSK63A-SFSA08-150-M97	08	11	150	97	27	21.2	32	24	124
HSK63A-SFSA08-180-M97	08	11	180	97	57	21.2	32	24	154

Shrink Chuck, 3°, Slim, Form A

热缩刀柄 3 度, 薄壁 A 型

A ↗ ≤0.003	RPM G2.5/25000	AD
----------------------	--------------------------	-----------

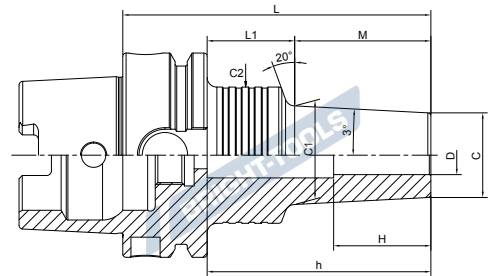

Size	D	C	L	M	L1	C1	C2	H	h
HSK63A-SFSA10-95-M42	10	13	95	42	27	17.4	25	30	70
HSK63A-SFSA10-120-M67	10	13	120	67	27	20	32	30	94
HSK63A-SFSA10-125-M42	10	13	125	42	57	17.4	25	30	100
HSK63A-SFSA10-150-M67	10	13	150	67	57	20	32	30	124
HSK63A-SFSA10-150-M97	10	13	150	97	27	23.2	32	30	124
HSK63A-SFSA10-180-M97	10	13	180	97	57	23.2	36	30	153
HSK63A-SFSA12-95-M42	12	15	95	42	27	19.4	32	30	69
HSK63A-SFSA12-120-M67	12	15	120	67	27	22	32	30	94
HSK63A-SFSA12-125-M42	12	15	125	42	57	19.4	32	30	99
HSK63A-SFSA12-150-M67	12	15	150	67	57	22	32	30	124
HSK63A-SFSA12-150-M97	12	15	150	97	27	25.2	32	30	124
HSK63A-SFSA12-180-M97	12	15	180	97	57	25.2	32	30	154



Shrink Chuck, 3°, Slim, Form A
热缩刀柄 3 度, 薄壁 A 型

 A ↗
 ≤0.003

 RPM
 G2.5/25000

AD

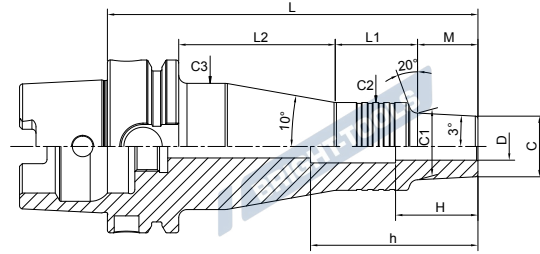

Size	D	C	L	M	L1	L2	C1	C2	C3	H	h
HSK63A-SFSA03-155-M42	03	6	155	42	33	54	10.4	26	40	9	130
HSK63A-SFSA03-180-M67	03	6	180	67	33	54	13	25	39	9	155
HSK63A-SFSA03-210-M97	03	6	210	97	33	54	16.2	25	39	9	185
HSK63A-SFSA04-155-M42	04	7	155	42	33	54	11.4	25	39	12	130
HSK63A-SFSA04-180-M67	04	7	180	67	33	54	14	26	39	12	155
HSK63A-SFSA04-210-M97	04	7	210	97	33	54	17.2	25	39	12	185
HSK63A-SFSA06-155-M42	06	9	155	42	33	54	13.4	25	39	18	130
HSK63A-SFSA06-180-M67	06	9	180	67	33	54	16	25	39	18	155
HSK63A-SFSA06-210-M97	06	9	210	97	30	57	19.2	32	46	18	184
HSK63A-SFSA08-155-M42	08	11	155	42	33	54	15.4	25	39	24	130
HSK63A-SFSA08-180-M67	08	11	180	67	30	57	18	32	46	24	154
HSK63A-SFSA08-210-M97	08	11	210	97	30	57	21.2	32	46	24	184
HSK63A-SFSA10-155-M42	10	13	155	42	33	54	17.4	25	39	30	130
HSK63A-SFSA10-180-M67	10	13	180	67	30	57	20	32	46	30	154
HSK63A-SFSA10-210-M97	10	13	210	97	30	57	23.2	32	46	30	184
HSK63A-SFSA12-155-M42	12	15	155	42	30	57	19.4	32	46	30	129
HSK63A-SFSA12-180-M67	12	15	180	67	30	57	22	32	46	30	154
HSK63A-SFSA12-210-M97	12	15	210	97	30	57	25.2	32	46	30	184

Shrink Chuck, 3°, Slim, Form A
热缩刀柄 3 度, 薄壁 A 型

A ↗ ≤0.003	RPM G2.5/25000	AD
----------------------	--------------------------	-----------

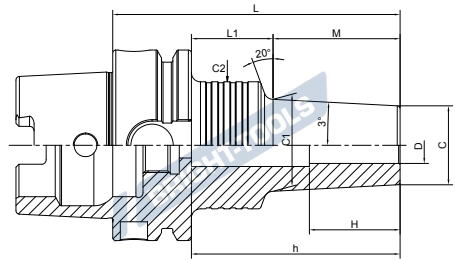

Size	D	C	L	M	L1	C1	C2	H	h
HSK100A-SFSA03-110-M42	03	6	110	42	39	10.4	26	9	80
HSK100A-SFSA03-135-M67	03	6	135	67	39	13	26	9	105
HSK100A-SFSA03-140-M42	03	6	140	42	69	10.4	26	9	110
HSK100A-SFSA03-165-M67	03	6	165	67	69	13	25	9	136
HSK100A-SFSA03-165-M97	03	6	165	97	39	16.2	26	9	135
HSK100A-SFSA03-195-M97	03	6	195	97	69	16.2	25	9	166
HSK100A-SFSA04-110-M42	04	7	110	42	39	11.4	25	12	81
HSK100A-SFSA04-135-M67	04	7	135	67	39	14	25	12	106
HSK100A-SFSA04-140-M42	04	7	140	42	69	11.4	25	12	111
HSK100A-SFSA04-165-M67	04	7	165	67	69	14	25	12	136
HSK100A-SFSA04-165-M97	04	7	165	97	39	17.2	26	12	135
HSK100A-SFSA04-195-M97	04	7	195	97	69	17.2	25	12	166
HSK100A-SFSA06-110-M42	06	9	110	42	39	13.4	25	18	81
HSK100A-SFSA06-135-M67	06	9	135	67	39	16	25	18	106
HSK100A-SFSA06-140-M42	06	9	140	42	69	13.4	25	18	111
HSK100A-SFSA06-165-M67	06	9	165	67	69	16	25	18	136
HSK100A-SFSA06-165-M97	06	9	165	97	39	19.2	32	18	135
HSK100A-SFSA06-195-M97	06	9	195	97	69	19.2	32	18	166

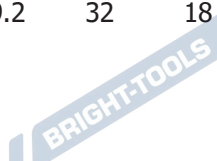

Shrink Chuck, 3°, Slim, Form A
热缩刀柄 3 度, 薄壁 A 型

A ↗ ≤0.003	RPM G2.5/25000	AD
---------------	-------------------	----

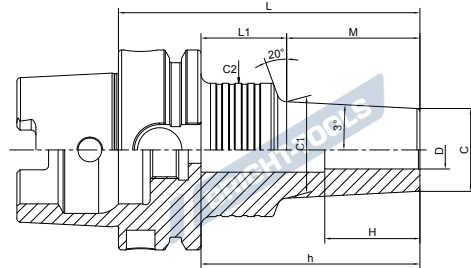

Size	D	C	L	M	L1	C1	C2	H	h
HSK100A-SFSA08-110-M42	08	11	110	42	39	15.4	36	24	80
HSK100A-SFSA08-135-M67	08	11	135	67	39	18	32	24	106
HSK100A-SFSA08-140-M42	08	11	140	42	69	15.4	36	24	110
HSK100A-SFSA08-165-M67	08	11	165	67	69	18	36	24	135
HSK100A-SFSA08-165-M97	08	11	165	97	39	21.2	32	24	136
HSK100A-SFSA08-195-M97	08	11	195	97	69	21.2	32	24	166
HSK100A-SFSA10-110-M42	10	13	110	42	39	17.4	25	30	81
HSK100A-SFSA10-135-M67	10	13	135	67	39	20	32	30	106
HSK100A-SFSA10-140-M42	10	13	140	42	69	17.4	25	30	111
HSK100A-SFSA10-165-M67	10	13	165	67	69	20	36	30	135
HSK100A-SFSA10-165-M97	10	13	165	97	39	23.2	32	30	136
HSK100A-SFSA10-195-M97	10	13	195	97	69	23.2	36	30	165
HSK100A-SFSA12-110-M42	12	15	110	42	39	19.4	32	30	79
HSK100A-SFSA12-135-M67	12	15	135	67	39	22	32	30	104
HSK100A-SFSA12-140-M42	12	15	140	42	69	19.4	32	30	109
HSK100A-SFSA12-165-M67	12	15	165	67	69	22	32	30	134
HSK100A-SFSA12-165-M97	12	15	165	97	39	25.2	32	30	134
HSK100A-SFSA12-195-M97	12	15	195	97	69	25.2	36	30	160

Shrink Chuck, 3°, Slim, Form A

热缩刀柄 3 度, 薄壁 A 型

A ↗ ≤0.003	RPM G2.5/25000	AD
---------------	-------------------	----

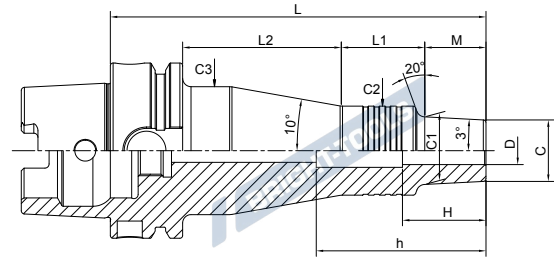

Size	D	C	L	M	L1	L2	C1	C2	C3	H	h
HSK100A-SFSA03-170-M42	03	6	170	42	33	66	10.4	26	40	9	140
HSK100A-SFSA03-195-M67	03	6	195	67	33	66	13	26	40	9	165
HSK100A-SFSA03-225-M97	03	6	225	97	33	66	16.2	26	40	9	195
HSK100A-SFSA04-170-M42	04	7	170	42	33	66	11.4	26	40	12	140
HSK100A-SFSA04-195-M67	04	7	195	67	33	66	14	25	39	12	166
HSK100A-SFSA04-225-M97	04	7	225	97	33	66	17.2	25	39	12	196
HSK100A-SFSA06-170-M42	06	9	170	42	33	66	13.4	25	39	18	141
HSK100A-SFSA06-195-M67	06	9	195	67	33	66	16	26	39	18	166
HSK100A-SFSA06-225-M97	06	9	225	97	30	69	19.2	32	46	18	196
HSK100A-SFSA08-170-M42	08	11	170	42	28	71	15.4	36	50	24	140
HSK100A-SFSA08-195-M67	08	11	195	67	30	69	18	32	46	24	166
HSK100A-SFSA08-225-M97	08	11	225	97	28	71	21.2	36	50	24	195
HSK100A-SFSA10-170-M42	10	13	170	42	28	71	17.4	36	50	30	140
HSK100A-SFSA10-195-M67	10	13	195	67	28	71	20	36	50	30	165
HSK100A-SFSA10-225-M97	10	13	225	97	30	69	23.2	32	46	30	196
HSK100A-SFSA12-170-M42	12	15	170	42	28	71	19.4	36	50	30	135
HSK100A-SFSA12-195-M67	12	15	195	67	30	69	22	32	46	30	164
HSK100A-SFSA12-225-M97	12	15	225	97	30	69	25.2	32	46	30	194



Shrink Chuck, 3°, Slim, Form A
热缩刀柄 3 度, 薄壁 A 型

 A ↗
 ≤0.003

 RPM
 G2.5/25000

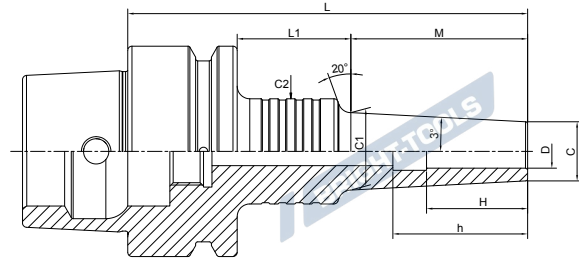
 AD

Size	D	C	L	M	L1	C1	C2	H	h
HSK25E-SFSA03-35	03	6	35	17	8	7.8	18	9	29
HSK25E-SFSA03-50	03	6	50	32	8	9.4	18	9	44
HSK25E-SFSA04-35	04	7	35	17	8	8.8	18	12	29
HSK25E-SFSA04-50	04	7	50	32	8	10.4	18	12	44
HSK25E-SFSA5-35	05	8	35	17	8	9.8	18	15	26
HSK25E-SFSA06-35	06	9	35	17	8	10.8	18	18	26
HSK25E-SFSA06-50	06	9	50	32	8	12.4	18	18	39
HSK25E-SFSA1/8"-35	1/8"	6.175	35	17	8	8	18	9	29
HSK25E-SFSA1/8"-50	1/8"	6.175	50	32	8	9.6	18	9	44
HSK32E-SFSA03-50-M22	03	6	50	22	8	8.3	20	9	42
HSK32E-SFSA03-70-M42	03	6	70	42	8	10.4	20	9	62
HSK32E-SFSA03-85-M42	03	6	85	42	23	10.4	25	9	69
HSK32E-SFSA04-50-M22	04	7	50	22	8	9.3	20	12	42
HSK32E-SFSA04-70-M42	04	7	70	42	8	11.4	20	12	62
HSK32E-SFSA04-85-M42	04	7	85	42	23	11.4	25	12	77
HSK32E-SFSA06-70-M42	06	9	70	42	8	13.4	20	18	62
HSK32E-SFSA1/8"-50-M22	1/8"	6.175	50	22	8	9	20	9	42

Shrink Chuck, 3°, Slim, Form A
热缩刀柄 3 度, 薄壁 A 型

A ↗ ≤0.003	RPM G2.5/25000	AD
---------------	-------------------	----

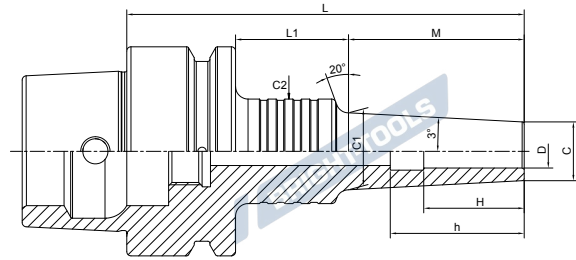

Size	D	C	L	M	L1	C1	C2	H	h
HSK40E-SFSA03-50-M22	03	6	50	22	8	8.3	20	9	42
HSK40E-SFSA03-70-M42	03	6	70	42	8	10.4	20	9	62
HSK40E-SFSA03-85-M42	03	6	85	42	23	10.4	25	9	69
HSK40E-SFSA03-110-M67	03	6	110	67	23	13.0	25	9	94
HSK40E-SFSA04-50-M22	04	7	50	22	8	9.3	20	12	42
HSK40E-SFSA04-70-M42	04	7	70	42	8	11.4	20	12	62
HSK40E-SFSA04-85-M42	04	7	85	42	23	11	25	12	74
HSK40E-SFSA04-110-M67	04	7	110	67	23	14.0	25	12	99
HSK40E-SFSA06-50-M22	06	9	50	22	8	11.3	20	18	39
HSK40E-SFSA06-70-M42	06	9	70	42	8	13.4	20	18	54
HSK40E-SFSA06-85-M42	06	9	85	42	23	13.4	25	18	69
HSK40E-SFSA06-110-M67	06	9	110	67	23	16	25	18	94
HSK40E-SFSA08-60-M22	08	11	60	22	18	13.3	26	24	49
HSK40E-SFSA08-80-M42	08	11	80	42	18	15.4	26	24	64
HSK40E-SFSA08-100-M42	08	11	100	42	38	15.4	25	24	84
HSK40E-SFSA10-60-M22	10	13	60	22	18	15.3	26	30	49
HSK40E-SFSA10-80-M42	10	13	80	42	18	17.4	26	30	64
HSK40E-SFSA10-100-M42	10	13	100	42	38	17.4	25	30	89
HSK40E-SFSA1/8"-50-M22	1/8"	6.175	50	22	8	8.5	20	9	42



Shrink Chuck, 3°, Slim, Form A
热缩刀柄 3 度, 薄壁 A 型

A ↗ ≤0.003	RPM G2.5/25000	AD
----------------------	-------------------	----

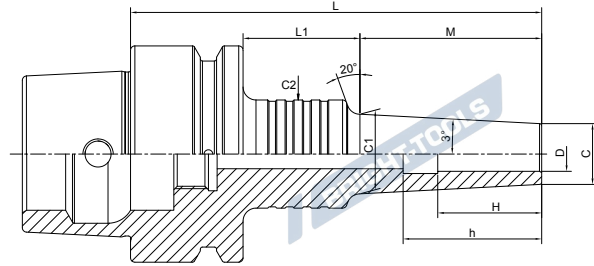

Size	D	C	L	M	L1	C1	C2	H	h
HSK50E-SFSA03-60-M22	03	6	60	22	12	8.3	20	9	50
HSK50E-SFSA03-75-M22	03	6	75	22	27	8.3	25	9	61
HSK50E-SFSA03-80-M42	03	6	80	42	12	10.4	20	9	70
HSK50E-SFSA03-95-M42	03	6	95	42	27	10.4	25	9	81
HSK50E-SFSA04-75-M22	04	7	75	22	27	9.3	25	12	61
HSK50E-SFSA04-95-M42	04	7	95	42	27	11.4	25	12	81
HSK50E-SFSA06-75-M22	06	9.000	75	22	27	11.3	25	18	61
HSK50E-SFSA06-95-M42	06	9	95	42	27	13.4	25	18	81
HSK50E-SFSA06-120-M67	06	9	120	67	27	16	25	18	106
HSK50E-SFSA06-150-M97	06	9	150	97	27	19.2	32	18	135
HSK50E-SFSA08-65-M22	08	11	65	22	17	13.3	26	24	49
HSK50E-SFSA08-75-M22	08	11	75	22	27	15.4	25	24	61
HSK50E-SFSA08-85-M42	08	11	85	42	17	15.4	26	24	67
HSK50E-SFSA08-95-M42	08	11	95	42	27	15.4	25	24	81
HSK50E-SFSA08-120-M67	08	11	120	67	27	18	32	24	105
HSK50E-SFSA08-150-M97	08	11	150	97	27	21.2	32	24	132
HSK50E-SFSA10-65-M22	10	13	65	22	17	15.3	26	30	49
HSK50E-SFSA10-75-M22	10	13	75	22	27	15.3	25	30	61
HSK50E-SFSA10-85-M42	10	13	85	42	17	17.4	26	30	64
HSK50E-SFSA10-95-M42	10	13	95	42	27	17.4	25	30	81
HSK50E-SFSA10-120-M67	10	13	120	67	27	20	32	30	105
HSK50E-SFSA10-150-M97	10	13	150	97	27	23.2	32	30	64
HSK50E-SFSA12-65-M22	12	15	65	22	17	17.3	26	25	49
HSK50E-SFSA12-75-M22	12	15	75	22	27	17.3	25	30	60
HSK50E-SFSA12-95-M42	12	15	95	42	27	19.4	32	30	80
HSK50E-SFSA12-120-M67	12	15	120	67	27	22	32	30	105

Shrink Chuck, 3°, Slim, Form A
热缩刀柄 3 度, 薄壁 A 型

A ↗ ≤0.003	RPM G2.5/25000	AD
----------------------	--------------------------	-----------

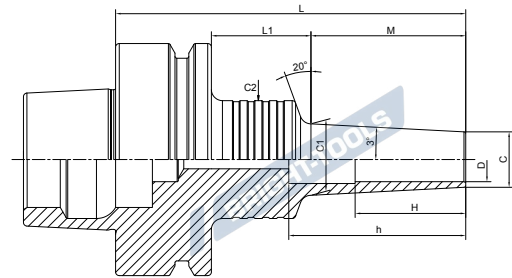

Size	D	C	L	M	L1	C1	C2	H	h
HSK63F-SFSA03-75-M37	03	6	75	37	12	9.9	26	9	58
HSK63F-SFSA03-95-M42	03	6	95	42	27	10.4	25	9	78
HSK63F-SFSA04-95-M42	04	7	95	42	27	11.4	25	12	78
HSK63F-SFSA06-75-M37	06	9	75	37	12	12.9	26	18	58
HSK63F-SFSA06-95-M42	06	9	95	42	27	13.4	25	18	78
HSK63F-SFSA08-95-M42	08	11	95	42	27	15.4	25	24	78
HSK63F-SFSA10-95-M42	10	13	95	42	27	17.4	25	30	74
HSK63F-SFSA12-95-M42	12	15	95	42	27	19.4	32	30	74



Shrink Chuck, 3°, Slim, Form B

热缩刀柄 3 度, 薄壁 B 型

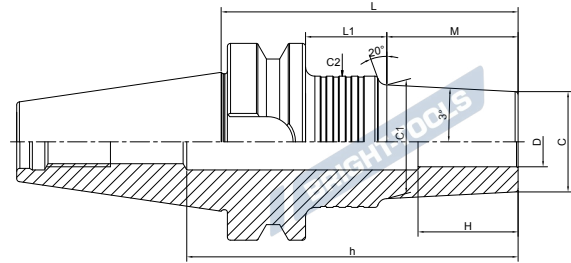
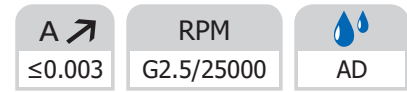

Size	D	C	L	M	L1	C1	C2	H	h
BT40-SFSB06-95-M42	06	10	95	42	26	14.4	25	18	130
BT40-SFSB06-120-M67	06	10	120	67	26	17	25	18	155
BT40-SFSB06-125-M42	06	10	125	42	56	14.4	25	18	160
BT40-SFSB06-150-M67	06	10	150	67	56	17	25	18	185
BT40-SFSB06-150-M97	06	10	150	97	26	20.2	32	18	185
BT40-SFSB06-180-M97	06	10	180	97	56	20.2	32	18	215
BT40-SFSB06-180-M127	06	10	180	127	26	23.3	32	18	215
BT40-SFSB06-210-M127	06	10	210	127	56	23.3	32	18	245
BT40-SFSB06-210-M157	06	10	210	157	26	26.5	32	18	245
BT40-SFSB06-240-M157	06	10	240	157	56	26.5	36	18	275
BT40-SFSB08-95-M42	08	13	95	42	26	17.4	32	24	130
BT40-SFSB08-120-M67	08	13	120	67	26	20	32	24	155
BT40-SFSB08-125-M42	08	13	125	42	56	17.4	36	24	160
BT40-SFSB08-150-M67	08	13	150	67	56	20	32	24	185
BT40-SFSB08-150-M97	08	13	150	97	26	23.2	32	24	185
BT40-SFSB08-180-M97	08	13	180	97	56	23.2	32	24	215
BT40-SFSB08-180-M127	08	13	180	127	26	26.3	32	24	215
BT40-SFSB08-210-M127	08	13	210	127	56	26.3	36	24	245
BT40-SFSB08-210-M157	08	13	210	157	26	29.5	36	24	245
BT40-SFSB08-240-M157	08	13	240	157	56	29.5	42	24	275
BT40-SFSB10-95-M42	10	16	95	42	26	20.4	32	30	130
BT40-SFSB10-120-M67	10	16	120	67	26	23	32	30	155
BT40-SFSB10-125-M42	10	16	125	42	56	20.4	32	30	160
BT40-SFSB10-150-M67	10	16	150	67	56	23	32	30	185
BT40-SFSB10-150-M97	10	16	150	97	26	26.2	32	30	185
BT40-SFSB10-180-M97	10	16	180	97	56	26.2	32	30	215
BT40-SFSB10-180-M127	10	16	180	127	26	29.3	42	30	215
BT40-SFSB10-210-M127	10	16	210	127	56	29.3	50	30	245
BT40-SFSB10-210-M157	10	16	210	157	26	32.5	42	30	245
BT40-SFSB10-240-M127	10	16	240	127	86	29.3	50	30	275
BT40-SFSB10-240-M157	10	16	240	157	56	32.5	50	30	275

Shrink Chuck, 3°, Slim, Form B
热缩刀柄 3 度, 薄壁 B 型



A ↗ ≤0.003	RPM G2.5/25000	AD
---------------	-------------------	----

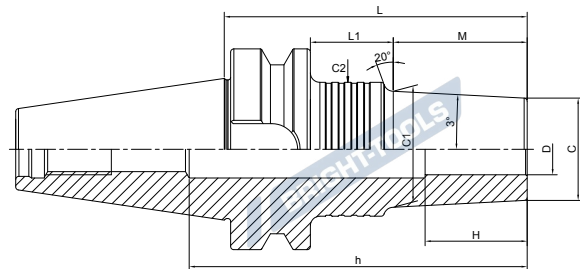

Size	D	C	L	M	L1	C1	C2	H	h
BT40-SFSB12-95-M42	12	19	95	42	26	23.4	32	30	130
BT40-SFSB12-120-M67	12	19	120	67	26	26	32	30	155
BT40-SFSB12-125-M42	12	19	125	42	56	23.4	32	30	160
BT40-SFSB12-150-M67	12	19	150	67	56	26	32	30	185
BT40-SFSB12-150-M97	12	19	150	97	26	29.2	42	30	185
BT40-SFSB12-180-M97	12	19	180	97	56	29.2	50	30	215
BT40-SFSB12-180-M127	12	19	180	127	26	32.3	42	30	215
BT40-SFSB12-210-M97	12	19	210	97	86	29.2	50	30	245
BT40-SFSB12-210-M127	12	19	210	127	56	32.3	50	30	245
BT40-SFSB12-210-M157	12	19	210	157	26	35.5	42	30	245
BT40-SFSB12-240-M127	12	19	240	127	86	32.3	50	30	275
BT40-SFSB12-240-M157	12	19	240	157	56	35.5	50	30	275
BT40-SFSB12-270-M157	12	19	270	157	86	35.5	50	30	305
BT40-SFSB16-95-M42	16	24	95	42	26	28.4	42	32	105
BT40-SFSB16-120-M67	16	24	120	67	26	31	42	32	130
BT40-SFSB16-125-M42	16	24	125	42	56	28.4	42	32	135
BT40-SFSB16-150-M67	16	24	150	67	56	31	42	32	160
BT40-SFSB16-150-M97	16	24	150	97	26	34.2	42	32	160
BT40-SFSB16-180-M97	16	24	180	97	56	34.2	50	32	190
BT40-SFSB16-180-M127	16	24	180	127	26	37.3	53	32	190
BT40-SFSB16-210-M97	16	24	210	97	86	34.2	50	32	220
BT40-SFSB16-210-M127	16	24	210	127	56	37.3	50	32	220
BT40-SFSB16-210-M157	16	24	210	157	26	40.5	53	32	220
BT40-SFSB16-240-M127	16	24	240	127	86	37.3	53	32	250
BT40-SFSB16-240-M157	16	24	240	157	56	40.5	50	32	250
BT40-SFSB16-270-M157	16	24	270	157	86	40.5	50	32	280



Shrink Chuck, 3°, Slim, Form B

热缩刀柄 3 度, 薄壁 B 型

A ↗	RPM	
≤0.003	G2.5/25000	AD

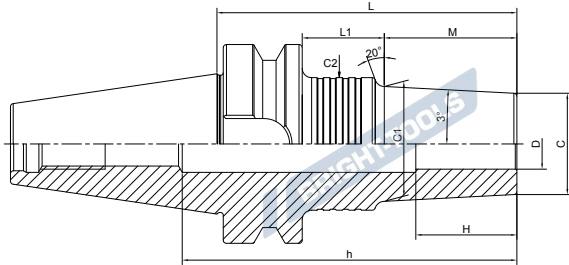

Size	D	C	L	M	L1	C1	C2	H	h
BT40-SFSB20-95-M42	20	29	95	42	26	33.4	42	40	105
BT40-SFSB20-120-M67	20	29	120	67	26	36	42	40	130
BT40-SFSB20-125-M42	20	29	125	42	56	33.4	42	40	135
BT40-SFSB20-150-M67	20	29	150	67	56	36	42	40	160
BT40-SFSB20-150-M97	20	29	150	97	26	39.2	53	40	160
BT40-SFSB20-180-M67	20	29	180	67	86	36	50	40	190
BT40-SFSB20-180-M97	20	29	180	97	56	39.2	50	40	190
BT40-SFSB20-180-M127	20	29	180	127	26	42.3	53	40	190
BT40-SFSB20-210-M97	20	29	210	97	86	39.2	50	40	220
BT40-SFSB20-210-M127	20	29	210	127	56	42.3	50	40	220
BT40-SFSB20-210-M157	20	29	210	157	26	45.5	50	40	220
BT40-SFSB20-240-M127	20	29	240	127	86	42.3	50	40	250
BT40-SFSB20-240-M157	20	29	240	157	56	45.5	50	40	250
BT40-SFSB20-270-M157	20	29	270	157	86	45.5	50	40	280

BRIGHT-TOOLS

BRIGHT-TOOLS

BRIGHT-TOOLS

BRIGHT-TOOLS

Shrink Chuck, 3°, Slim, Form B
热缩刀柄 3 度, 薄壁 B 型

A ↗ ≤0.003	RPM G2.5/25000	AD
---------------	-------------------	----

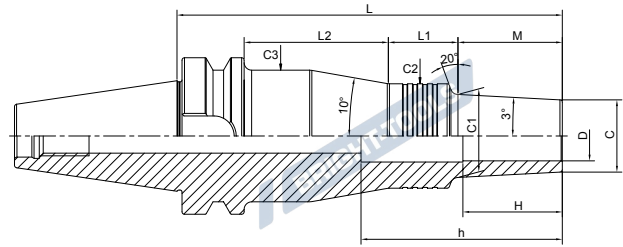

Size	D	C	L	M	L1	L2	C1	C2	C3	H	h
BT40-SFSB06-155-M42	06	10	155	42	33	53	14.4	25	39	18	190
BT40-SFSB06-180-M67	06	10	180	67	33	53	17	25	39	18	215
BT40-SFSB06-210-M97	06	10	210	97	30	56	20.2	32	46	18	245
BT40-SFSB06-240-M127	06	10	240	127	30	56	23.3	32	46	18	275
BT40-SFSB06-270-M157	06	10	270	157	30	56	26.5	32	46	18	305
BT40-SFSB08-155-M42	08	13	155	42	30	56	17.4	32	46	24	190
BT40-SFSB08-180-M67	08	13	180	67	30	56	20	32	46	24	215
BT40-SFSB08-210-M97	08	13	210	97	30	56	23.2	32	46	24	245
BT40-SFSB08-240-M127	08	13	240	127	30	56	26.3	32	46	24	275
BT40-SFSB08-270-M157	08	13	270	157	28	58	29.5	42	53	24	305
BT40-SFSB10-155-M42	10	16	155	42	30	56	20.4	32	46	30	190
BT40-SFSB10-180-M67	10	16	180	67	30	56	23	32	46	30	215
BT40-SFSB10-210-M97	10	16	210	97	30	56	26.2	32	46	30	245
BT40-SFSB10-270-M157	10	16	270	157	28	58	32.5	42	53	30	305
BT40-SFSB12-155-M42	12	19	155	42	30	56	23.4	32	46	30	190
BT40-SFSB12-180-M67	12	19	180	67	28	58	26	36	50	30	215
BT40-SFSB16-155-M42	16	24	155	42	28	58	28.4	42	53	32	165
BT40-SFSB16-180-M67	16	24	180	67	28	58	31	42	53	32	190
BT40-SFSB20-155-M42	20	29	155	42	28	58	33.4	42	53	40	165



Shrink Chuck, 3°, Slim, Form B

热缩刀柄 3 度, 薄壁 B 型

A ↗ ≤0.003	RPM G2.5/25000	 AD
---------------	-------------------	---

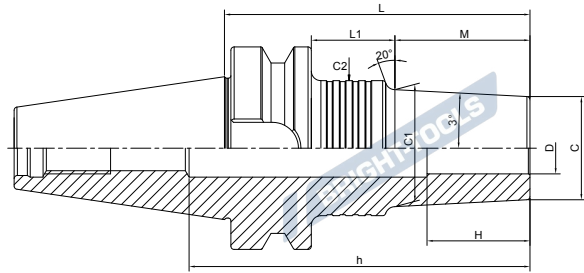

Size	D	C	L	M	L1	C1	C2	H	h
BT50-SFSB06-110-M42	06	10	110	42	30	14.4	25	18	165
BT50-SFSB06-135-M67	06	10	135	67	30	17	25	18	190
BT50-SFSB06-140-M42	06	10	140	42	60	14.4	25	18	195
BT50-SFSB06-165-M67	06	10	165	67	60	17	25	18	220
BT50-SFSB06-165-M97	06	10	165	97	30	20.2	32	18	220
BT50-SFSB06-195-M97	06	10	195	97	60	20.2	32	18	250
BT50-SFSB06-195-MI 27	06	10	195	127	30	23.3	32	18	250
BT50-SFSB06-225-M127	06	10	225	127	60	23.3	32	18	280
BT50-SFSB06-225-M157	06	10	225	157	30	26.5	32	18	280
BT50-SFSB06-255-M157	06	10	255	157	60	26.5	32	18	310
BT50-SFSB08-110-M42	08	13	110	42	30	17.4	32	24	165
BT50-SFSB08-135-M67	08	13	135	67	30	20	32	24	190
BT50-SFSB08-140-M42	08	13	140	42	60	17.4	32	24	195
BT50-SFSB08-165-M67	08	13	165	67	60	20	32	24	220
BT50-SFSB08-165-M97	08	13	165	97	30	23.2	32	24	220
BT50-SFSB08-195-M97	08	13	195	97	60	23.2	32	24	250
BT50-SFSB08-195-M127	08	13	195	127	30	26.3	32	24	250
BT50-SFSB08-225-M127	08	13	225	127	60	26.3	32	24	280
BT50-SFSB08-225-M157	08	13	225	157	30	29.5	42	24	280
BT50-SFSB08-255-M157	08	13	255	157	60	29.5	42	24	310

Shrink Chuck, 3°, Slim, Form B
热缩刀柄 3 度, 薄壁 B 型

A ↗ ≤0.003	RPM G2.5/25000	AD
---------------	-------------------	----

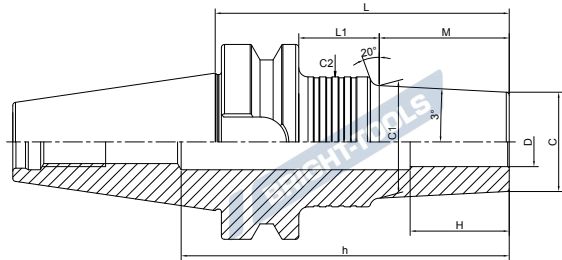

Size	D	C	L	M	L1	C1	C2	H	h
BT50-SFSB10-110-M42	10	16	110	42	30	20.4	32	30	165
BT50-SFSB10-135-M67	10	16	135	67	30	23	32	30	190
BT50-SFSB10-140-M42	10	16	140	42	60	20.4	32	30	195
BT50-SFSB10-165-M67	10	16	165	67	60	23	32	30	220
BT50-SFSB10-165-M97	10	16	165	97	30	26.2	32	30	220
BT50-SFSB10-195-M97	10	16	195	97	60	26.2	32	30	250
BT50-SFSB10-195-M127	10	16	195	127	30	29.3	42	30	250
BT50-SFSB10-225-M127	10	16	225	127	60	29.3	42	30	280
BT50-SFSB10-225-M157	10	16	225	157	30	32.5	42	30	280
BT50-SFSB10-255-M157	10	16	255	157	60	32.5	42	30	310
BT50-SFSB12-110-M42	12	19	110	42	30	23.4	32	30	165
BT50-SFSB12-135-M67	12	19	135	67	30	26	32	30	190
BT50-SFSB12-140-M42	12	19	140	42	60	23.4	32	30	195
BT50-SFSB12-165-M67	12	19	165	67	60	26	32	30	220
BT50-SFSB12-165-M97	12	19	165	97	30	29.2	42	30	220
BT50-SFSB12-195-M97	12	19	195	97	60	29.2	42	30	250
BT50-SFSB12-195-M127	12	19	195	127	30	32.3	42	30	250
BT50-SFSB12-225-M127	12	19	225	127	60	32.3	42	30	280
BT50-SFSB12-225-M157	12	19	225	157	30	35.5	42	30	280
BT50-SFSB12-255-M157	12	19	255	157	60	35.5	42	30	310



Shrink Chuck, 3°, Slim, Form B
热缩刀柄 3 度, 薄壁 B 型

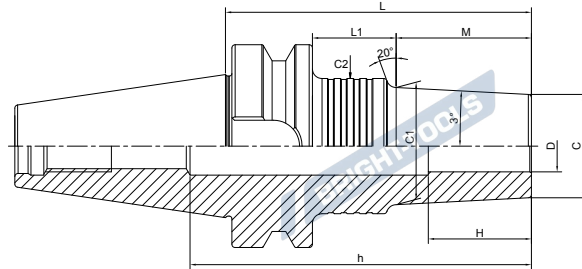

A ↗ ≤0.003	RPM G2.5/25000	AD
---------------	-------------------	----



Size	D	C	L	M	L1	C1	C2	H	h
BT50-SFSB16-110-M42	16	24	110	42	30	28.4	42	32	165
BT50-SFSB16-135-M67	16	24	135	67	30	31	42	32	190
BT50-SFSB16-140-M42	16	24	140	42	60	28.4	42	32	195
BT50-SFSB16-165-M67	16	24	165	67	60	31	42	32	220
BT50-SFSB16-165-M97	16	24	165	97	30	34.2	42	32	220
BT50-SFSB16-195-M97	16	24	195	97	60	34.2	42	32	250
BT50-SFSB16-195-M127	16	24	195	127	30	37.3	53	32	250
BT50-SFSB16-225-M127	16	24	225	127	60	37.3	53	32	280
BT50-SFSB16-225-M157	16	24	225	157	30	40.5	53	32	280
BT50-SFSB16-255-M157	16	24	255	157	60	40.5	53	32	310
BT50-SFSB20-110-M42	20	29	110	42	30	33.4	42	40	165
BT50-SFSB20-135-M67	20	29	135	67	30	36	42	40	190
BT50-SFSB20-140-M42	20	29	140	42	60	33.4	42	40	195
BT50-SFSB20-165-M67	20	29	165	67	60	36	42	40	220
BT50-SFSB20-165-M97	20	29	165	97	30	39.2	53	40	220
BT50-SFSB20-195-M97	20	29	195	97	60	39.2	53	40	250
BT50-SFSB20-195-M127	20	29	195	127	30	42.3	53	40	250
BT50-SFSB20-225-M127	20	29	225	127	60	42.3	53	40	280
BT50-SFSB20-225-M157	20	29	225	157	30	45.5	53	40	280
BT50-SFSB20-255-M157	20	29	255	157	60	45.5	53	40	310

Shrink Chuck, 3°, Slim, Form B

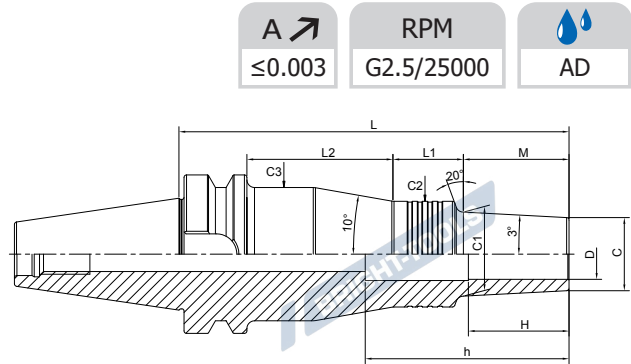
热缩刀柄 3 度, 薄壁 B 型



A ↗ ≤0.003	RPM G2.5/25000	AD
---------------	-------------------	----

Size	D	C	L	M	L1	L2	C1	C2	C3	H	h
BT50-SFSB06-170-M42	06	10	170	42	33	57	14.4	25	39	18	225
BT50-SFSB06-195-M67	06	10	195	67	33	57	17	25	39	18	250
BT50-SFSB06-225-M97	06	10	225	97	30	60	20.2	32	46	18	280
BT50-SFSB06-255-M127	06	10	255	127	30	60	23.3	32	46	18	310
BT50-SFSB06-285-M157	06	10	285	157	30	60	26.5	32	46	18	340
BT50-SFSB08-170-M42	08	13	170	42	30	60	17.4	32	46	24	225
BT50-SFSB08-195-M67	08	13	195	67	30	60	20	32	46	24	250
BT50-SFSB08-225-M97	08	13	225	97	30	60	23.2	32	46	24	280
BT50-SFSB08-255-M127	08	13	255	127	30	60	26.3	32	46	24	310
BT50-SFSB08-285-M157	08	13	285	157	28	62	29.5	42	56	24	340
BT50-SFSB10-170-M42	10	16	170	42	28	62	20.4	36	50	30	225
BT50-SFSB10-195-M67	10	16	195	67	30	60	23	32	46	30	250
BT50-SFSB10-225-M97	10	16	225	97	30	60	26.2	32	46	30	280
BT50-SFSB10-255-M127	10	16	255	127	28	62	29.3	42	56	30	310
BT50-SFSB10-285-M157	10	16	285	157	28	62	32.5	42	56	30	340
BT50-SFSB12-170-M42	12	19	170	42	28	62	23.4	36	50	30	225
BT50-SFSB12-195-M67	12	19	195	67	30	60	26	32	46	30	250
BT50-SFSB12-225-M97	12	19	225	97	28	62	29.2	42	56	30	280
BT50-SFSB12-225-M127	12	19	255	127	28	62	32.3	42	56	30	310
BT50-SFSB12-285-M157	12	19	285	157	28	62	35.5	42	56	30	340
BT50-SFSB16-170-M42	16	24	170	42	28	62	28.4	42	56	32	225
BT50-SFSB16-195-M67	16	24	195	67	28	62	31.0	42	56	32	250
BT50-SFSB16-225-M97	16	24	225	97	28	62	34.2	42	56	32	280
BT50-SFSB16-255-M127	16	24	255	127	28	62	37.3	53	67	32	310
BT50-SFSB16-285-M157	16	24	285	157	28	62	40.5	53	67	32	340
BT50-SFSB20-170-M42	20	29	170	42	28	62	33.4	42	58	40	225
BT50-SFSB20-195-M67	20	29	195	67	28	62	36.0	42	58	40	250
BT50-SFSB20-225-M97	20	29	225	97	28	62	39.2	53	67	40	280
BT50-SFSB20-255-M127	20	29	255	127	28	62	42.3	53	67	40	310
BT50-SFSB20-285-M157	20	29	285	157	28	62	45.5	53	67	40	340

Shrink Chuck, 3°, Slim, Form B
 热缩刀柄 3 度, 薄壁 B 型

A ↗ ≤0.003	RPM G2.5/25000	 AD
---------------	-------------------	--------

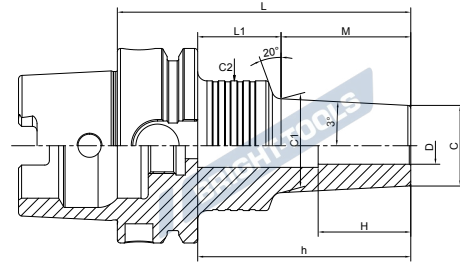

Size	D	C	L	M	L1	C1	C2	H	h
HSK63A-SFSB06-95-M42	06	10	95	42	27	14.4	25	18	70
HSK63A-SFSB06-120-M67	06	10	120	67	27	17	25	18	95
HSK63A-SFSB06-125-M42	06	10	125	42	57	14.4	25	18	100
HSK63A-SFSB06-150-M67	06	10	150	67	57	17	25	18	125
HSK63A-SFSB06-150-M97	06	10	150	97	27	20.2	32	18	124
HSK63A-SFSB06-180-M97	06	10	180	97	57	20.2	32	18	154
HSK63A-SFSB06-180-M127	06	10	180	127	27	23.3	32	18	154
HSK63A-SFSB06-210-M127	06	10	210	127	57	23.3	32	18	184
HSK63A-SFSB06-210-M157	06	10	210	157	27	26.5	32	18	184
HSK63A-SFSB06-240-M157	06	10	240	157	57	26.5	32	18	214
HSK63A-SFSB08-95-M42	08	13	95	42	27	17.4	32	24	69
HSK63A-SFSB08-120-M67	08	13	120	67	27	20	32	24	94
HSK63A-SFSB08-125-M42	08	13	125	42	57	17.4	32	24	99
HSK63A-SFSB08-150-M67	08	13	150	67	57	20	32	24	124
HSK63A-SFSB08-150-M97	08	13	150	97	27	23.2	32	24	124
HSK63A-SFSB08-180-M97	08	13	180	97	57	23.2	32	24	154
HSK63A-SFSB08-180-M127	08	13	180	127	27	26.3	32	24	154
HSK63A-SFSB08-210-M127	08	13	210	127	57	26.3	32	24	184
HSK63A-SFSB08-210-M157	08	13	210	157	27	29.5	42	24	185
HSK63A-SFSB08-240-M157	08	13	240	157	57	29.5	42	24	214
HSK63A-SFSB10-95-M42	10	16	95	42	27	20.4	32	30	69
HSK63A-SFSB10-120-M67	10	16	120	67	27	23	32	30	94
HSK63A-SFSB10-125-M42	10	16	125	42	57	20.4	32	30	99
HSK63A-SFSB10-150-M67	10	16	150	67	57	23	32	30	124
HSK63A-SFSB10-150-M97	10	16	150	97	27	26.2	32	30	124
HSK63A-SFSB10-180-M97	10	16	180	97	57	26.2	32	30	154
HSK63A-SFSB10-180-M127	10	16	180	127	27	29.3	42	30	155
HSK63A-SFSB10-210-M127	10	16	210	127	57	29.3	42	30	182
HSK63A-SFSB10-210-M157	10	16	210	157	27	32.5	42	30	185
HSK63A-SFSB10-240-M127	10	16	240	127	87	29.3	42	30	215
HSK63A-SFSB10-240-M157	10	16	240	157	57	32.5	42	30	215

Shrink Chuck, 3°, Slim, Form B

热缩刀柄 3 度, 薄壁 B 型

A ↗ ≤0.003	RPM G2.5/25000	AD
---------------	-------------------	----

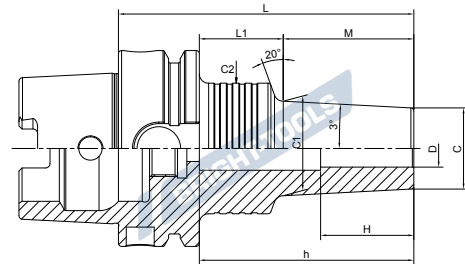

Size	D	C	L	M	L1	C1	C2	H	h
HSK63A-SFSB12-95-M42	12	19	95	42	27	23.4	32	30	69
HSK63A-SFSB12-120-M67	12	19	120	67	27	26	32	30	94
HSK63A-SFSB12-125-M42	12	19	125	42	57	23.4	32	30	99
HSK63A-SFSB12-150-M67	12	19	150	67	57	26	32	30	124
HSK63A-SFSB12-150-M97	12	19	150	97	27	29.2	42	30	125
HSK63A-SFSB12-180-M97	12	19	180	97	57	29.2	42	30	152
HSK63A-SFSB12-180-M127	12	19	180	127	27	32.3	42	30	155
HSK63A-SFSB12-210-M97	12	19	210	97	87	29.2	50	30	180
HSK63A-SFSB12-210-M127	12	19	210	127	57	32.3	50	30	180
HSK63A-SFSB12-210-M157	12	19	210	157	27	35.5	42	30	185
HSK63A-SFSB12-240-M127	12	19	240	127	87	32.3	50	30	215
HSK63A-SFSB12-240-M157	12	19	240	157	57	35.5	50	30	215
HSK63A-SFSB16-95-M42	16	24	95	42	27	28.4	42	32	70
HSK63A-SFSB16-120-M67	16	24	120	67	27	31	42	32	95
HSK63A-SFSB16-125-M42	16	24	125	42	57	28.4	42	32	97
HSK63A-SFSB16-150-M67	16	24	150	67	57	31	42	32	122
HSK63A-SFSB16-150-M97	16	24	150	97	27	34.2	42	32	125
HSK63A-SFSB16-155-M42	16	24	155	42	87	28.4	50	32	130
HSK63A-SFSB16-180-M97	16	24	180	97	57	34.2	42	32	152
HSK63A-SFSB16-180-M127	16	24	180	127	27	37.3	53	32	155
HSK63A-SFSB16-210-M97	16	24	210	97	87	34.2	50	32	185
HSK63A-SFSB16-210-M127	16	24	210	127	57	37.3	53	32	181
HSK63A-SFSB16-210-M157	16	24	210	157	27	40.5	53	32	185
HSK63A-SFSB16-240-M127	16	24	240	127	87	37.3	53	32	211
HSK63A-SFSB16-240-M157	16	24	240	157	57	40.5	50	32	215
HSK63A-SFSB16-270-M157	16	24	270	157	87	40.5	53	32	241



Shrink Chuck, 3°, Slim, Form B
热缩刀柄 3 度, 薄壁 B 型

A ↗ ≤0.003	RPM G2.5/25000	AD
---------------	-------------------	----

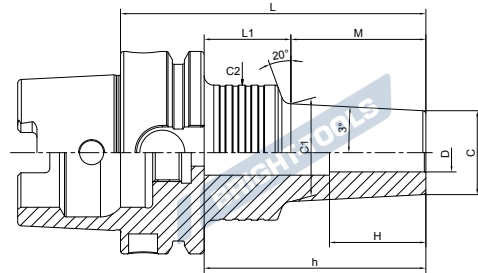

Size	D	C	L	M	L1	C1	C2	H	h
HSK63A-SFSB20-95-M42	20	29	95	42	27	33.4	42	40	70
HSK63A-SFSB20-120-M67	20	29	120	67	27	36	42	40	95
HSK63A-SFSB20-125-M42	20	29	125	42	57	33.4	42	40	97
HSK63A-SFSB20-150-M67	20	29	150	67	57	36	42	40	122
HSK63A-SFSB20-150-M97	20	29	150	97	27	39.2	53	40	125
HSK63A-SFSB20-155-M42	20	29	155	42	87	33.4	50	40	130
HSK63A-SFSB20-180-M97	20	29	180	97	57	39.2	53	40	151
HSK63A-SFSB20-180-M127	20	29	180	127	27	42.3	53	40	155
HSK63A-SFSB20-210-M97	20	29	210	97	87	39.2	53	40	181
HSK63A-SFSB20-210-M127	20	29	210	127	57	42.3	53	40	181
HSK63A-SFSB20-210-M157	20	29	210	157	27	45.5	53	40	185
HSK63A-SFSB20-240-M127	20	29	240	127	87	42.3	50	40	215
HSK63A-SFSB20-240-M157	20	29	240	157	57	45.5	53	40	211
HSK63A-SFSB20-270-M157	20	29	270	157	87	45.5	50	40	245

BRIGHT-TOOLS

BRIGHT-TOOLS

BRIGHT-TOOLS

BRIGHT-TOOLS

Shrink Chuck, 3°, Slim, Form B

热缩刀柄 3 度, 薄壁 B 型

A ↗ ≤0.003	RPM G2.5/25000	AD
---------------	-------------------	----

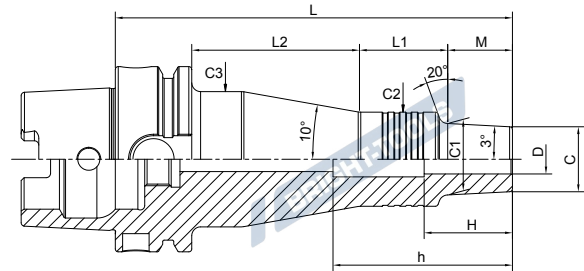

Size	D	C	L	M	L1	C1	C2	C3	H	h
HSK63A-SFSB06-155-M42	06	10	155	42	33	14.4	25	39	18	130
HSK63A-SFSB06-180-M67	06	10	180	67	33	17	25	39	18	155
HSK63A-SFSB06-210-M97	06	10	210	97	30	20.2	32	46	18	184
HSK63A-SFSB06-240-M127	06	10	240	127	30	23.3	32	46	18	214
HSK63A-SFSB06-270-M157	06	10	270	157	30	26.5	32	46	18	244
HSK63A-SFSB08-155-M42	08	13	155	42	30	17.4	32	46	24	129
HSK63A-SFSB08-180-M67	08	13	180	67	30	20	32	46	24	154
HSK63A-SFSB08-210-M97	08	13	210	97	30	23.2	32	46	24	184
HSK63A-SFSB08-240-M127	08	13	240	127	30	26.3	32	46	24	214
HSK63A-SFSB08-270-M157	08	13	270	157	28	29.5	42	53	24	242
HSK63A-SFSB10-155-M42	10	16	155	42	28	20.4	36	50	30	128
HSK63A-SFSB10-180-M67	10	16	180	67	30	23	32	46	30	154
HSK63A-SFSB10-210-M97	10	16	210	97	28	26.2	36	50	30	180
HSK63A-SFSB10-270-M157	10	16	270	157	28	32.5	42	53	30	245
HSK63A-SFSB12-155-M42	12	19	155	42	30	23.4	32	46	30	129
HSK63A-SFSB12-180-M67	12	19	180	67	30	26	32	46	30	154
HSK63A-SFSB12-270-M157	12	19	270	157	28	35.5	42	53	30	242
HSK63A-SFSB16-180-M67	16	24	180	67	28	31	42	53	32	152
HSK63A-SFSB20-180-M67	20	29	180	67	28	36.0	42	53	40	152

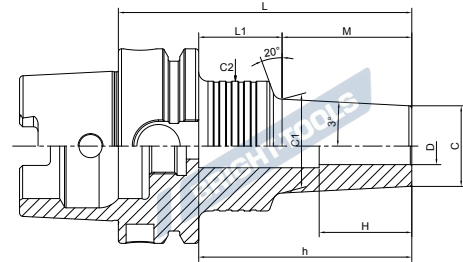
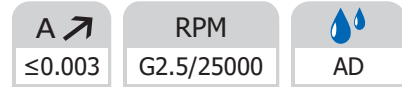

Shrink Chuck, 3°, Slim, Form B
热缩刀柄 3 度, 薄壁 B 型

Size	D	C	L	M	L1	C1	C2	H	h
HSK100A-SFSB06-110-M42	06	10	110	42	39	14.4	25	18	81
HSK100A-SFSB06-135-M67	06	10	135	67	39	17	25	18	106
HSK100A-SFSB06-140-M42	06	10	140	42	69	14.4	25	18	111
HSK100A-SFSB06-165-M67	06	10	165	67	69	17	25	18	136
HSK100A-SFSB06-165-M97	06	10	165	97	39	20.2	32	18	136
HSK100A-SFSB06-195-M97	06	10	195	97	69	20.2	36	18	165
HSK100A-SFSB06-195-M127	06	10	195	127	39	23.3	32	18	166
HSK100A-SFSB06-225-M127	06	10	225	127	69	23.3	32	18	196
HSK100A-SFSB06-225-M157	06	10	225	157	39	26.5	32	18	196
HSK100A-SFSB06-255-M157	06	10	255	157	39	26.5	32	18	226
HSK100A-SFSB08-110-M42	08	13	110	42	39	17.4	32	24	81
HSK100A-SFSB08-135-M67	08	13	135	67	39	20	32	24	106
HSK100A-SFSB08-140-M42	08	13	140	42	69	17.4	32	24	111
HSK100A-SFSB08-165-M67	08	13	165	67	69	20	32	24	136
HSK100A-SFSB08-165-M97	08	13	165	97	39	23.2	32	24	136
HSK100A-SFSB08-195-M97	08	13	195	97	69	23.2	32	24	166
HSK100A-SFSB08-195-M127	08	13	195	127	39	26.3	32	24	166
HSK100A-SFSB08-225-M127	08	13	225	127	69	26.3	32	24	196
HSK100A-SFSB08-225-M157	08	13	225	157	39	29.5	42	24	196
HSK100A-SFSB08-255-M157	08	13	255	157	69	29.5	42	24	226
HSK100A-SFSB10-110-M42	10	16	110	42	39	20.4	32	30	81
HSK100A-SFSB10-135-M67	10	16	135	67	39	23	32	30	106
HSK100A-SFSB10-140-M42	10	16	140	42	69	20.4	32	30	111
HSK100A-SFSB10-165-M67	10	16	165	67	69	23	32	30	136
HSK100A-SFSB10-165-M97	10	16	165	97	39	26.2	32	30	136
HSK100A-SFSB10-195-M97	10	16	195	97	69	26.2	32	30	166
HSK100A-SFSB10-195-M127	10	16	195	127	39	29.3	42	30	166
HSK100A-SFSB10-225-M127	10	16	225	127	69	29.3	42	30	196
HSK100A-SFSB10-225-M157	10	16	225	157	39	32.5	42	30	196
HSK100A-SFSB10-255-M127	10	16	255	127	99	29.3	50	30	225
HSK100A-SFSB10-255-M157	10	16	255	157	69	32.5	42	30	226
HSK100A-SFSB10-285-M157	10	16	285	157	99	32.5	50	30	255

Shrink Chuck, 3°, Slim, Form B
热缩刀柄 3 度, 薄壁 B 型

A ↗ ≤0.003	RPM G2.5/25000	AD
---------------	-------------------	----

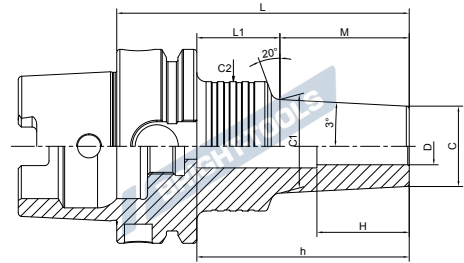

Size	D	C	L	M	L1	C1	C2	H	h
HSK100A-SFSB12-110-M42	12	19	110	42	39	23.4	32	30	79
HSK100A-SFSB12-135-M67	12	19	135	67	39	26	32	30	104
HSK100A-SFSB12-140-M42	12	19	140	42	69	23.4	32	30	109
HSK100A-SFSB12-165-M67	12	19	165	67	69	26	32	30	134
HSK100A-SFSB12-165-M97	12	19	165	97	39	29.2	42	30	133
HSK100A-SFSB12-195-M97	12	19	195	97	69	29.2	50	30	160
HSK100A-SFSB12-195-M127	12	19	195	127	39	32.3	42	30	163
HSK100A-SFSB12-225-M97	12	19	225	97	99	29.2	50	30	190
HSK100A-SFSB12-225-M127	12	19	225	127	69	32.3	42	30	192
HSK100A-SFSB12-225-M157	12	19	225	157	39	35.5	42	30	193
HSK100A-SFSB12-255-M127	12	19	255	127	28	32.3	42	30	222
HSK100A-SFSB12-255-M157	12	19	255	157	69	35.5	42	30	222
HSK100A-SFSB12-285-M157	12	19	285	157	28	35.5	42	30	252
HSK100A-SFSB16-110-M42	16	24	110	42	39	28.4	42	32	78
HSK100A-SFSB16-135-M67	16	24	135	67	39	31	42	32	103
HSK100A-SFSB16-140-M42	16	24	140	42	69	28.4	42	32	107
HSK100A-SFSB16-165-M67	16	24	165	67	69	31	42	32	132
HSK100A-SFSB16-165-M97	16	24	165	97	39	34.2	42	32	133
HSK100A-SFSB16-170-M42	16	24	170	42	99	28.4	50	32	135
HSK100A-SFSB16-195-M67	16	24	195	67	99	31	50	32	160
HSK100A-SFSB16-195-M97	16	24	195	97	69	34.2	42	32	162
HSK100A-SFSB16-195-M127	16	24	195	127	39	37.3	50	32	160
HSK100A-SFSB16-225-M97	16	24	225	97	99	34.2	50	32	190
HSK100A-SFSB16-225-M127	16	24	225	127	69	37.3	53	32	193
HSK100A-SFSB16-225-M157	16	24	225	157	39	40.5	53	32	220
HSK100A-SFSB16-255-M157	16	24	255	157	69	40.5	53	32	220



Shrink Chuck, 3°, Slim, Form B

热缩刀柄 3 度, 薄壁 B 型

A ↗ ≤0.003	RPM G2.5/25000	AD
---------------	-------------------	----

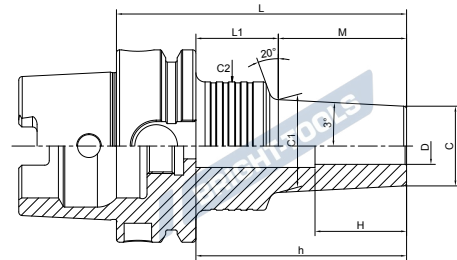

Size	D	C	L	M	L1	C1	C2	H	h
HSK100A-SFSB20-110-M42	20	29	110	42	39	33.4	42	40	78
HSK100A-SFSB20-135-M67	20	29	135	67	39	36	42	40	103
HSK100A-SFSB20-140-M42	20	29	140	42	69	33.4	42	40	107
HSK100A-SFSB20-165-M67	20	29	165	67	69	36	42	40	132
HSK100A-SFSB20-165-M97	20	29	165	97	39	39.2	53	40	133
HSK100A-SFSB20-195-M67	20	29	195	67	28	36	42	40	162
HSK100A-SFSB20-195-M97	20	29	195	97	69	39.2	53	40	162
HSK100A-SFSB20-195-M127	20	29	195	127	39	42.3	53	40	163
HSK100A-SFSB20-225-M97	20	29	225	97	28	39.2	53	40	190
HSK100A-SFSB20-225-M127	20	29	225	127	69	42.3	50	40	190
HSK100A-SFSB20-225-M157	20	29	225	157	39	45.5	53	40	193
HSK100A-SFSB20-255-M127	20	29	255	127	99	42.3	50	40	220
HSK100A-SFSB20-255-M157	20	29	255	157	69	45.5	53	40	220

BRIGHT-TOOLS

BRIGHT-TOOLS

BRIGHT-TOOLS

BRIGHT-TOOLS

Shrink Chuck, 3°, Slim, Form B

热缩刀柄 3 度, 薄壁 B 型



A ↗ ≤0.003	RPM G2.5/25000	AD
---------------	-------------------	----

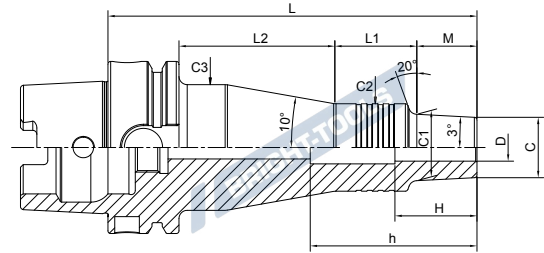

Size	D	C	L	M	L1	L2	C1	C2	C3	H	h
HSK100A-SFSB06-170-M42	06	10	170	42	33	66	14.4	26	40	18	140
HSK100A-SFSB06-195-M67	06	10	195	67	33	66	17	25	39	18	166
HSK100A-SFSB06-225-M97	06	10	225	97	28	71	20.2	36	50	18	195
HSK100A-SFSB06-255-M127	06	10	255	127	30	69	23.3	32	46	18	226
HSK100A-SFSB06-285-M157	06	10	285	157	30	69	26.5	32	46	18	256
HSK100A-SFSB08-170-M42	08	13	170	42	28	71	17.4	36	50	24	140
HSK100A-SFSB08-195-M67	08	13	195	67	30	69	20	32	46	24	166
HSK100A-SFSB08-225-M97	08	13	225	97	30	69	23.2	32	46	24	196
HSK100A-SFSB08-255-M127	08	13	255	127	30	69	26.3	32	46	24	226
HSK100A-SFSB08-285-M157	08	13	285	157	28	71	29.5	42	56	24	256
HSK100A-SFSB10-170-M42	10	16	170	42	30	69	20.4	32	46	30	141
HSK100A-SFSB10-195-M67	10	16	195	67	30	69	23	32	46	30	166
HSK100A-SFSB10-225-M97	10	16	225	97	30	69	26.2	32	46	30	196
HSK100A-SFSB12-170-M42	12	19	170	42	28	71	23.4	36	50	30	135
HSK100A-SFSB12-195-M67	12	19	195	67	30	69	26	32	46	30	164
HSK100A-SFSB12-255-M127	12	19	255	127	28	71	32.3	42	56	30	222
HSK100A-SFSB12-285-M157	12	19	285	157	28	71	35.5	42	56	30	252
HSK100A-SFSB16-255-M127	16	24	255	127	28	71	37.3	53	67	32	220
HSK100A-SFSB16-285-M157	16	24	285	157	28	71	40.5	53	67	32	250
HSK100A-SFSB20-170-M42	20	29	170	42	28	71	33.4	42	56	40	137
HSK100A-SFSB20-195-M67	20	29	195	67	28	71	36	42	56	40	162
HSK100A-SFSB20-225-M97	20	29	225	97	28	71	39	53	67	40	190
HSK100A-SFSB20-285-M157	20	29	285	157	28	71	45.5	53	67	40	250



Shrink Chuck, 3°, Slim, Form B

热缩刀柄 3 度, 薄壁 B 型

A ↗ ≤0.003	RPM G2.5/25000	AD
---------------	-------------------	----

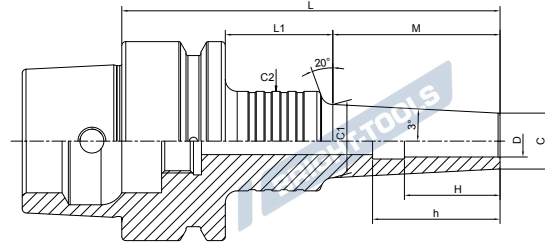

Size	D	C	L	M	L1	C1	C2	H	h
HSK50E-SFSB06-95-M42	06	10	95	42	27	14.4	25	18	81
HSK50E-SFSB06-120-M67	06	10	120	67	27	17	25	18	106
HSK50E-SFSB06-150-M97	06	10	150	97	27	20.2	32	18	135
HSK50E-SFSB08-95-M42	08	13	95	42	27	17.4	32	24	80
HSK50E-SFSB08-120-M67	08	13	120	67	27	20	32	24	105
HSK50E-SFSB08-150-M97	08	13	150	97	27	23.2	32	24	135
HSK50E-SFSB10-95-M42	10	16	95	42	27	20.4	32	30	80
HSK50E-SFSB10-120-M67	10	16	120	67	27	23	32	30	105
HSK50E-SFSB10-150-M97	10	16	150	97	27	26.2	32	30	135
HSK50E-SFSB12-95-M42	12	19	95	42	27	23.4	32	30	80
HSK50E-SFSB12-120-M67	12	19	120	67	27	26	32	30	105
HSK50E-SFSB12-150-M97	12	19	150	97	27	29.2	32	30	135
HSK50E-SFSB16-95-M42	16	24	95	42	27	28.4	42	32	82
HSK50E-SFSB16-120-M67	16	24	120	67	27	31	42	32	107
HSK50E-SFSB20-95-M42	20	29	95	42	27	33.4	42	40	82

Shrink Chuck, 3°, Slim, Form B
热缩刀柄 3 度, 薄壁 B 型

A ↗ ≤0.003	RPM G2.5/25000	AD
---------------	-------------------	----

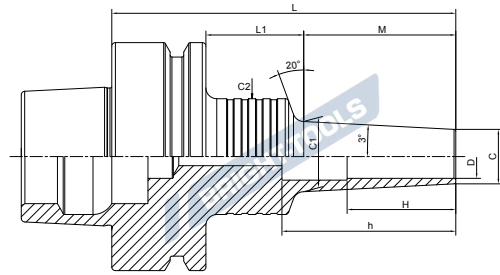

Size	D	C	L	M	L1	C1	C2	H	h
HSK63F-SFSB06-95-M42	06	10	95	42	27	14.4	25	18	78
HSK63F-SFSB08-95-M42	08	13	95	42	27	17.4	32	24	78
HSK63F-SFSB10-95-M42	10	16	95	42	27	20.4	32	30	74
HSK63F-SFSB12-95-M42	12	19	95	42	27	23.4	32	30	74



Shrink Chuck, 3°, Regular, Form A

热缩刀柄 3 度, 标准 A 型



A ↗	RPM	
≤0.003	G2.5/25000	AD

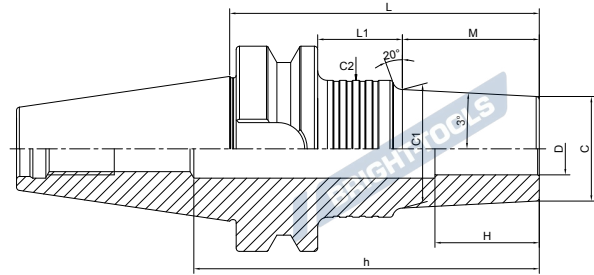

Size	D	C	L	M	L1	C1	C2	H	h
BT30-SFRA03-75-M22	03	7.5	75	22	31	9.8	25	9	99
BT30-SFRA04-75-M22	04	10	75	22	31	12.3	25	12	99
BT30-SFRA06-75-M22	06	12	75	22	31	14.3	25	18	99
BT30-SFRA08-75-M22	08	14	75	22	31	16.3	25	24	99
BT30-SFRA10-75-M22	10	16	75	22	31	18.3	25	30	99
BT30-SFRA12-75-M22	12	20	75	22	31	22.3	25	30	99
BT30-SFRA16-60-M22	16	26	60	22	16	28.3	34	32	60
BT30-SFRA20-65-M22	20	32	65	22	21	34.3	40	38	60
BT40-SFRA03-75-M22	03	7.5	75	22	26	9.8	25	9	110
BT40-SFRA03-95-M42	03	7.5	95	42	26	11.9	25	9	130
BT40-SFRA03-105-M22	03	7.5	105	22	56	9.8	26	9	140
BT40-SFRA03-120-M67	03	7.5	120	67	26	14.5	26	9	155
BT40-SFRA03-125-M42	03	7.5	125	42	56	11.9	26	9	160
BT40-SFRA03-150-M67	03	7.5	150	67	56	14.5	26	9	185
BT40-SFRA03-150-M97	03	7.5	150	97	26	17.7	26	9	185
BT40-SFRA03-180-M97	03	7.5	180	97	56	17.7	26	9	215
BT40-SFRA03-180-M127	03	7.5	180	127	26	20.8	36	9	215
BT40-SFRA03-210-M127	03	7.5	210	127	56	20.8	36	9	245
BT40-SFRA04-75-M22	04	10	75	22	26	12.3	25	12	110
BT40-SFRA04-95-M42	04	10	95	42	26	14.4	26	12	130
BT40-SFRA04-105-M22	04	10	105	22	56	12.3	26	12	140
BT40-SFRA04-120-M67	04	10	120	67	26	17	25	12	155
BT40-SFRA04-125-M42	04	10	125	42	56	14.4	26	12	160
BT40-SFRA04-150-M67	04	10	150	67	56	17	25	12	185
BT40-SFRA04-150-M97	04	10	150	97	26	20.2	25	12	185
BT40-SFRA04-180-M97	04	10	180	97	56	20.2	26	12	215
BT40-SFRA04-180-M127	04	10	180	127	26	23.3	36	12	215
BT40-SFRA04-210-M127	04	10	210	127	56	23.3	36	12	245

Shrink Chuck, 3°, Regular, Form A
热缩刀柄 3 度, 标准 A 型

A ↗ ≤0.003	RPM G2.5/25000	AD
---------------	-------------------	----

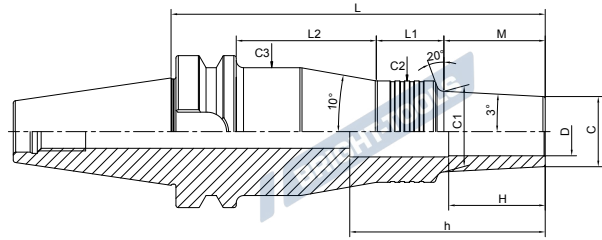

Size	D	C	L	M	L1	L2	C1	C2	C3	H	h
BT40-SFRA03-135-M22	03	7.5	135	22	33	53	9.8	25	39	9	170
BT40-SFRA03-155-M42	03	7.5	155	42	33	53	11.9	26	40	9	190
BT40-SFRA03-180-M67	03	7.5	180	67	33	53	14.5	26	40	9	215
BT40-SFRA03-210-M97	03	7.5	210	97	33	53	17.7	26	40	9	245
BT40-SFRA03-240-M127	03	7.5	240	127	28	58	20.8	36	50	9	275
BT40-SFRA04-135-M22	04	10	135	22	33	53	12.3	26	40	12	170
BT40-SFRA04-155-M42	04	10	155	42	33	53	14.4	26	40	12	190
BT40-SFRA04-180-M67	04	10	180	67	33	53	17	25	39	12	215
BT40-SFRA04-210-M97	04	10	210	97	33	53	20.2	26	40	12	245
BT40-SFRA04-240-M127	04	10	240	127	28	58	23.3	36	50	12	275



Shrink Chuck, 3°, Regular, Form A

热缩刀柄 3 度, 标准 A 型

A ↗	RPM	
≤0.003	G2.5/25000	AD

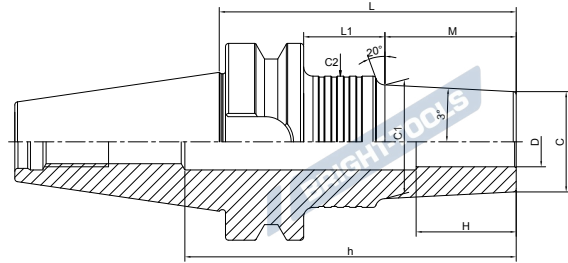

Size	D	C	L	M	L1	C1	C2	H	h
BT50-SFRA03-90-M22	03	7.5	90	22	30	9.8	25	9	145
BT50-SFRA03-110-M42	03	7.5	110	42	30	11.9	26	9	165
BT50-SFRA03-120-M22	03	7.5	120	22	60	9.8	26	9	175
BT50-SFRA03-135-M67	03	7.5	135	67	30	14.5	26	9	190
BT50-SFRA03-140-M42	03	7.5	140	42	60	11.9	26	9	195
BT50-SFRA03-165-M67	03	7.5	165	67	60	14.5	26	9	220
BT50-SFRA03-165-M97	03	7.5	165	97	30	17.7	26	9	220
BT50-SFRA03-195-M97	03	7.5	195	97	60	17.7	26	9	250
BT50-SFRA03-195-M127	03	7.5	195	127	30	20.8	32	9	250
BT50-SFRA03-225-M127	03	7.5	225	127	60	20.8	36	9	280
BT50-SFRA04-90-M22	04	10	90	22	30	12.3	25	12	145
BT50-SFRA04-110-M42	04	10	110	42	30	14.4	26	12	165
BT50-SFRA04-120-M22	04	10	120	22	60	12.3	25	12	175
BT50-SFRA04-135-M67	04	10	135	67	30	17	26	12	190
BT50-SFRA04-140-M42	04	10	140	42	60	14.4	26	12	195
BT50-SFRA04-165-M67	04	10	165	67	60	17	26	12	220
BT50-SFRA04-165-M97	04	10	165	97	30	20.2	26	12	220
BT50-SFRA04-195-M97	04	10	195	97	60	20.2	26	12	250
BT50-SFRA04-195-M127	04	10	195	127	30	23.3	36	12	250
BT50-SFRA04-225-M127	04	10	225	127	60	23.3	36	12	280

Shrink Chuck, 3°, Regular, Form A
热缩刀柄 3 度, 标准 A 型

A ↗ ≤0.003	RPM G2.5/25000	AD
---------------	-------------------	----

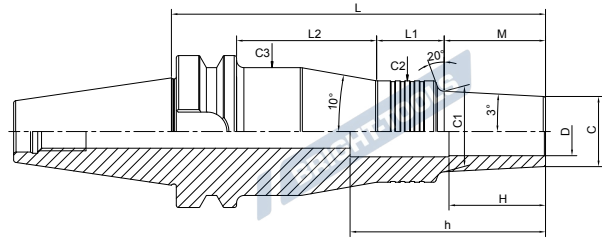

Size	D	C	L	M	L1	L2	C1	C2	C3	H	h
BT50-SFRA03-150-M22	03	7.5	150	22	33	57	9.8	25	39	9	205
BT50-SFRA03-170-M42	03	7.5	170	42	33	57	11.9	25	40	9	225
BT50-SFRA03-195-M67	03	7.5	195	67	33	57	14.5	25	40	9	250
BT50-SFRA03-225-M97	03	7.5	225	97	33	57	17.7	26	40	9	280
BT50-SFRA03-255-M127	03	7.5	255	127	30	60	20.8	32	46	9	310
BT50-SFRA04-150-M22	04	10	150	22	33	57	12.3	25	39	12	205
BT50-SFRA04-170-M42	04	10	170	42	33	57	14.4	26	40	12	225
BT50-SFRA04-195-M67	04	10	195	67	33	57	17	26	40	12	250
BT50-SFRA04-225-M97	04	10	225	97	33	57	20.2	26	40	12	280
BT50-SFRA04-255-M127	04	10	255	127	30	60	23.3	32	46	12	310



Shrink Chuck, 3°, Regular, Form A
热缩刀柄 3 度, 标准 A 型

A ↗ ≤0.003	RPM G2.5/25000	AD
---------------	-------------------	----

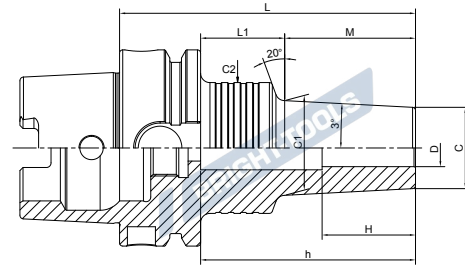

Size	D	C	L	M	L1	C1	C2	H	h
HSK40A-SFRA03-65-M22	03	7.5	65	22	23	9.8	25	9	44
HSK40A-SFRA03-85-M42	03	7.5	85	42	23	11.9	25	9	64
HSK40A-SFRA04-65-M22	04	10	65	22	23	12.3	25	12	44
HSK40A-SFRA04-85-M42	04	10	85	42	23	14.4	25	12	64
HSK40A-SFRA06-65-M22	06	12	65	22	23	14.3	25	18	44
HSK40A-SFRA06-85-M42	06	12	85	42	23	16.4	25	18	64
HSK40A-SFRA08-65-M22	08	14	65	22	23	16.3	25	24	44
HSK40A-SFRA08-85-M42	08	14	85	42	23	18.4	25	24	64
HSK40A-SFRA10-65-M22	10	16	65	22	23	18.3	25	30	44
HSK40A-SFRA10-90-M42	10	16	90	42	28	20.4	32	30	60
HSK40A-SFRA12-65-M22	12	20	65	22	23	22.3	25	30	44
HSK40A-SFRA16-65-M22	16	26	65	22	23	28.3	34	32	43
HSK40A-SFRA20-70-M50	20	32	70	50	-	34	-	38	48
HSK50A-SFRA03-75-M22	03	7.5	75	22	27	9.8	25	9	49
HSK50A-SFRA03-95-M42	03	7.5	95	42	27	11.9	25	9	69
HSK50A-SFRA03-125-M42	03	7.5	125	42	57	11.9	25	9	100
HSK50A-SFRA04-75-M22	04	10	75	22	27	12.3	25	12	49
HSK50A-SFRA04-95-M42	04	10	95	42	27	14.4	25	12	69
HSK50A-SFRA04-125-M42	04	10	125	42	57	14.4	25	12	99

Shrink Chuck, 3°, Regular, Form A
热缩刀柄 3 度, 标准 A 型



A ↗ ≤0.003	RPM G2.5/25000	 AD
----------------------	--------------------------	--------

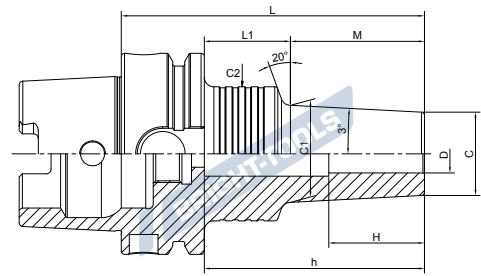

Size	D	C	L	M	L1	C1	C2	H	h
HSK63A-SFRA03-75-M22	03	7.5	75	22	27	9.8	25	9	50
HSK63A-SFRA03-95-M42	03	7.5	95	42	27	11.9	25	9	70
HSK63A-SFRA03-105-M22	03	7.5	105	22	57	9.8	26	9	80
HSK63A-SFRA03-120-M67	03	7.5	120	67	27	14.5	26	9	95
HSK63A-SFRA03-125-M42	03	7.5	125	42	57	11.9	26	9	100
HSK63A-SFRA03-150-M67	03	7.5	150	67	57	14.5	25	9	125
HSK63A-SFRA03-150-M97	03	7.5	150	97	27	17.7	25	9	125
HSK63A-SFRA03-180-M97	03	7.5	180	97	57	17.7	26	9	155
HSK63A-SFRA03-180-M127	03	7.5	180	127	27	20.8	36	9	155
HSK63A-SFRA03-210-M127	03	7.5	210	127	57	20.8	36	9	185
HSK63A-SFRA04-75-M22	04	10	75	22	27	12.3	25	12	50
HSK63A-SFRA04-95-M42	04	10	95	42	27	14.4	25	12	70
HSK63A-SFRA04-105-M22	04	10	105	22	57	12.3	26	12	80
HSK63A-SFRA04-120-M67	04	10	120	67	27	17	25	12	95
HSK63A-SFRA04-125-M42	04	10	125	42	57	14.4	26	12	100
HSK63A-SFRA04-150-M67	04	10	150	67	57	17	26	12	125
HSK63A-SFRA04-150-M97	04	10	150	97	27	20.2	25	12	125
HSK63A-SFRA04-180-M97	04	10	180	97	57	20.2	26	12	155
HSK63A-SFRA04-180-M127	04	10	180	127	27	23.3	36	12	155
HSK63A-SFRA04-210-M127	04	10	210	127	57	23.3	36	12	185



Shrink Chuck, 3°, Regular, Form A
热缩刀柄 3 度, 标准 A 型

A ↗ ≤0.003	RPM G2.5/25000	AD
---------------	-------------------	----

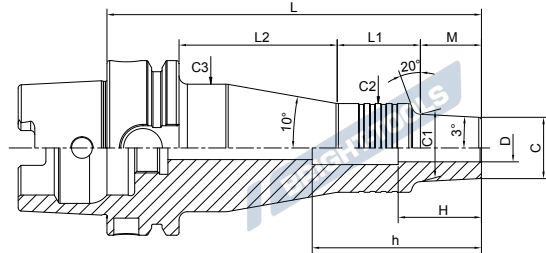

Size	D	C	L	M	L1	C1	C2	H	h
HSK63A-SFRA03-135-M22	03	7.5	135	22	33	9.8	25	9	110
HSK63A-SFRA03-155-M42	03	7.5	155	42	33	11.9	26	9	130
HSK63A-SFRA03-180-M67	03	7.5	180	67	33	14.5	26	9	155
HSK63A-SFRA03-210-M97	03	7.5	210	97	33	17.7	26	9	185
HSK63A-SFRA03-240-M127	03	7.5	240	127	28	20.8	36	9	215
HSK63A-SFRA04-135-M22	04	10	135	22	33	12.3	26	12	110
HSK63A-SFRA04-155-M42	04	10	155	42	33	14.4	25	12	130
HSK63A-SFRA04-180-M67	04	10	180	67	33	17	25	12	155
HSK63A-SFRA04-210-M97	04	10	210	97	33	20.2	26	12	185
HSK63A-SFRA04-240-M127	04	10	240	127	28	23.3	36	12	215

Shrink Chuck, 3°, Regular, Form A
热缩刀柄 3度, 标准 A 型

A ↗ ≤0.003	RPM G2.5/25000	AD
---------------	-------------------	----

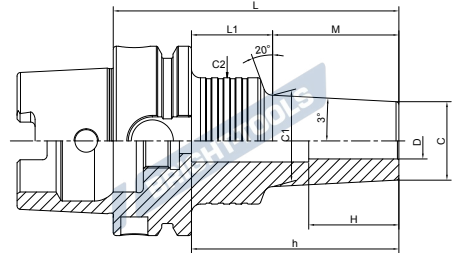

Size	D	C	L	M	L1	C1	C2	H	h
HSK100A-SFRA03-90-M22	03	7.5	90	22	39	9.8	26	9	60
HSK100A-SFRA03-110-M42	03	7.5	110	42	39	11.9	26	9	80
HSK100A-SFRA03-120-M22	03	7.5	120	22	69	9.8	25	9	90
HSK100A-SFRA03-135-M67	03	7.5	135	67	39	14.5	26	9	105
HSK100A-SFRA03-140-M42	03	7.5	140	42	69	11.9	26	9	110
HSK100A-SFRA03-165-M67	03	7.5	165	67	69	14.5	26	9	135
HSK100A-SFRA03-165-M97	03	7.5	165	97	39	17.7	26	9	135
HSK100A-SFRA03-195-M97	03	7.5	195	97	69	17.7	26	9	165
HSK100A-SFRA03-195-M127	03	7.5	195	127	39	20.8	36	9	165
HSK100A-SFRA03-225-M127	03	7.5	225	127	69	20.8	36	9	195
HSK100A-SFRA04-90-M22	04	10	90	22	39	12.3	26	12	60
HSK100A-SFRA04-110-M42	04	10	110	42	39	14.4	26	12	80
HSK100A-SFRA04-120-M22	04	10	120	22	69	12.3	26	12	90
HSK100A-SFRA04-135-M67	04	10	135	67	39	17	26	12	105
HSK100A-SFRA04-140-M42	04	10	140	42	69	14.4	26	12	110
HSK100A-SFRA04-165-M67	04	10	165	67	69	17	26	12	135
HSK100A-SFRA04-165-M97	04	10	165	97	39	20.2	26	12	135
HSK100A-SFRA04-195-M97	04	10	195	97	69	20.2	26	12	165
HSK100A-SFRA04-195-M127	04	10	195	127	39	23.3	32	12	165
HSK100A-SFRA04-225-M127	04	10	225	127	69	23.3	36	12	195



Shrink Chuck, 3°, Regular, Form A
热缩刀柄 3 度, 标准 A 型

A ↗ ≤0.003	RPM G2.5/25000	AD
---------------	-------------------	----

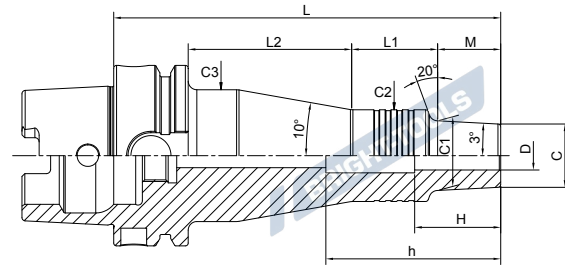

Size	D	C	L	M	L1	L2	C1	C2	C3	H	h
HSK100A-SFRA03-150-M22	03	7.5	150	22	33	66	9.8	26	40	9	120
HSK100A-SFRA03-170-M42	03	7.5	170	42	33	66	11.9	26	40	9	140
HSK100A-SFRA03-195-M67	03	7.5	195	67	33	66	14.5	26	40	9	165
HSK100A-SFRA03-225-M97	03	7.5	225	97	33	66	17.7	26	40	9	195
HSK100A-SFRA03-255-M127	03	7.5	255	127	28	71	20.8	36	50	9	225
HSK100A-SFRA04-150-M22	04	10	150	22	33	66	12.3	26	40	12	120
HSK100A-SFRA04-170-M42	04	10	170	42	33	66	14.4	26	40	12	140
HSK100A-SFRA04-195-M67	04	10	195	67	33	66	17	25	39	12	165
HSK100A-SFRA04-225-M97	04	10	225	97	33	66	20.2	26	40	12	195
HSK100A-SFRA04-255-M127	04	10	255	127	28	71	23.3	36	50	12	225

Shrink Chuck, 3°, Regular, Form A
热缩刀柄 3 度, 标准 A 型

A ↗ ≤0.003	RPM G2.5/25000	AD
----------------------	-------------------	----

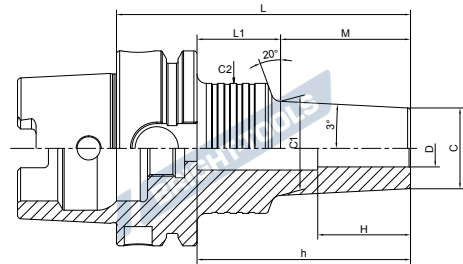

Size	D	C	L	M	L1	C1	C2	H	h
HSK32E-SFRA03-50-M22	03	7.5	50	22	8	9.8	20	9	42
HSK32E-SFRA03-70-M42	03	7.5	70	42	8	11.9	20	9	62
HSK32E-SFRA03-85-M42	03	7.5	85	42	23	11.9	25	9	69
HSK32E-SFRA04-50-M22	04	10	50	22	8	12.3	20	12	35
HSK32E-SFRA04-70-M42	04	10	70	42	8	14.4	20	12	54
HSK32E-SFRA04-85-M42	04	10	85	42	23	14.4	25	12	69
HSK32E-SFRA06-50-M22	06	12	50	22	8	14.3	26	18	39
HSK32E-SFRA06-70-M42	06	12	70	42	8	16.4	26	18	54
HSK32E-SFRA06-85-M42	06	12	85	42	23	16.4	25	18	69
HSK32E-SFRA08-50-M22	08	14	50	22	8	16.3	26	20	39
HSK32E-SFRA08-85-M42	08	14	85	42	23	18.4	25	24	49
HSK32E-SFRA10-55-M22	10	16	55	22	13	18.3	26	25	44
HSK32E-SFRA12-55-M22	12	20	55	22	13	22.3	26	25	44
HSK32E-SFRA16-55-M35	16	26	55	35	-	-	-	32	44



Shrink Chuck, 3°, Regular, Form A

热缩刀柄 3 度, 标准 A 型

A ↗	RPM	
≤0.003	G2.5/25000	AD

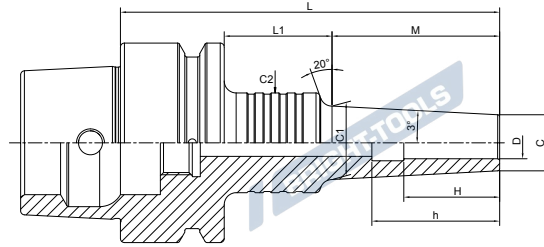

Size	D	C	L	M	L1	C1	C2	H	h
HSK40E-SFRA03-50-M22	03	7.5	50	22	8	9.8	20	9	42
HSK40E-SFRA03-70-M42	03	7.5	70	42	8	11.9	20	9	62
HSK40E-SFRA03-85-M42	03	7.5	85	42	23	11.9	25	9	69
HSK40E-SFRA03-110-M67	03	7.5	110	67	23	14.5	25	9	94
HSK40E-SFRA04-50-M22	04	10	50	22	8	12.3	20	12	42
HSK40E-SFRA04-70-M42	04	10	70	42	8	14.4	20	12	62
HSK40E-SFRA04-85-M42	04	10	85	42	23	14.4	25	12	69
HSK40E-SFRA04-110-M67	04	10	110	67	23	17	25	12	94
HSK40E-SFRA06-50-M22	06	12	50	22	8	14.3	26	18	39
HSK40E-SFRA06-70-M42	06	12	70	42	8	16.4	26	18	54
HSK40E-SFRA06-85-M42	06	12	85	42	23	16.4	25	18	69
HSK40E-SFRA06-110-M67	06	12	110	67	23	19	25	18	94
HSK40E-SFRA08-50-M22	08	14	50	22	8	16.3	26	20	39
HSK40E-SFRA08-85-M42	08	14	85	42	23	18.4	25	24	69
HSK40E-SFRA08-100-M42	08	14	100	42	38	18.4	25	24	84
HSK40E-SFRA10-55-M22	10	16	55	22	13	18.3	26	25	44
HSK40E-SFRA10-85-M42	10	16	85	42	23	20.4	25	30	64
HSK40E-SFRA10-100-M42	10	16	100	42	38	20.4	25	30	64
HSK40E-SFRA12-55-M22	12	20	55	22	13	22.3	30	25	44
HSK40E-SFRA12-85-M42	12	20	85	42	23	24.4	32	30	74
HSK40E-SFRA16-55-M22	16	26	55	22	13	28.3	34	32	44
HSK40E-SFRA20-60-M40	20	32	60	40	-	34	-	38	49

Shrink Chuck, 3°, Regular, Form A
热缩刀柄 3 度, 标准 A 型

A ↗ ≤0.003	RPM G2.5/25000	AD
---------------	-------------------	----

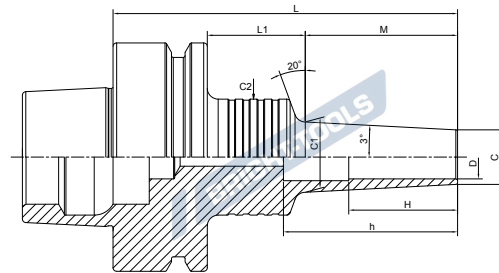

Size	D	C	L	M	L1	C1	C2	H	h
HSK50E-SFRA03-75-M22	03	7.5	75	22	27	9.8	25	9	61
HSK50E-SFRA03-95-M42	03	7.5	95	42	27	11.9	25	9	81
HSK50E-SFRA03-120-M67	03	7.5	120	67	27	14.5	25	9	106
HSK50E-SFRA03-150-M97	03	7.5	150	97	27	17.7	25	9	136
HSK50E-SFRA04-75-M22	04	10	75	22	27	12.3	25	12	61
HSK50E-SFRA04-95-M42	04	10	95	42	27	14.4	25	12	81
HSK50E-SFRA04-120-M67	04	10	120	67	27	17	25	12	106
HSK50E-SFRA04-150-M97	04	10	150	97	27	20.2	25	12	135
HSK50E-SFRA06-60-M22	06	12	60	22	12	14.3	26	18	44
HSK50E-SFRA06-75-M22	06	12	75	22	27	14.3	25	18	61
HSK50E-SFRA06-95-M42	06	12	95	42	27	16.4	25	18	81
HSK50E-SFRA06-120-M67	06	12	120	67	27	19	25	18	106
HSK50E-SFRA08-60-M22	08	14	60	22	12	16.3	26	20	44
HSK50E-SFRA08-75-M22	08	14	75	22	27	16.3	25	24	61
HSK50E-SFRA08-95-M42	08	14	95	42	27	18.4	25	24	81
HSK50E-SFRA10-60-M22	10	16	60	22	12	18.3	26	25	44
HSK50E-SFRA10-75-M22	10	16	75	22	27	18.3	25	30	60
HSK50E-SFRA12-60-M22	12	20	60	22	12	22.3	26	25	44
HSK50E-SFRA12-75-M22	12	20	75	22	27	22.3	25	30	62
HSK50E-SFRA16-60-M22	16	26	60	22	12	28.3	34	32	44
HSK50E-SFRA20-65-M22	20	32	65	22	17	34.3	40	38	49



Shrink Chuck, 3°, Regular, Form A
热缩刀柄 3 度, 标准 A 型

A ↗ ≤0.003	RPM G2.5/25000	AD
---------------	-------------------	----

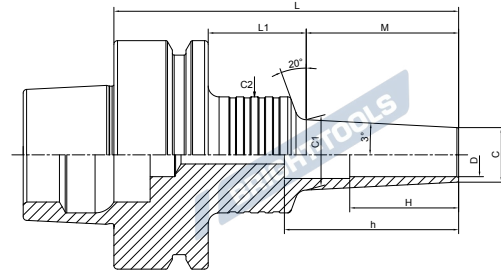

Size	D	C	L	M	L1	C1	C2	H	h
HSK63F-SFRA03-70-M22	03	7.5	70	22	22	9.8	26	9	53
HSK63F-SFRA03-75-M22	03	7.5	75	22	27	9.8	25	9	54
HSK63F-SFRA03-95-M42	03	7.5	95	42	27	11.9	25	9	78
HSK63F-SFRA04-70-M22	04	10	70	22	22	12.3	26	12	53
HSK63F-SFRA04-75-M22	04	10	75	22	27	12.3	25	12	58
HSK63F-SFRA04-95-M42	04	10	95	42	27	14.4	25	12	73
HSK63F-SFRA06-70-M22	06	12	70	22	22	14.3	26	18	53
HSK63F-SFRA06-75-M22	06	12	75	22	27	14.3	25	18	58
HSK63F-SFRA06-95-M42	06	12	95	42	27	16.4	25	18	73
HSK63F-SFRA08-70-M22	08	14	70	22	22	16.3	26	24	53
HSK63F-SFRA08-75-M22	08	14	75	22	27	16.3	25	24	58
HSK63F-SFRA08-95-M42	08	14	95	42	27	18.4	25	24	78
HSK63F-SFRA10-70-M22	10	16	70	22	22	18.3	26	30	53
HSK63F-SFRA10-75-M22	10	16	75	22	27	18.3	25	30	54
HSK63F-SFRA12-70-M22	12	20	70	22	22	22.3	26	30	53
HSK63F-SFRA12-75-M22	12	20	75	22	27	22.3	25	30	54

Shrink Chuck, 3°, Regular, Form B
热缩刀柄 3 度, 标准 B 型

A ↗ ≤0.003	RPM G2.5/25000	AD
----------------------	--------------------------	-----------

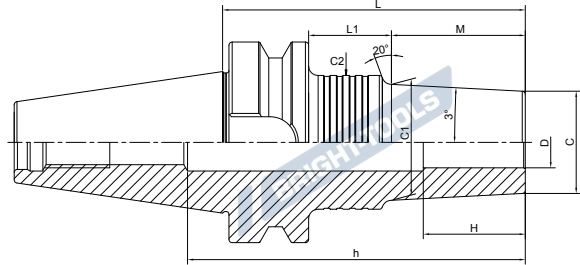

Size	D	C	L	M	L1	C1	C2	H	h
BT40-SFRB06-75-M22	6	14	75	22	26	16.3	32	18	110
BT40-SFRB06-95-M42	6	14	95	42	26	18.4	32	18	130
BT40-SFRB06-105-M22	6	14	105	22	56	16.3	36	18	140
BT40-SFRB06-120-M67	6	14	120	67	26	21	32	18	155
BT40-SFRB06-125-M42	6	14	125	42	56	18.4	32	18	160
BT40-SFRB06-150-M67	6	14	150	67	56	21	32	18	185
BT40-SFRB08-75-M22	8	18	75	22	26	20.3	32	24	110
BT40-SFRB08-95-M42	8	18	95	42	26	22.4	32	24	130
BT40-SFRB08-105-M22	8	18	105	22	56	20.3	32	24	140
BT40-SFRB08-120-M67	8	18	120	67	26	25	36	24	155
BT40-SFRB08-125-M42	8	18	125	42	56	22.4	32	24	160
BT40-SFRB08-150-M67	8	18	150	67	56	25	32	24	185
BT40-SFRB10-75-M22	10	22	75	22	26	24.3	32	30	110
BT40-SFRB10-95-M42	10	22	95	42	26	26.4	32	30	130
BT40-SFRB10-105-M22	10	22	105	22	56	24.3	32	30	140
BT40-SFRB10-120-M67	10	22	120	67	26	29	42	30	155
BT40-SFRB10-125-M42	10	22	125	42	56	26.4	32	30	160
BT40-SFRB10-150-M67	10	22	150	67	56	29	42	30	185
BT40-SFRB12-75-M22	12	26	75	22	26	28.3	42	30	110
BT40-SFRB12-95-M42	12	26	95	42	26	30.4	42	30	130
BT40-SFRB12-105-M22	12	26	105	22	56	28.3	42	30	140
BT40-SFRB12-120-M67	12	26	120	67	26	33	50	30	155
BT40-SFRB12-125-M42	12	26	125	42	56	30.4	50	30	160
BT40-SFRB12-135-M22	12	26	135	22	86	28.3	50	30	170
BT40-SFRB12-150-M67	12	26	150	67	56	33	42	30	185



Shrink Chuck, 3°, Regular, Form B

热缩刀柄 3 度, 标准 B 型

A ↗ ≤0.003	RPM G2.5/25000	AD
---------------	-------------------	----

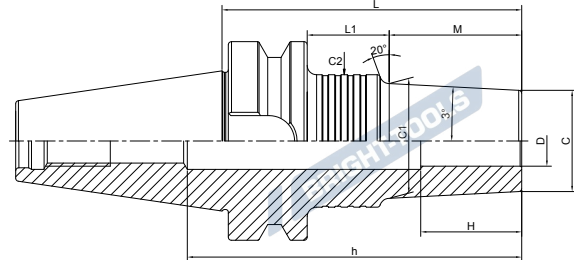

Size	D	C	L	M	L1	C1	C2	H	h
BT40-SFRB16-75-M22	16	32	75	22	26	34.3	42	32	85
BT40-SFRB16-95-M42	16	32	95	42	26	36.4	42	32	105
BT40-SFRB16-105-M22	16	32	105	22	56	34.3	42	32	115
BT40-SFRB16-120-M67	16	32	120	67	26	39	42	32	130
BT40-SFRB16-125-M42	16	32	125	42	56	36.4	42	32	135
BT40-SFRB16-150-M67	16	32	150	67	56	39	42	32	160
BT40-SFRB20-95-M42	20	38	95	42	26	42.4	53	40	105
BT40-SFRB20-120-M67	20	38	120	67	26	45	53	40	130
BT40-SFRB20-125-M42	20	38	125	42	56	42.4	53	40	135
BT40-SFRB20-150-M67	20	38	150	67	56	45	50	40	160
BT40-SFRB20-155-M42	20	38	155	42	86	42.4	53	40	165
BT40-SFRB20-180-M67	20	38	180	67	86	45	50	40	190

BRIGHT-TOOLS

BRIGHT-TOOLS

BRIGHT-TOOLS

BRIGHT-TOOLS

Shrink Chuck, 3°, Regular, Form B
热缩刀柄 3 度, 标准 B 型

A ↗ ≤0.003	RPM G2.5/25000	AD
---------------	-------------------	----

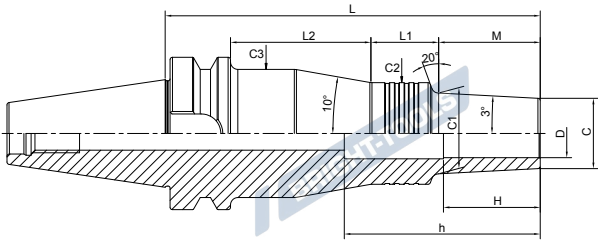

Size	D	C	L	M	L1	L2	C1	C2	C3	H	h
BT40-SFRB06-135-M22	06	14	135	22	30	56	16.3	32	46	18	170
BT40-SFRB06-155-M42	06	14	155	42	30	56	18.4	32	46	18	190
BT40-SFRB06-180-M67	06	14	180	67	30	56	21	32	46	18	215
BT40-SFRB08-135-M22	08	18	135	22	30	56	20.3	32	46	24	170
BT40-SFRB08-155-M42	08	18	155	42	30	56	22.4	32	46	24	190
BT40-SFRB08-180-M67	08	18	180	67	30	56	25	32	46	24	215
BT40-SFRB10-135-M22	10	22	135	22	30	56	24.3	32	46	30	170
BT40-SFRB10-155-M42	10	22	155	42	30	56	26.4	32	46	30	190
BT40-SFRB10-180-M67	10	22	180	67	28	58	29	42	53	30	215
BT40-SFRB12-155-M42	12	26	155	42	28	58	30.4	42	53	30	190
BT40-SFRB12-180-M67	12	26	180	67	28	58	33	42	53	30	215
BT40-SFRB16-135-M22	16	32	135	22	28	58	34.3	42	53	32	145
BT40-SFRB16-155-M42	16	32	155	42	28	58	36.4	42	53	32	165
BT40-SFRB16-180-M67	16	32	180	67	28	58	39	42	53	32	190



Shrink Chuck, 3°, Regular, Form B

热缩刀柄 3 度, 标准 B 型

A ↗ ≤0.003	RPM G2.5/25000	AD
---------------	-------------------	----

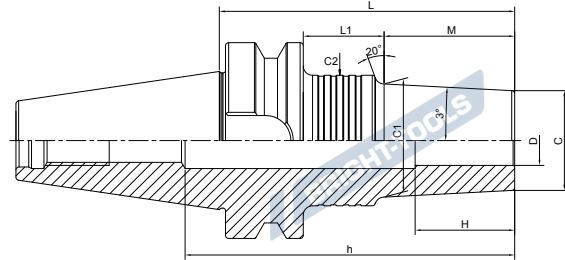

Size	D	C	L	M	L1	C1	C2	H	h
BT50-SFRB06-90-M22	06	14	90	22	30	16.3	32	18	145
BT50-SFRB06-110-M42	06	14	110	42	30	18.4	32	18	165
BT50-SFRB06-120-M22	06	14	120	22	60	16.3	32	18	175
BT50-SFRB06-135-M67	06	14	135	67	30	21	32	18	190
BT50-SFRB06-140-M42	06	14	140	42	60	18.4	32	18	195
BT50-SFRB06-165-M67	06	14	165	67	60	21	32	18	220
BT50-SFRB08-90-M22	08	18	90	22	30	20.3	32	24	145
BT50-SFRB08-110-M42	08	18	110	42	30	22.4	32	24	165
BT50-SFRB08-120-M22	08	18	120	22	60	20.3	32	24	175
BT50-SFRB08-135-M67	08	18	135	67	30	25	32	24	190
BT50-SFRB08-140-M42	08	18	140	42	60	22.4	32	24	195
BT50-SFRB08-165-M67	08	18	165	67	60	25	32	24	220
BT50-SFRB10-90-M22	10	22	90	22	30	24.3	32	30	145
BT50-SFRB10-110-M42	10	22	110	42	30	26.4	32	30	165
BT50-SFRB10-120-M22	10	22	120	22	60	24.3	32	30	175
BT50-SFRB10-135-M67	10	22	135	67	30	29	42	30	190
BT50-SFRB10-140-M42	10	22	140	42	60	26.4	32	30	195
BT50-SFRB10-165-M67	10	22	165	67	60	29	42	30	220
BT50-SFRB12-90-M22	12	26	90	22	30	28.3	42	30	145
BT50-SFRB12-110-M42	12	26	110	42	30	30.4	42	30	165
BT50-SFRB12-120-M22	12	26	120	22	60	28.3	42	30	175
BT50-SFRB12-135-M67	12	26	135	67	30	33	42	30	190
BT50-SFRB12-140-M42	12	26	140	42	60	30.4	42	30	195
BT50-SFRB12-165-M67	12	26	165	67	60	33	42	30	220

Shrink Chuck, 3°, Regular, Form B

热缩刀柄 3 度, 标准 B 型

A ↗ ≤0.003	RPM G2.5/25000	AD
---------------	-------------------	----

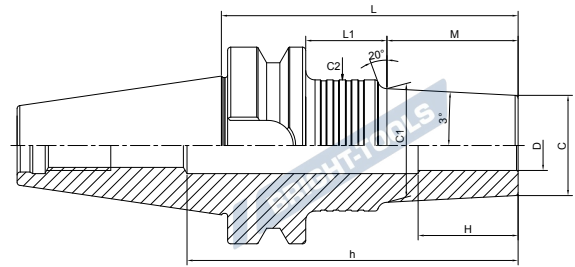

Size	D	C	L	M	L1	C1	C2	H	h
BT50-SFRB16-90-M22	16	32	90	22	30	34.3	42	32	145
BT50-SFRB16-110-M42	16	32	110	42	30	36.4	42	32	165
BT50-SFRB16-120-M22	16	32	120	22	60	34.3	42	32	175
BT50-SFRB16-135-M67	16	32	135	67	30	39	42	32	190
BT50-SFRB16-140-M42	16	32	140	42	60	36.4	42	32	195
BT50-SFRB16-165-M67	16	32	165	67	60	39	42	32	220
BT50-SFRB20-110-M42	20	38	110	42	30	42.4	53	40	165
BT50-SFRB20-135-M67	20	38	135	67	30	45	53	40	190
BT50-SFRB20-140-M42	20	38	140	42	60	42.4	53	40	195
BT50-SFRB20-165-M67	20	38	165	67	60	45	53	40	220
BT50-SFRB25-110-M42	25	45	110	42	30	49.4	53	45	165
BT50-SFRB25-140-M42	25	45	140	42	60	49.4	53	45	195
BT50-SFRB32-110-M42	32	54	110	42	30	58.4	63	50	160
BT50-SFRB32-140-M42	32	54	140	42	60	58.4	63	50	171



Shrink Chuck, 3°, Regular, Form B

热缩刀柄 3 度, 标准 B 型

A ↗ ≤0.003	RPM G2.5/25000	 AD
---------------	-------------------	--------

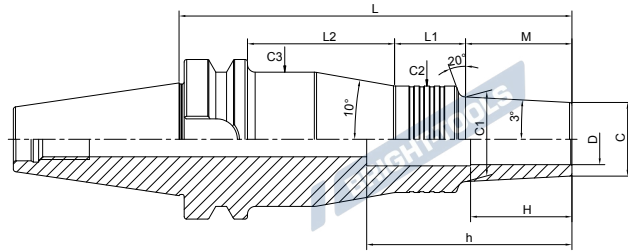

Size	D	C	L	M	L1	L2	C1	C2	C3	H	h
BT50-SFRB06-150-M22	06	14	150	22	30	60	16.3	32	46	18	205
BT50-SFRB06-170-M42	06	14	170	42	30	60	18.4	32	46	18	225
BT50-SFRB06-195-M67	06	14	195	67	30	60	21	32	46	18	250
BT50-SFRB08-150-M22	08	18	150	22	30	60	20.3	32	46	24	205
BT50-SFRB08-170-M42	08	18	170	42	28	62	22.4	36	50	24	225
BT50-SFRB08-195-M67	08	18	195	67	30	60	25	32	46	24	250
BT50-SFRB10-150-M22	10	22	150	22	30	60	24.3	32	46	30	205
BT50-SFRB10-170-M42	10	22	170	42	28	62	26.4	36	50	30	225
BT50-SFRB10-195-M67	10	22	195	67	28	62	29	42	56	30	250
BT50-SFRB12-150-M22	12	26	150	22	28	62	28.3	42	56	30	205
BT50-SFRB12-170-M42	12	26	170	42	28	62	30.4	42	56	30	225
BT50-SFRB12-195-M67	12	26	195	67	28	62	33	42	56	30	250
BT50-SFRB16-150-M22	16	32	150	22	28	62	34.3	42	56	32	205
BT50-SFRB16-170-M42	16	32	170	42	28	62	36.4	42	56	32	225
BT50-SFRB16-195-M67	16	32	195	67	28	62	39.0	42	56	32	250
BT50-SFRB20-170-M42	20	38	170	42	28	62	42.4	53	67	40	225
BT50-SFRB20-195-M67	20	38	195	67	28	62	45	53	67	40	250
BT50-SFRB25-170-M42	25	45	170	42	28	62	49.4	53	67	45	195
BT50-SFRB32-170-M42	32	54	170	42	28	62	58.4	63	77	50	171

Shrink Chuck, 3°, Regular, Form B

热缩刀柄 3 度, 标准 B 型



A ↗	RPM	
≤0.003	G2.5/25000	AD

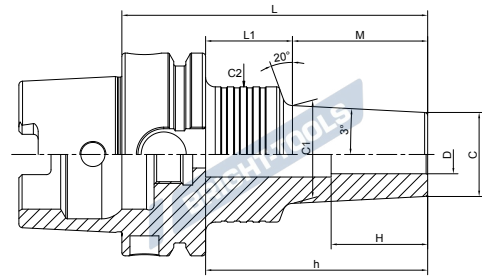

Size	D	C	L	M	L1	C1	C2	H	h
HSK50A-SFRB06-75-M22	06	14	75	22	27	16.3	32	18	50
HSK50A-SFRB06-95-M42	06	14	95	42	27	18.4	32	18	70
HSK50A-SFRB06-125-M42	06	14	125	42	57	18.4	32	18	100
HSK50A-SFRB08-75-M22	08	18	75	22	27	20.3	32	24	50
HSK50A-SFRB08-95-M42	08	18	95	42	27	22.4	32	24	70
HSK50A-SFRB08-125-M42	08	18	125	42	57	22.4	32	24	100
HSK50A-SFRB10-75-M22	10	22	75	22	27	24.3	32	30	50
HSK50A-SFRB10-95-M42	10	22	95	42	27	26.4	32	30	70
HSK50A-SFRB10-125-M42	10	22	125	42	57	26.4	32	30	100
HSK50A-SFRB12-75-M42	12	26	75	22	27	28.3	42	30	52
HSK50A-SFRB12-95-M42	12	26	95	42	27	30.4	42	30	72
HSK50A-SFRB12-125-M42	12	26	125	42	57	30.4	42	30	98
HSK50A-SFRB16-75-M22	16	32	75	22	27	34.3	42	32	52
HSK50A-SFRB16-105-M22	16	32	105	22	57	34.3	42	32	78
HSK50A-SFRB20-75-M22	20	38	75	22	27	40.3	49	40	51
HSK50A-SFRB20-105-M22	20	38	105	22	57	40.3	49	40	76



Shrink Chuck, 3°, Regular, Form B
热缩刀柄 3 度, 标准 B 型

A ↗ ≤0.003	RPM G2.5/25000	AD
---------------	-------------------	----

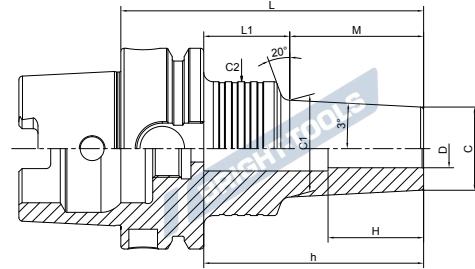

Size	D	C	L	M	L1	C1	C2	H	h
HSK63A-SFRB06-75-M22	06	14	75	22	27	16.3	32	18	49
HSK63A-SFRB06-95-M42	06	14	95	42	27	18.4	32	18	69
HSK63A-SFRB06-105-M22	06	14	105	22	57	16.3	32	18	79
HSK63A-SFRB06-120-M67	06	14	120	67	27	21	32	18	94
HSK63A-SFRB06-125-M42	06	14	125	42	57	18.4	32	18	99
HSK63A-SFRB06-150-M67	06	14	150	67	57	21	32	18	124
HSK63A-SFRB08-75-M22	08	18	75	22	27	20.3	32	24	49
HSK63A-SFRB08-95-M42	08	18	95	42	27	22.4	32	24	69
HSK63A-SFRB08-105-M22	08	18	105	22	57	20.3	32	24	79
HSK63A-SFRB08-120-M67	08	18	120	67	27	25	32	24	94
HSK63A-SFRB08-125-M42	08	18	125	42	57	22.4	32	24	99
HSK63A-SFRB08-150-M67	08	18	150	67	57	25	32	24	124
HSK63A-SFRB10-75-M22	10	22	75	22	27	24.3	32	30	49
HSK63A-SFRB10-95-M42	10	22	95	42	27	26.4	32	30	68
HSK63A-SFRB10-105-M22	10	22	105	22	57	24.3	32	30	79
HSK63A-SFRB10-120-M67	10	22	120	67	27	29	42	30	94
HSK63A-SFRB10-125-M42	10	22	125	42	57	26.4	32	30	99
HSK63A-SFRB10-150-M67	10	22	150	67	57	29	42	30	124
HSK63A-SFRB12-75-M22	12	26	75	22	27	28.3	42	30	50
HSK63A-SFRB12-95-M42	12	26	95	42	27	30.4	42	30	70
HSK63A-SFRB12-105-M22	12	26	105	22	57	28.3	42	30	77
HSK63A-SFRB12-120-M67	12	26	120	67	27	33	42	30	95
HSK63A-SFRB12-125-M42	12	26	125	42	57	30.4	42	30	97
HSK63A-SFRB12-150-M67	12	26	150	67	57	33	42	30	122
HSK63A-SFRB12-155-M42	12	26	155	42	87	30.4	50	30	125

Shrink Chuck, 3°, Regular, Form B
热缩刀柄 3 度, 标准 B 型

A ↗ ≤0.003	RPM G2.5/25000	AD
---------------	-------------------	----

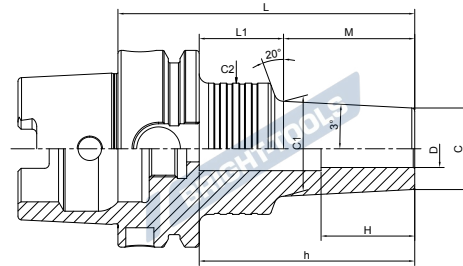

Size	D	C	L	M	L1	C1	C2	H	h
HSK63A-SFRB16-75-M22	16	32	75	22	27	34.3	42	32	50
HSK63A-SFRB16-95-M42	16	32	95	42	27	36.4	42	32	70
HSK63A-SFRB16-105-M22	16	32	105	22	57	34.3	42	32	77
HSK63A-SFRB16-120-M67	16	32	120	67	27	39	42	32	95
HSK63A-SFRB16-125-M42	16	32	125	42	57	36.4	42	32	97
HSK63A-SFRB16-150-M67	16	32	150	67	57	39	42	32	122
HSK63A-SFRB20-95-M42	20	38	95	42	27	42.4	53	40	70
HSK63A-SFRB20-120-M67	20	38	120	67	27	45	53	40	95
HSK63A-SFRB20-125-M42	20	38	125	42	57	42.4	53	40	96
HSK63A-SFRB20-150-M67	20	38	150	67	57	45	53	40	120
HSK63A-SFRB20-155-M42	20	38	155	42	87	42.4	53	40	125
HSK63A-SFRB20-180-M67	20	38	180	67	87	45	53	40	150
HSK63A-SFRB25-95-M42	25	45	95	42	27	49.4	53	45	70
HSK63A-SFRB25-125-M42	25	45	125	42	57	49.4	53	45	96
HSK63A-SFRB25-155-M42	25	45	155	42	87	49.4	53	45	126
HSK63A-SFRB32-110-M42	32	54	110	42	42	58.4	63	50	84



Shrink Chuck, 3°, Regular, Form B
热缩刀柄 3 度, 标准 B 型

A ↗ ≤0.003	RPM G2.5/25000	AD
---------------	-------------------	----

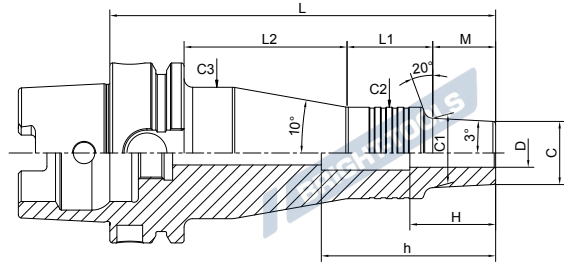

Size	D	C	L	M	L1	L2	C1	C2	C3	H	h
HSK63A-SFRB06-135-M22	06	14	135	22	30	57	16.3	32	46	18	109
HSK63A-SFRB06-155-M42	06	14	155	42	30	57	18.4	32	46	18	129
HSK63A-SFRB06-180-M67	06	14	180	67	30	57	21	32	46	18	154
HSK63A-SFRB08-135-M22	08	18	135	22	30	57	20.3	32	46	24	109
HSK63A-SFRB08-155-M42	08	18	155	42	30	57	22.4	32	46	24	129
HSK63A-SFRB08-180-M67	08	18	180	67	30	57	25	32	46	24	155
HSK63A-SFRB10-135-M22	10	22	135	22	30	57	24.3	32	46	30	109
HSK63A-SFRB10-155-M42	10	22	155	42	30	57	26.4	32	46	30	129
HSK63A-SFRB10-180-M67	10	22	180	67	28	59	29	42	53	30	154
HSK63A-SFRB12-135-M22	12	26	135	22	28	59	28.3	42	53	30	107
HSK63A-SFRB12-180-M67	12	26	180	67	28	59	33	42	53	30	152
HSK63A-SFRB16-135-M22	16	32	135	22	28	59	34.3	42	53	32	107
HSK63A-SFRB16-155-M42	16	32	155	42	28	59	36.4	42	53	32	127
HSK63A-SFRB16-180-M67	16	32	180	67	28	59	39	42	53	32	152

Shrink Chuck, 3°, Regular, Form B

热缩刀柄 3 度, 标准 B 型



A ↗ ≤0.003	RPM G2.5/25000	AD
---------------	-------------------	----

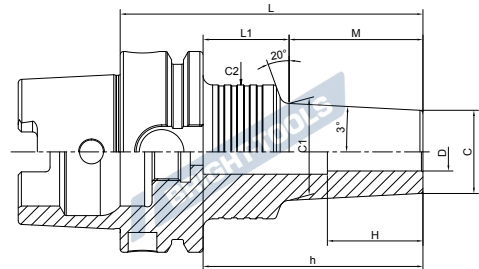

Size	D	C	L	M	L1	C1	C2	H	h
HSK100A-SFRB06-90-M22	06	14	90	22	39	16.3	32	18	61
HSK100A-SFRB06-110-M42	06	14	110	42	39	18.4	32	18	81
HSK100A-SFRB06-120-M22	06	14	120	22	69	16.3	32	18	91
HSK100A-SFRB06-135-M67	06	14	135	67	39	21	32	18	106
HSK100A-SFRB06-140-M42	06	14	140	42	69	18.4	32	18	111
HSK100A-SFRB06-165-M67	06	14	165	67	69	21	32	18	136
HSK100A-SFRB08-90-M22	08	18	90	22	39	20.3	32	24	61
HSK100A-SFRB08-110-M42	08	18	110	42	39	22.4	32	24	81
HSK100A-SFRB08-120-M22	08	18	120	22	69	20.3	32	24	91
HSK100A-SFRB08-135-M67	08	18	135	67	39	25	32	24	106
HSK100A-SFRB08-140-M42	08	18	140	42	69	22.4	32	24	111
HSK100A-SFRB08-165-M67	08	18	165	67	69	25	32	24	136
HSK100A-SFRB10-90-M22	10	22	90	22	39	24.3	32	30	61
HSK100A-SFRB10-110-M42	10	22	110	42	39	26.4	32	30	81
HSK100A-SFRB10-120-M22	10	22	120	22	69	24.3	32	30	91
HSK100A-SFRB10-135-M67	10	22	135	67	39	29	42	30	106
HSK100A-SFRB10-140-M42	10	22	140	42	69	26.4	32	30	111
HSK100A-SFRB10-165-M67	10	22	165	67	69	29	36	30	135
HSK100A-SFRB12-90-M22	12	26	90	22	39	28.3	42	30	58
HSK100A-SFRB12-110-M42	12	26	110	42	39	30.4	42	30	78
HSK100A-SFRB12-120-M22	12	26	120	22	69	28.3	42	30	87
HSK100A-SFRB12-135-M67	12	26	135	67	39	33	42	30	103
HSK100A-SFRB12-140-M42	12	26	140	42	69	30.4	42	30	107
HSK100A-SFRB12-150-M22	12	26	150	22	99	28.3	50	30	117
HSK100A-SFRB12-165-M67	12	26	165	67	69	33	42	30	132
HSK100A-SFRB12-170-M42	12	26	170	42	99	30.4	50	30	135



Shrink Chuck, 3°, Regular, Form B
热缩刀柄 3 度, 标准 B 型

A ↗ ≤0.003	RPM G2.5/25000	AD
---------------	-------------------	----

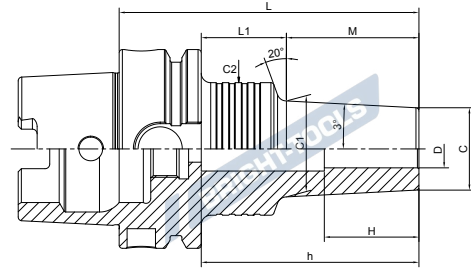

Size	D	C	L	M	L1	C1	C2	H	h
HSK100A-SFRB16-90-M22	16	32	90	22	39	34.3	42	32	58
HSK100A-SFRB16-110-M42	16	32	110	42	39	36.4	42	32	78
HSK100A-SFRB16-120-M22	16	32	120	22	69	34.3	42	32	87
HSK100A-SFRB16-135-M67	16	32	135	67	39	39	42	32	103
HSK100A-SFRB16-140-M42	16	32	140	42	69	36.4	42	32	107
HSK100A-SFRB16-150-M22	16	32	150	22	99	34.3	50	32	115
HSK100A-SFRB16-165-M67	16	32	165	67	69	39	42	32	132
HSK100A-SFRB20-110-M42	20	38	110	42	39	42.4	53	40	78
HSK100A-SFRB20-135-M67	20	38	135	67	39	45	53	40	103
HSK100A-SFRB20-140-M42	20	38	140	42	69	42.4	53	40	105
HSK100A-SFRB20-165-M67	20	38	165	67	69	45	53	40	130
HSK100A-SFRB25-110-M42	25	45	110	42	39	49.6	53	45	78
HSK100A-SFRB25-140-M42	25	45	140	42	69	49.6	50	45	105
HSK100A-SFRB32-110-M42	32	54	110	42	39	58.4	63	50	77
HSK100A-SFRB32-140-M42	32	54	140	42	69	58.4	63	50	107

Shrink Chuck, 3°, Regular, Form B
热缩刀柄 3 度, 标准 B 型



A ↗ ≤0.003	RPM G2.5/25000	AD
---------------	-------------------	----

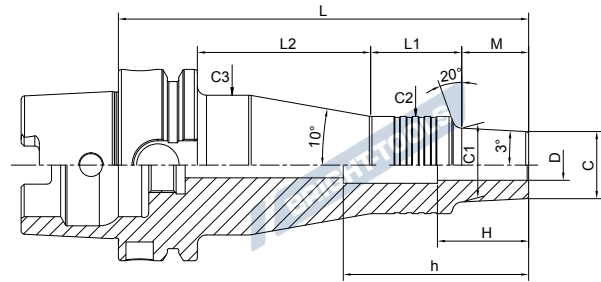

Size	D	C	L	M	L1	L2	C1	C2	C3	H	h
HSK100A-SFRB06-150-M22	06	14	150	22	30	69	16.3	32	46	18	121
HSK100A-SFRB06-170-M42	06	14	170	42	30	69	18.4	32	46	18	141
HSK100A-SFRB06-195-M67	06	14	195	67	30	69	21	32	46	18	168
HSK100A-SFRB08-150-M22	08	18	150	22	30	69	20.3	32	46	24	121
HSK100A-SFRB08-170-M42	08	18	170	42	28	71	22.4	36	50	24	140
HSK100A-SFRB08-195-M67	08	18	195	67	30	69	25	32	46	24	166
HSK100A-SFRB10-150-M22	10	22	150	22	28	71	24.3	36	50	30	120
HSK100A-SFRB10-170-M42	10	22	170	42	28	71	26.4	36	50	30	140
HSK100A-SFRB10-195-M67	10	22	195	67	28	71	29	42	56	30	166
HSK100A-SFRB12-195-M67	12	26	195	67	28	71	33	42	56	30	162
HSK100A-SFRB16-170-M42	16	32	170	42	28	71	36.4	42	56	32	137
HSK100A-SFRB16-195-M67	16	32	195	67	28	71	39	42	56	32	162
HSK100A-SFRB20-170-M42	20	38	170	42	28	71	42.4	53	67	40	135
HSK100A-SFRB20-195-M67	20	38	195	67	28	71	45	53	67	40	160
HSK100A-SFRB25-170-M42	25	45	170	42	28	71	49.6	53	67	45	135
HSK100A-SFRB32-170-M42	32	54	170	42	28	71	58.4	63	77	50	132



Shrink Chuck, 3°, Regular, Form B
热缩刀柄 3 度, 标准 B 型

 A ↗
 ≤0.003

 RPM
 G2.5/25000

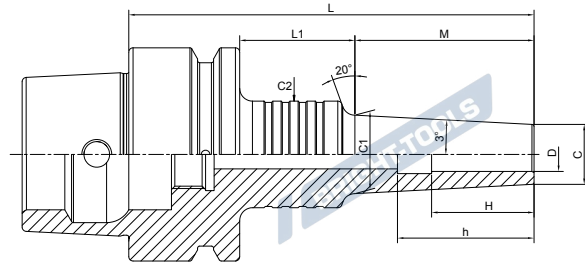

 AD

Size	D	C	L	M	L1	C1	C2	H	h
HSK50E-SFRB06-95-M42	06	14	95	42	27	18.4	32	18	80
HSK50E-SFRB08-95-M42	08	18	95	42	27	22.4	32	24	80
HSK50E-SFRB08-120-M67	08	18	120	67	27	25	32	24	105
HSK50E-SFRB10-95-M42	10	22	95	42	27	26.4	32	30	80
HSK50E-SFRB10-120-M67	10	22	120	67	27	29	42	30	107
HSK50E-SFRB12-95-M42	12	26	95	42	27	30.4	42	30	82
HSK50E-SFRB12-120-M67	12	26	120	67	27	33	42	30	107
HSK50E-SFRB16-75-M22	16	32	75	22	27	34.3	42	32	62

Shrink Chuck, 3°, Regular, Coolant

热缩刀柄 3 度, 端面出水型

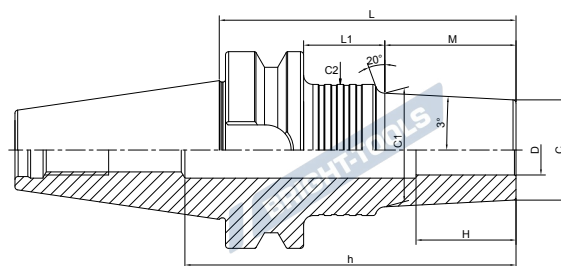
A ↗ ≤0.003	RPM G2.5/25000	AD
---------------	-------------------	----



Size	D	C	L	M	L1	C1	C2	H	h
BT40-SFFB03-75-M22	03	9.5	75	22	26	11.8	25	9	110
BT40-SFFB03-95-M42	03	9.5	95	42	26	13.9	25	9	130
BT40-SFFB03-105-M22	03	9.5	105	22	56	11.8	25	9	140
BT40-SFFB03-120-M67	03	9.5	120	67	26	16.5	25	9	155
BT40-SFFB03-125-M42	03	9.5	125	42	56	13.9	25	9	160
BT40-SFFB03-150-M67	03	9.5	150	67	56	16.5	25	9	185
BT40-SFFB04-75-M22	04	12	75	22	26	14.3	25	12	110
BT40-SFFB04-95-M42	04	12	95	42	26	16.4	25	12	130
BT40-SFFB04-105-M22	04	12	105	22	56	14.3	25	12	140
BT40-SFFB04-120-M67	04	12	120	67	26	19	25	12	155
BT40-SFFB04-125-M42	04	12	125	42	56	16.4	25	12	160
BT40-SFFB04-150-M67	04	12	150	67	56	19	25	12	185
BT40-SFFB06-75-M22	06	14	75	22	26	16.3	32	18	110
BT40-SFFB06-95-M42	06	14	95	42	26	18.4	32	18	130
BT40-SFFB06-105-M22	06	14	105	22	56	16.3	32	18	140
BT40-SFFB06-120-M67	06	14	120	67	26	21	32	18	155
BT40-SFFB06-125-M42	06	14	125	42	56	18.4	32	18	160
BT40-SFFB06-150-M67	06	14	150	67	56	21	32	18	185
BT40-SFFB08-75-M22	08	18	75	22	26	20.3	32	24	110
BT40-SFFB08-95-M42	08	18	95	42	26	22.4	32	24	130
BT40-SFFB08-105-M22	08	18	105	22	56	20.3	32	24	140
BT40-SFFB08-120-M67	08	18	120	67	26	25	32	24	155
BT40-SFFB08-125-M42	08	18	125	42	56	22.4	32	24	160
BT40-SFFB08-150-M67	08	18	150	67	56	25	32	24	185
BT40-SFFB10-75-M22	10	22	75	22	26	24.3	32	30	110
BT40-SFFB10-95-M42	10	22	95	42	26	26.4	32	30	130
BT40-SFFB10-105-M22	10	22	105	22	56	24.3	32	30	140
BT40-SFFB10-120-M67	10	22	120	67	26	29	42	30	155
BT40-SFFB10-125-M42	10	22	125	42	56	26.4	32	30	160
BT40-SFFB10-150-M67	10	22	150	67	56	29	42	30	185

Shrink Chuck, 3°, Regular, Coolant

热缩刀柄 3 度, 端面出水型

A ↗ ≤0.003	RPM G2.5/25000	AD
---------------	-------------------	----

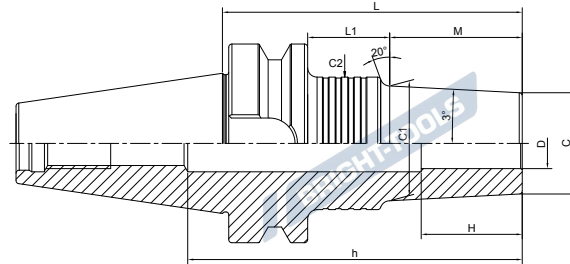

Size	D	C	L	M	L1	C1	C2	H	h
BT40-SFFB12-75-M22	12	26	75	22	26	28.3	42	30	110
BT40-SFFB12-95-M42	12	26	95	42	26	30.4	42	30	130
BT40-SFFB12-105-M22	12	26	105	22	56	28.3	42	30	140
BT40-SFFB12-120-M67	12	26	120	67	26	33	42	30	155
BT40-SFFB12-125-M42	12	26	125	42	56	30.4	42	30	160
BT40-SFFB12-150-M67	12	26	150	67	56	33	42	30	185
BT40-SFFB12-155-M42	12	26	155	42	86	30.4	50	30	190
BT40-SFFB12-180-M67	12	26	180	67	86	33	50	30	215
BT40-SFFB16-75-M22	16	32	75	22	26	34.3	42	32	85
BT40-SFFB16-95-M42	16	32	95	42	26	36.4	42	32	105
BT40-SFFB16-105-M22	16	32	105	22	56	34.3	42	32	115
BT40-SFFB16-120-M67	16	32	120	67	26	39	42	32	130
BT40-SFFB16-125-M42	16	32	125	42	56	36.4	42	32	135
BT40-SFFB16-135-M22	16	32	135	22	86	34.3	50	32	145
BT40-SFFB16-150-M67	16	32	150	67	56	39	42	32	160
BT40-SFFB16-155-M42	16	32	155	42	86	36.4	50	32	165
BT40-SFFB16-180-M67	16	32	180	67	86	39	50	32	190
BT40-SFFB20-95-M42	20	38	95	42	26	42.4	53	40	105
BT40-SFFB20-120-M67	20	38	120	67	26	45	53	40	130
BT40-SFFB20-125-M42	20	38	125	42	56	42.4	53	40	135
BT40-SFFB20-150-M67	20	38	150	67	56	45	50	40	160
BT40-SFFB20-155-M42	20	38	155	42	86	42.4	50	40	165
BT40-SFFB20-180-M67	20	38	180	67	86	45	50	40	190
BT40-SFFB25-95-M42	25	45	95	42	26	49.4	53	45	105
BT40-SFFB25-125-M42	25	45	125	42	56	49.4	53	45	135
BT40-SFFB25-155-M42	25	45	155	42	86	49.4	53	45	165

Shrink Chuck, 3°, Regular, Coolant
 热缩刀柄 3 度, 端面出水型

A ↗ ≤0.003	RPM G2.5/25000	AD
---------------	-------------------	----

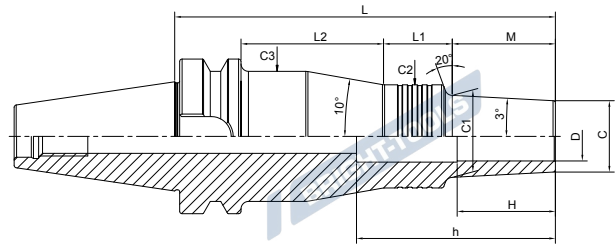

Size	D	C	L	M	L1	L2	C1	C2	C3	H	h
BT40-SFFB03-135-M22	03	9.5	135	22	33	53	11.8	25	39	9	170
BT40-SFFB03-155-M42	03	9.5	155	42	33	53	13.9	25	39	9	190
BT40-SFFB03-180-M67	03	9.5	180	67	33	53	16.5	26	40	9	215
BT40-SFFB04-135-M22	04	12	135	22	33	53	14.3	25	39	12	170
BT40-SFFB04-155-M42	04	12	155	42	33	53	16.4	25	39	12	190
BT40-SFFB04-180-M67	04	12	180	67	33	53	19	25	39	12	215
BT40-SFFB06-135-M22	06	14	135	22	30	56	16.3	32	46	18	170
BT40-SFFB06-155-M42	06	14	155	42	30	56	18.4	32	46	18	190
BT40-SFFB06-180-M67	06	14	180	67	30	56	21	36	46	18	215
BT40-SFFB08-135-M22	08	18	135	22	30	56	20.3	32	46	24	170
BT40-SFFB08-155-M42	08	18	155	42	30	56	22.4	32	46	24	190
BT40-SFFB08-180-M67	08	18	180	67	28	58	25	36	50	24	215
BT40-SFFB10-135-M22	10	22	135	22	30	56	24.3	32	46	30	170
BT40-SFFB10-155-M42	10	22	155	42	28	58	26.4	36	50	30	190
BT40-SFFB10-180-M67	10	22	180	67	28	58	29	36	50	30	215
BT40-SFFB12-135-M22	12	26	135	22	28	58	28.3	42	53	30	145

Shrink Chuck, 3°, Regular, Coolant

热缩刀柄 3 度, 端面出水型

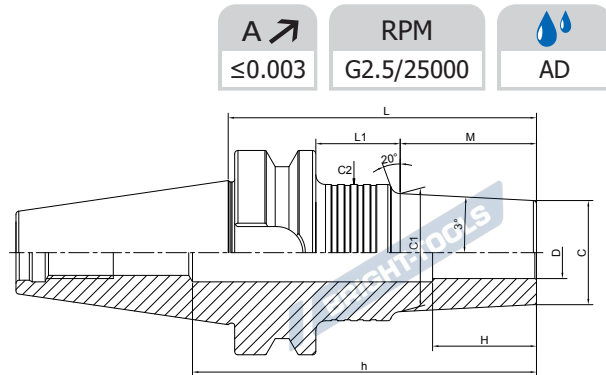

Size	D	C	L	M	L1	C1	C2	H	h
BT50-SFFB03-90-M22	03	9.5	90	22	30	11.8	26	9	145
BT50-SFFB03-110-M42	03	9.5	110	42	30	13.9	26	9	165
BT50-SFFB03-120-M22	03	9.5	120	22	60	11.8	25	9	175
BT50-SFFB03-135-M67	03	9.5	135	67	30	16.5	26	9	190
BT50-SFFB03-140-M42	03	9.5	140	42	60	13.9	25	9	195
BT50-SFFB03-165-M67	03	9.5	165	67	60	16.5	26	9	220
BT50-SFFB04-90-M22	04	12	90	22	30	14.3	26	12	145
BT50-SFFB04-110-M42	04	12	110	42	30	16.4	26	12	165
BT50-SFFB04-120-M22	04	12	120	22	60	14.3	25	12	175
BT50-SFFB04-135-M67	04	12	135	67	30	19	26	12	190
BT50-SFFB04-140-M42	04	12	140	42	60	16.4	26	12	195
BT50-SFFB04-165-M67	04	12	165	67	60	19	26	12	220
BT50-SFFB06-90-M22	06	14	90	22	30	16.3	32	18	145
BT50-SFFB06-110-M42	06	14	110	42	30	18.4	32	18	165
BT50-SFFB06-120-M22	06	14	120	22	60	16.3	32	18	175
BT50-SFFB06-135-M67	06	14	135	67	30	21	32	18	190
BT50-SFFB06-140-M42	06	14	140	42	60	18.4	32	18	195
BT50-SFFB06-165-M67	06	14	165	67	60	21	32	18	220
BT50-SFFB08-90-M22	08	18	90	22	30	20.3	32	24	145
BT50-SFFB08-110-M42	08	18	110	42	30	22.4	32	24	165
BT50-SFFB08-120-M22	08	18	120	22	60	20.3	32	24	175
BT50-SFFB08-135-M67	08	18	135	67	30	25	32	24	190
BT50-SFFB08-140-M42	08	18	140	42	60	22.4	32	24	195
BT50-SFFB08-165-M67	08	18	165	67	60	25	32	24	220
BT50-SFFB10-90-M22	10	22	90	22	30	24.3	32	30	145
BT50-SFFB10-110-M42	10	22	110	42	30	26.4	32	30	165
BT50-SFFB10-120-M22	10	22	120	22	60	24.3	32	30	175
BT50-SFFB10-135-M67	10	22	135	67	30	29	42	30	190
BT50-SFFB10-140-M42	10	22	140	42	60	26.4	36	30	195
BT50-SFFB10-165-M67	10	22	165	67	60	29	42	30	220

Shrink Chuck, 3°, Regular, Coolant
热缩刀柄 3 度, 端面出水型

A ↗ ≤0.003	RPM G2.5/25000	AD
---------------	-------------------	----

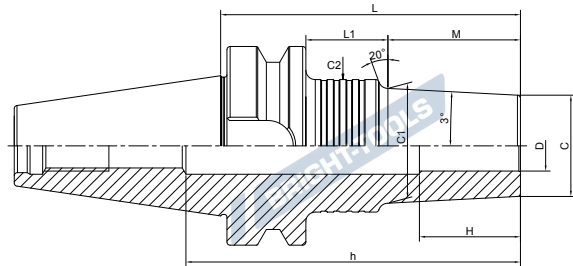

Size	D	C	L	M	L1	C1	C2	H	h
BT50-SFFB12-90-M22	12	26	90	22	30	28.3	42	30	145
BT50-SFFB12-110-M42	12	26	110	42	30	30.4	42	30	165
BT50-SFFB12-120-M22	12	26	120	22	60	28.3	42	30	175
BT50-SFFB12-135-M67	12	26	135	67	30	33	42	30	190
BT50-SFFB12-140-M42	12	26	140	42	60	30.4	42	30	195
BT50-SFFB12-165-M67	12	26	165	67	60	33	42	30	220
BT50-SFFB16-90-M22	16	32	90	22	30	34.3	42	32	145
BT50-SFFB16-110-M42	16	32	110	42	30	36.4	42	32	165
BT50-SFFB16-120-M22	16	32	120	22	60	34.3	42	32	175
BT50-SFFB16-135-M67	16	32	135	67	30	39	42	32	190
BT50-SFFB16-140-M42	16	32	140	42	60	36.4	42	32	195
BT50-SFFB16-165-M67	16	32	165	67	60	39	42	32	220
BT50-SFFB20-110-M42	20	38	110	42	30	42.4	53	40	165
BT50-SFFB20-135-M67	20	38	135	67	30	45	53	40	190
BT50-SFFB20-140-M42	20	38	140	42	60	42.4	53	40	195
BT50-SFFB20-165-M67	20	38	165	67	60	45	53	40	220
BT50-SFFB25-110-M42	25	45	110	42	30	49.4	53	45	165
BT50-SFFB25-140-M42	25	45	140	42	60	49.4	53	45	195



Shrink Chuck, 3°, Regular, Coolant

热缩刀柄 3 度, 端面出水型

A ↗ ≤0.003	RPM G2.5/25000	AD
---------------	-------------------	----

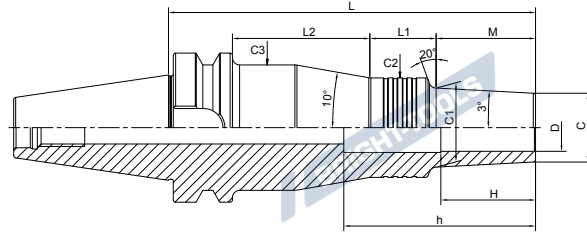

Size	D	C	L	M	L1	L2	C1	C2	C3	H	h
BT50-SFFB03-150-M22	03	9.5	150	22	33	57	11.8	25	39	9	205
BT50-SFFB03-170-M42	03	9.5	170	42	33	57	13.9	25	39	9	225
BT50-SFFB03-195-M67	03	9.5	195	67	33	57	16.5	25	39	9	250
BT50-SFFB04-150-M22	04	12	150	22	33	57	14.3	25	39	12	205
BT50-SFFB04-170-M42	04	12	170	42	33	57	16.4	26	40	12	225
BT50-SFFB04-195-M67	04	12	195	67	33	57	19	26	40	12	250
BT50-SFFB06-150-M22	06	14	150	22	30	60	16.3	32	46	18	205
BT50-SFFB06-170-M42	06	14	170	42	30	60	18.4	32	46	18	225
BT50-SFFB06-195-M67	06	14	195	67	30	60	21	32	46	18	250
BT50-SFFB08-150-M22	08	18	150	22	30	60	20.3	32	46	24	205
BT50-SFFB08-170-M42	08	18	170	42	30	60	22.4	32	46	24	225
BT50-SFFB08-195-M67	08	18	195	67	30	60	25	32	46	24	250
BT50-SFFB10-150-M22	10	22	150	22	30	60	24.3	32	46	30	205
BT50-SFFB10-170-M42	10	22	170	42	30	60	26.4	32	46	30	225
BT50-SFFB10-195-M67	10	22	195	67	28	62	29	42	56	30	250
BT50-SFFB12-150-M22	12	26	150	22	28	62	28.3	42	56	30	205
BT50-SFFB12-170-M42	12	26	170	42	28	62	30.4	42	56	30	225
BT50-SFFB12-195-M67	12	26	195	67	28	62	33	42	56	30	250
BT50-SFFB16-150-M22	16	32	150	22	28	62	34.3	42	56	32	205
BT50-SFFB16-170-M42	16	32	170	42	28	62	36.4	42	56	32	225
BT50-SFFB16-195-M67	16	32	195	67	28	62	39	42	56	32	250
BT50-SFFB20-170-M42	20	38	170	42	28	62	42.4	53	67	40	225
BT50-SFFB20-195-M67	20	38	195	67	28	62	45	53	67	40	250
BT50-SFFB25-170-M42	25	45	170	42	28	62	49.4	53	67	45	195

Shrink Chuck, 3°, Regular, Coolant
热缩刀柄 3 度, 端面出水型

A ↗ ≤0.003	RPM G2.5/25000	AD
---------------	-------------------	----

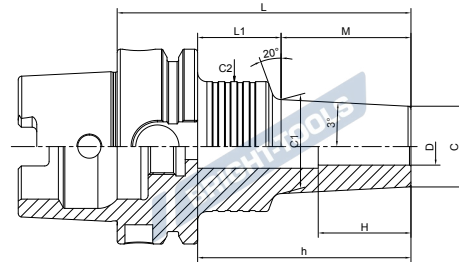

Size	D	C	L	M	L1	C1	C2	H	h
HSK40A-SFFB03-65-M22	03	9.5	65	22	23	11.8	25	9	44
HSK40A-SFFB03-85-M42	03	9.5	85	42	23	13.9	25	9	64
HSK40A-SFFB04-65-M22	04	12	65	22	23	14.3	25	12	44
HSK40A-SFFB04-85-M42	04	12	85	42	23	16.4	25	12	64
HSK40A-SFFB06-70-M22	06	14	70	22	28	16.3	32	18	48
HSK40A-SFFB06-90-M42	06	14	90	42	28	18.4	32	18	68
HSK40A-SFFB08-70-M22	08	18	70	22	28	20.3	32	24	48
HSK40A-SFFB08-90-M42	08	18	90	42	28	22.4	32	24	68
HSK40A-SFFB10-70-M22	10	22	70	22	28	24.3	32	30	48
HSK40A-SFFB10-90-M42	10	22	90	42	28	26.4	32	30	68
HSK40A-SFFB12-70-M22	12	26	70	22	28	28.3	32	30	48

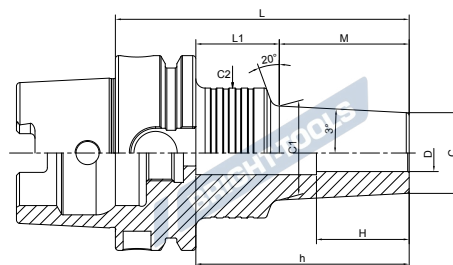
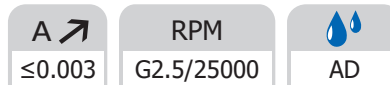

Shrink Chuck, 3°, Regular, Coolant
热缩刀柄 3 度, 端面出水型

Size	D	C	L	M	L1	C1	C2	H	h
HSK63A-SFFB03-75-M22	03	9.5	75	22	27	11.8	25	9	50
HSK63A-SFFB03-95-M42	03	9.5	95	42	27	13.9	25	9	70
HSK63A-SFFB03-105-M22	03	9.5	105	22	57	11.8	26	9	80
HSK63A-SFFB03-120-M67	03	9.5	120	67	27	16.5	26	9	95
HSK63A-SFFB03-125-M42	03	9.5	125	42	57	13.9	26	9	100
HSK63A-SFFB03-150-M67	03	9.5	150	67	57	16.5	26	9	125
HSK63A-SFFB04-75-M22	04	12	75	22	27	14.3	25	12	50
HSK63A-SFFB04-95-M42	04	12	95	42	27	16.4	25	12	70
HSK63A-SFFB04-105-M22	04	12	105	22	57	14.3	25	12	80
HSK63A-SFFB04-120-M67	04	12	120	67	27	19	25	12	95
HSK63A-SFFB04-125-M42	04	12	125	42	57	16.4	25	12	100
HSK63A-SFFB04-150-M67	04	12	150	67	57	19	25	12	125
HSK63A-SFFB06-75-M22	06	14	75	22	27	16.3	32	18	49
HSK63A-SFFB06-95-M42	06	14	95	42	27	18.4	32	18	69
HSK63A-SFFB06-105-M22	06	14	105	22	57	16.3	32	18	79
HSK63A-SFFB06-120-M67	06	14	120	67	27	21	32	18	64
HSK63A-SFFB06-125-M42	06	14	125	42	57	18.4	32	18	99
HSK63A-SFFB06-150-M67	06	14	150	67	57	21	32	18	124
HSK63A-SFFB08-75-M22	08	18	75	22	27	20.3	32	24	49
HSK63A-SFFB08-95-M42	08	18	95	42	27	22.4	32	24	69
HSK63A-SFFB08-105-M22	08	18	105	22	57	20.3	32	24	79
HSK63A-SFFB08-120-M67	08	18	120	67	27	25	32	24	94
HSK63A-SFFB08-125-M42	08	18	125	42	57	22.4	32	24	99
HSK63A-SFFB08-150-M67	08	18	150	67	57	25	32	24	124
HSK63A-SFFB10-75-M22	10	22	75	22	27	24.3	32	30	49
HSK63A-SFFB10-95-M42	10	22	95	42	27	26.4	32	30	69
HSK63A-SFFB10-105-M22	10	22	105	22	57	24.3	32	30	79
HSK63A-SFFB10-120-M67	10	22	120	67	27	29	42	30	94
HSK63A-SFFB10-125-M42	10	22	125	42	57	26.4	32	30	99
HSK63A-SFFB10-150-M67	10	22	150	67	57	29	42	30	124

Shrink Chuck, 3°, Regular, Coolant
热缩刀柄 3 度, 端面出水型



A ↗ ≤0.003	RPM G2.5/25000	AD
----------------------	--------------------------	-----------

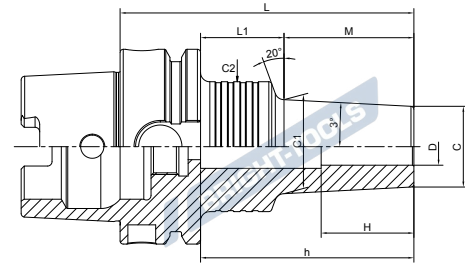

Size	D	C	L	M	L1	C1	C2	H	h
HSK63A-SFFB12-75-M22	12	26	75	22	27	28.3	42	30	50
HSK63A-SFFB12-95-M42	12	26	95	42	27	30.4	42	30	70
HSK63A-SFFB12-105-M22	12	26	105	22	57	28.3	42	30	77
HSK63A-SFFB12-120-M67	12	26	120	67	27	33	42	30	95
HSK63A-SFFB12-125-M42	12	26	125	42	57	30.4	42	30	97
HSK63A-SFFB12-150-M67	12	26	150	67	57	33	42	30	122
HSK63A-SFFB12-155-M42	12	26	155	42	86	30.4	50	30	125
HSK63A-SFFB16-75-M22	16	32	75	22	27	34.3	42	32	50
HSK63A-SFFB16-95-M42	16	32	95	42	27	36.4	42	32	70
HSK63A-SFFB16-105-M22	16	32	105	22	57	34.3	42	32	77
HSK63A-SFFB16-120-M67	16	32	120	67	27	39	42	32	95
HSK63A-SFFB16-125-M42	16	32	125	42	57	36.4	42	32	97
HSK63A-SFFB16-135-M22	16	32	135	22	28	34.3	42	32	107
HSK63A-SFFB16-150-M67	16	32	150	67	57	39	50	32	120
HSK63A-SFFB16-155-M42	16	32	155	42	86	36.4	50	32	125
HSK63A-SFFB20-95-M42	20	38	95	42	27	42.4	53	40	70
HSK63A-SFFB20-120-M67	20	38	120	67	27	45	53	40	95
HSK63A-SFSA10-125-M42	20	38	125	42	57	42.4	53	40	96
HSK63A-SFFB20-150-M67	20	38	150	67	57	45	50	40	120
HSK63A-SFFB20-155-M42	20	38	155	42	87	42.4	50	40	125
HSK63A-SFFB20-180-M67	20	38	180	67	87	45	50	40	180
HSK63A-SFFB25-95-M42	25	45	95	42	27	49.4	53	45	70
HSK63A-SFFB25-125-M42	25	45	125	42	57	49.4	53	45	96
HSK63A-SFFB25-155-M42	25	45	155	42	87	49.4	53	45	126



Shrink Chuck, 3°, Regular, Coolant
热缩刀柄 3 度, 端面出水型

 A ↗
 ≤0.003

 RPM
 G2.5/25000

AD

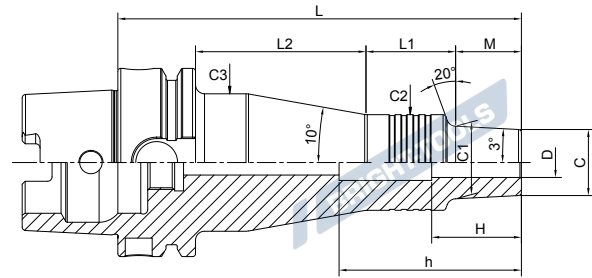

Size	D	C	L	M	L1	C1	C2	H	h
HSK63A-SFFB03-135-M22	03	9.5	135	22	33	11.8	26	9	110
HSK63A-SFFB03-155-M42	03	9.5	155	42	33	13.9	25	9	130
HSK63A-SFFB03-180-M67	03	9.5	180	67	33	16.5	26	9	155
HSK63A-SFFB04-135-M22	04	12	135	22	33	14.3	25	12	110
HSK63A-SFFB04-155-M42	04	12	155	42	33	16.4	25	12	130
HSK63A-SFFB04-180-M67	04	12	180	67	33	19	25	12	155
HSK63A-SFFB06-135-M22	06	14	135	22	30	16.3	32	18	109
HSK63A-SFFB06-155-M42	06	14	155	42	30	18.4	32	18	129
HSK63A-SFFB06-180-M67	06	14	180	67	30	21	32	18	154
HSK63A-SFFB08-135-M22	08	18	135	22	30	20.3	32	24	109
HSK63A-SFFB08-155-M42	08	18	155	42	30	22.4	32	24	129
HSK63A-SFFB08-180-M67	08	18	180	67	30	25	32	24	154
HSK63A-SFFB10-135-M22	10	22	135	22	30	24.3	42	30	109
HSK63A-SFFB10-155-M42	10	22	155	42	30	26.4	32	30	129
HSK63A-SFFB10-180-M67	10	22	180	67	28	29	42	30	154
HSK63A-SFFB12-135-M22	12	26	135	22	28	28.3	42	30	107
HSK63A-SFFB12-180-M67	12	26	180	67	28	33	42	30	152
HSK63A-SFFB16-180-M67	16	32	180	67	28	39	42	32	152

Shrink Chuck, 3°, Regular, Coolant

热缩刀柄 3 度, 端面出水型



A ↗ ≤0.003	RPM G2.5/25000	AD
---------------	-------------------	----

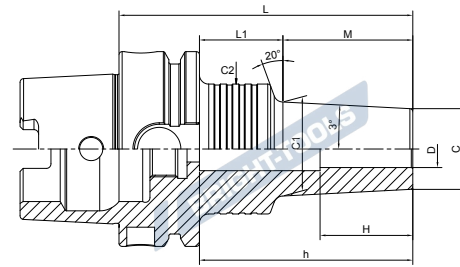

Size	D	C	L	M	L1	C1	C2	H	h
HSK100A-SFFB03-90-M22	03	9.5	90	22	39	11.8	26	9	60
HSK100A-SFFB03-110-M42	03	9.5	110	42	39	13.9	26	9	80
HSK100A-SFFB03-120-M22	03	9.5	120	22	69	11.8	26	9	90
HSK100A-SFFB03-135-M67	03	9.5	135	67	39	16.5	26	9	105
HSK100A-SFFB03-140-M42	03	9.5	140	42	69	13.9	25	9	111
HSK100A-SFFB03-165-M67	03	9.5	165	67	69	16.5	26	9	135
HSK100A-SFFB04-90-M22	04	12	90	22	39	14.3	26	12	61
HSK100A-SFFB04-110-M42	04	12	110	42	39	16.4	26	12	81
HSK100A-SFFB04-120-M22	04	12	120	22	69	14.3	25	12	91
HSK100A-SFFB04-135-M67	04	12	135	67	39	19	26	12	105
HSK100A-SFFB04-140-M42	04	12	140	42	69	16.4	26	12	111
HSK100A-SFFB04-165-M67	04	12	165	67	69	19	26	12	135
HSK100A-SFFB06-90-M22	06	14	90	22	39	16.3	32	18	61
HSK100A-SFFB06-110-M42	06	14	110	42	39	18.4	32	18	81
HSK100A-SFFB06-120-M22	06	14	120	22	69	16.3	32	18	91
HSK100A-SFFB06-135-M67	06	14	135	67	39	21	36	18	105
HSK100A-SFFB06-140-M42	06	14	140	42	69	18.4	32	18	111
HSK100A-SFFB06-165-M67	06	14	165	67	69	21	32	18	136
HSK100A-SFFB08-90-M22	08	18	90	22	39	20.3	36	24	60
HSK100A-SFFB08-110-M42	08	18	110	42	39	22.4	36	24	80
HSK100A-SFFB08-120-M22	08	18	120	22	69	20.3	32	24	91
HSK100A-SFFB08-135-M67	08	18	135	67	39	25	36	24	105
HSK100A-SFFB08-140-M42	08	18	140	42	69	22.4	36	24	110
HSK100A-SFFB08-165-M67	08	18	165	67	69	25	36	24	136
HSK100A-SFFB10-90-M22	10	22	90	22	39	24.3	32	30	61
HSK100A-SFFB10-110-M42	10	22	110	42	39	26.4	32	30	81
HSK100A-SFFB10-120-M22	10	22	120	22	69	24.3	32	30	91
HSK100A-SFFB10-135-M67	10	22	135	67	39	29	36	30	105
HSK100A-SFFB10-140-M42	10	22	140	42	69	26.4	36	30	110
HSK100A-SFFB10-165-M67	10	22	165	67	69	29	36	30	135

Shrink Chuck, 3°, Regular, Coolant
热缩刀柄 3 度, 端面出水型

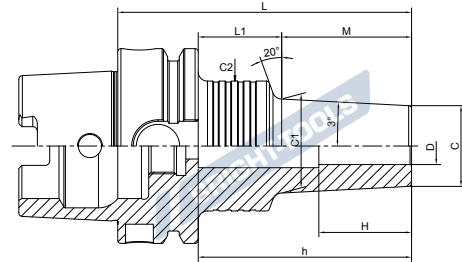

A ↗ ≤0.003	RPM G2.5/25000	AD
---------------	-------------------	----



Size	D	C	L	M	L1	C1	C2	H	h
HSK100A-SFFB12-90-M22	12	26	90	22	39	28.3	42	30	58
HSK100A-SFFB12-110-M42	12	26	110	42	39	30.4	42	30	78
HSK100A-SFFB12-120-M22	12	26	120	22	69	28.3	42	30	87
HSK100A-SFFB12-135-M67	12	26	135	67	39	33	50	30	100
HSK100A-SFFB12-140-M42	12	26	140	42	69	30.4	50	30	105
HSK100A-SFFB12-165-M67	12	26	165	67	69	33	42	30	132
HSK100A-SFFB12-170-M42	12	26	170	42	99	30.4	50	30	135
HSK100A-SFFB12-195-M67	12	26	195	67	28	33	42	30	162
HSK100A-SFFB16-90-M22	16	32	90	22	39	34.3	42	32	58
HSK100A-SFFB16-110-M42	16	32	110	42	39	36.4	42	32	75
HSK100A-SFFB16-120-M22	16	32	120	22	69	34.3	42	32	87
HSK100A-SFFB16-135-M67	16	32	135	67	39	39	42	32	103
HSK100A-SFFB16-140-M42	16	32	140	42	69	36.4	42	32	107
HSK100A-SFFB16-165-M67	16	32	165	67	69	39	42	32	132
HSK100A-SFFB16-170-M42	16	32	170	42	99	36.4	50	32	135
HSK100A-SFFB16-195-M67	16	32	195	67	28	39	50	32	162
HSK100A-SFFB20-110-M42	20	38	110	42	39	42.4	53	40	78
HSK100A-SFFB20-135-M67	20	38	135	67	39	45	53	40	103
HSK100A-SFFB20-140-M42	20	38	140	42	69	42.4	53	40	105
HSK100A-SFFB20-165-M67	20	38	165	67	69	45	53	40	130
HSK100A-SFFB20-170-M42	20	38	170	42	28	42.4	53	40	135
HSK100A-SFFB20-195-M67	20	38	195	67	99	45	50	40	160
HSK100A-SFFB25-110-M42	25	45	110	42	39	49.6	53	45	78
HSK100A-SFFB25-140-M42	25	45	140	42	69	49.6	50	45	105

Shrink Chuck, 3°, Regular, Coolant
热缩刀柄 3 度, 端面出水型

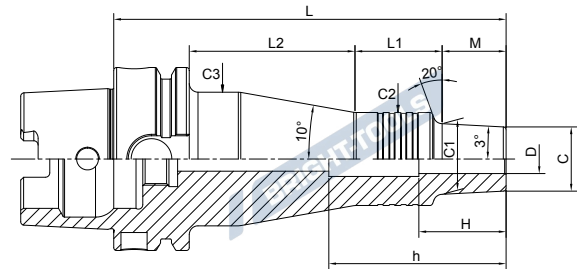
A ↗ ≤0.003	RPM G2.5/25000	AD
---------------	-------------------	----



Size	D	C	L	M	L1	L2	C1	C2	C3	H	h
HSK100A-SFFB03-150-M22	03	9.5	150	22	33	66	11.8	26	40	9	120
HSK100A-SFFB03-170-M42	03	9.5	170	42	33	66	13.9	26	40	9	140
HSK100A-SFFB03-195-M67	03	9.5	195	67	33	66	16.5	26	40	9	165
HSK100A-SFFB04-150-M22	04	12	150	22	33	66	14.3	25	39	12	121
HSK100A-SFFB04-170-M42	04	12	170	42	33	66	16.4	25	39	12	141
HSK100A-SFFB04-195-M67	04	12	195	67	33	66	19	25	39	12	166
HSK100A-SFFB06-150-M22	06	14	150	22	30	69	16.3	32	46	18	121
HSK100A-SFFB06-170-M42	06	14	170	42	30	69	18.4	36	46	18	141
HSK100A-SFFB06-195-M67	06	14	195	67	30	69	21	32	46	18	166
HSK100A-SFFB08-150-M22	08	18	150	22	30	69	20.3	32	46	24	121
HSK100A-SFFB08-170-M42	08	18	170	42	28	71	22.4	36	50	24	140
HSK100A-SFFB08-195-M67	08	18	195	67	30	69	25	32	46	24	166
HSK100A-SFFB10-150-M22	10	22	150	22	30	69	24.3	32	46	30	121
HSK100A-SFFB10-170-M42	10	22	170	42	30	69	26.4	32	46	30	141
HSK100A-SFFB10-195-M67	10	22	195	67	28	71	29	42	56	30	166
HSK100A-SFFB12-150-M22	12	26	150	22	28	71	28.3	42	56	30	117
HSK100A-SFFB16-150-M22	16	32	150	22	28	71	34.3	42	56	32	117
HSK100A-SFFB25-170-M42	25	45	170	42	28	71	49.6	53	67	45	135



Shrink Chuck, 3°, Regular, Coolant
 热缩刀柄 3 度, 端面出水型

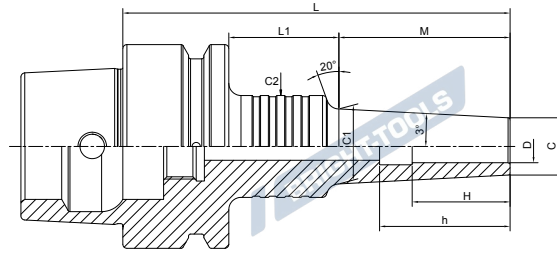
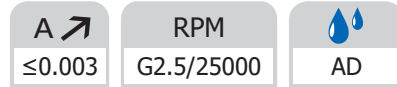

Size	D	C	L	M	L1	C1	C2	H	h
HSK50E-SFFB03-75-M22	03	9.5	75	22	27	11.8	25	9	61
HSK50E-SFFB04-75-M22	04	12	75	22	27	14.3	25	12	61
HSK50E-SFFB06-75-M22	06	14	75	22	27	16.3	32	18	60
HSK50E-SFFB08-75-M22	08	18	75	22	27	20.3	32	24	60
HSK50E-SFFB10-75-M22	10	22	75	22	27	24.3	32	30	60
HSK50E-SFFB12-75-M22	12	26	75	22	27	28.3	42	30	62
HSK50E-SFFB16-75-M22	16	32	75	22	27	34.3	42	32	62

Shrink Chuck, 3°, Regular, Coolant
热缩刀柄 3 度, 端面出水型

A ↗ ≤0.003	RPM G2.5/25000	AD
----------------------	--------------------------	-----------

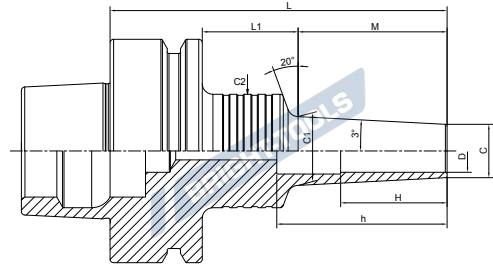

Size	D	C	L	M	L1	C1	C2	H	h
HSK63F-SFFB03-75-M22	03	9.5	75	22	27	11.8	25	9	58
HSK63F-SFFB03-95-M42	03	9.5	95	42	27	13.9	25	9	78
HSK63F-SFFB03-120-M67	03	9.5	120	67	27	16.5	25	9	103
HSK63F-SFFB04-75-M22	04	12	75	22	27	14.3	25	12	53
HSK63F-SFFB04-95-M42	04	12	95	42	27	16.4	25	12	78
HSK63F-SFFB04-120-M67	04	12	120	67	27	19	25	12	98
HSK63F-SFFB06-75-M22	06	14	75	22	27	16.3	32	18	58
HSK63F-SFFB08-75-M22	08	18	75	22	27	20.3	32	24	58
HSK63F-SFFB10-75-M22	10	22	75	22	27	24.3	32	30	54
HSK63F-SFFB12-75-M22	12	26	75	22	27	28.3	42	30	54
HSK63F-SFFB12-75-M22	12	26	75	22	27	28.3	42	30	54
HSK63F-SFFB20-75-M22	20	38	75	22	27	40.3	50	40	53
HSK63F-SFFB25-75-M22	25	45	75	22	27	47.3	50	45	53



Shrink Chuck, Curved

热缩刀柄，曲线型

A ↗ ≤0.003	RPM G2.5/25000	AD
---------------	-------------------	----

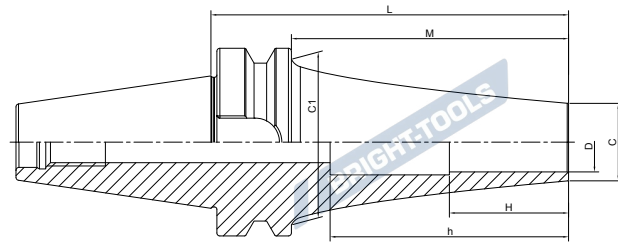

Size	D	C	L	M	C1	H	h
BT30-SFSA04-75 CV	04	7	75	53	34	12	99
BT30-SFSA04-90 CV	04	7	90	68	34	12	114
BT30-SFSA04-120 CV	04	7	120	98	34	12	144
BT30-SFRA04-90 CV	04	10	90	68	34	12	114
BT30-SFRA04-120 CV	04	10	120	98	34	12	144
BT30-SFSA06-75 CV	06	9	75	53	34	18	99
BT30-SFSA06-90 CV	06	9	90	68	34	18	114
BT30-SFSA06-120 CV	06	9	120	98	34	18	144
BT30-SFRA06-90 CV	06	13	90	68	34	18	114
BT30-SFRA06-120 CV	06	13	120	98	34	18	144
BT30-SFSA08-75 CV	08	11	75	53	34	24	99
BT30-SFSA08-90 CV	08	11	90	68	34	24	114
BT30-SFRA08-90 CV	08	16	90	68	34	24	114
BT30-SFSA10-75 CV	10	13	75	53	34	30	99
BT30-SFSA10-90 CV	10	13	90	68	34	30	114
BT30-SFRA10-90 CV	10	19	90	68	34	30	114

Shrink Chuck, Curved
热缩刀柄，曲线型

A ↗ ≤0.003	RPM G2.5/25000	AD
---------------	-------------------	----

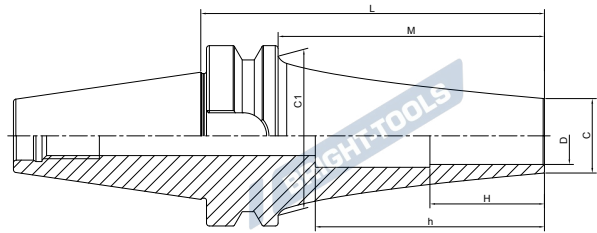

Size	D	C	L	M	C1	H	h
BT40-SFSA04-90 CV	04	7	90	63	53	12	125
BT40-SFSA04-120 CV	04	7	120	93	53	12	155
BT40-SFSA04-150 CV	04	7	150	123	53	12	185
BT40-SFSA04-180 CV	04	7	180	153	53	12	215
BT40-SFSA04-210 CV	04	7	210	183	53	12	245
BT40-SFSA04-240 CV	04	7	240	213	53	12	275
BT40-SFRA04-120 CV	04	10	120	93	53	12	155
BT40-SFRA04-150 CV	04	10	150	123	53	12	185
BT40-SFRA04-180 CV	04	10	180	153	53	12	215
BT40-SFRA04-210 CV	04	10	210	183	53	12	245
BT40-SFSA06-90 CV	06	9	90	63	53	18	125
BT40-SFSA06-120 CV	06	9	120	93	53	18	155
BT40-SFSA06-150 CV	06	9	150	123	53	18	185
BT40-SFSA06-180 CV	06	9	180	153	53	18	215
BT40-SFSA06-210 CV	06	9	210	183	53	18	245
BT40-SFSA06-240 CV	06	9	240	213	53	18	275
BT40-SFRA06-90 CV	06	13	90	63	53	18	125
BT40-SFRA06-120 CV	06	13	120	93	53	18	155
BT40-SFRA06-150 CV	06	13	150	123	53	18	185
BT40-SFRA06-180 CV	06	13	180	153	53	18	215
BT40-SFRA06-210 CV	06	13	210	183	53	18	245
BT40-SFFA06-90 CV	06	13	90	63	53	18	125
BT40-SFFA06-120 CV	06	13	120	93	53	18	155
BT40-SFFA06-150 CV	06	13	150	123	53	18	185
BT40-SFFA06-180 CV	06	13	180	153	53	18	215
BT40-SFFA06-210 CV	06	13	210	183	53	18	245



Shrink Chuck, Curved

热缩刀柄，曲线型

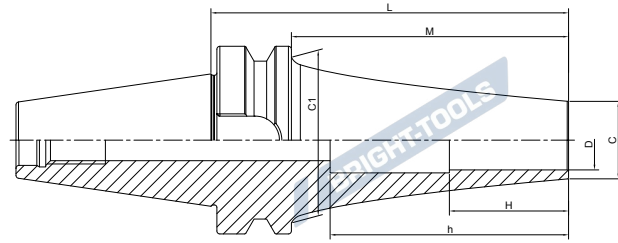
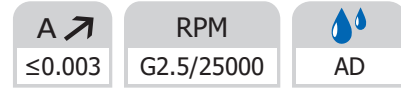

Size	D	C	L	M	C1	H	h
BT40-SFSA08-90 CV	08	11	90	63	53	24	125
BT40-SFSA08-120 CV	08	11	120	93	53	24	155
BT40-SFSA08-150 CV	08	11	150	123	53	24	185
BT40-SFSA08-180 CV	08	11	180	153	53	24	215
BT40-SFSA08-210 CV	08	11	210	183	53	24	245
BT40-SFSA08-240 CV	08	11	240	213	53	24	275
BT40-SFRA08-90 CV	08	16	90	63	53	24	125
BT40-SFRA08-120 CV	08	16	120	93	53	24	155
BT40-SFRA08-150 CV	08	16	150	123	53	24	185
BT40-SFRA08-180 CV	08	16	180	153	53	24	215
BT40-SFRA08-210 CV	08	16	210	183	53	24	245
BT40-SFFA08-90 CV	08	16	90	63	53	24	125
BT40-SFFA08-120 CV	08	16	120	93	53	24	155
BT40-SFFA08-150 CV	08	16	150	123	53	24	185
BT40-SFFA08-180 CV	08	16	180	153	53	24	215
BT40-SFFA08-210 CV	08	16	210	183	53	24	245
BT40-SFSA10-90 CV	10	13	90	63	53	30	125
BT40-SFSA10-120 CV	10	13	120	93	53	30	155
BT40-SFSA10-150 CV	10	13	150	123	53	30	185
BT40-SFSA10-180 CV	10	13	180	153	53	30	215
BT40-SFSA10-210 CV	10	13	210	183	53	30	245
BT40-SFSA10-240 CV	10	13	240	213	53	30	275
BT40-SFRA10-90 CV	10	19	90	63	53	30	125
BT40-SFRA10-120 CV	10	19	120	93	53	30	155
BT40-SFRA10-150 CV	10	19	150	123	53	30	185
BT40-SFRA10-180 CV	10	19	180	153	53	30	215
BT40-SFRA10-210 CV	10	19	210	183	53	30	245
BT40-SFFA10-90 CV	10	19	90	63	53	30	125
BT40-SFFA10-120 CV	10	19	120	93	53	30	155
BT40-SFFA10-150 CV	10	19	150	123	53	30	185
BT40-SFFA10-180 CV	10	19	180	153	53	30	215
BT40-SFFA10-210 CV	10	19	210	183	53	30	245

Shrink Chuck, Curved

热缩刀柄，曲线型

A ↗ ≤0.003	RPM G2.5/25000	AD
---------------	-------------------	----

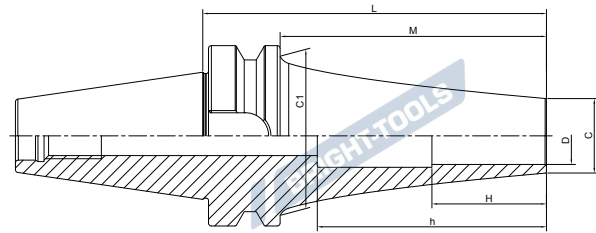

Size	D	C	L	M	C1	H	h
BT40-SFSA12-90 CV	12	15	90	63	53	30	125
BT40-SFSA12-120 CV	12	15	120	93	53	30	155
BT40-SFSA12-150 CV	12	15	150	123	53	30	185
BT40-SFSA12-180 CV	12	15	180	153	53	30	215
BT40-SFSA12-210 CV	12	15	210	183	53	30	245
BT40-SFSA12-240 CV	12	15	240	213	53	30	275
BT40-SFRA12-90 CV	12	22	90	63	53	30	125
BT40-SFRA12-120 CV	12	22	120	93	53	30	155
BT40-SFRA12-150 CV	12	22	150	123	53	30	185
BT40-SFRA12-180 CV	12	22	180	153	53	30	215
BT40-SFRA12-210 CV	12	22	210	183	53	30	245
BT40-SFFA12-90 CV	12	22	90	63	53	30	125
BT40-SFFA12-120 CV	12	22	120	93	53	30	155
BT40-SFFA12-150 CV	12	22	150	123	53	30	185
BT40-SFFA12-180 CV	12	22	180	153	53	30	215
BT40-SFFA12-210 CV	12	22	210	183	53	30	245
BT40-SFSB16-90 CV	16	21	90	63	53	32	100
BT40-SFSB16-120 CV	16	21	120	93	53	32	130
BT40-SFSB16-150 CV	16	21	150	123	53	32	160
BT40-SFSB16-180 CV	16	21	180	153	53	32	190
BT40-SFSB16-210 CV	16	21	210	183	53	32	220
BT40-SFSB16-240 CV	16	21	240	213	53	32	250
BT40-SFSB20-90 CV	20	26	90	63	50.5	40	100
BT40-SFSB20-120 CV	20	26	120	93	53	40	130
BT40-SFSB20-150 CV	20	26	150	123	53	40	160
BT40-SFSB20-180 CV	20	26	180	153	53	40	190
BT40-SFSB20-210 CV	20	26	210	183	53	40	220
BT40-SFSB20-240 CV	20	26	240	213	53	40	250



Shrink Chuck, Curved

热缩刀柄，曲线型

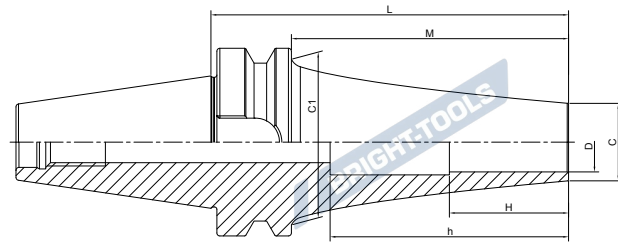
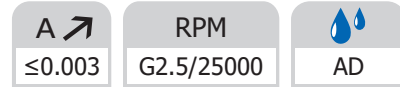

Size	D	C	L	M	C1	H	h
BT50-SFSA04-165 CV	04	7	165	127	85	12	220
BT50-SFSA04-195 CV	04	7	195	157	85	12	250
BT50-SFSA04-225 CV	04	7	225	187	85	12	280
BT50-SFSA04-255 CV	04	7	255	217	85	12	310
BT50-SFSA04-285 CV	04	7	285	247	85	12	340
BT50-SFSA04-315 CV	04	7	315	277	85	12	370
BT50-SFSA06-165 CV	06	9	165	127	85	18	220
BT50-SFSA06-195 CV	06	9	195	157	85	18	250
BT50-SFSA06-225 CV	06	9	225	187	85	18	280
BT50-SFSA06-255 CV	06	9	255	217	85	18	310
BT50-SFSA06-285 CV	06	9	285	247	85	18	340
BT50-SFSA06-315 CV	06	9	315	277	85	18	370
BT50-SFSA08-165 CV	08	11	165	127	85	24	220
BT50-SFSA08-195 CV	08	11	195	157	85	24	250
BT50-SFSA08-225 CV	08	11	225	187	85	24	280
BT50-SFSA08-255 CV	08	11	255	217	85	24	310
BT50-SFSA08-285 CV	08	11	285	247	85	24	340
BT50-SFSA08-315 CV	08	11	315	277	85	24	370
BT50-SFRA08-195 CV	08	16	195	157	85	24	250
BT50-SFRA08-225 CV	08	16	225	187	85	24	280
BT50-SFRA08-255 CV	08	16	255	217	85	24	310
BT50-SFRA08-285 CV	08	16	285	247	85	24	340
BT50-SFFA08-195 CV	08	16	195	157	85	24	250
BT50-SFFA08-225 CV	08	16	225	187	85	24	280
BT50-SFFA08-255 CV	08	16	255	217	85	24	310
BT50-SFFA08-285 CV	08	16	285	247	85	24	340

Shrink Chuck, Curved
热缩刀柄，曲线型

A ↗ ≤0.003	RPM G2.5/25000	AD
---------------	-------------------	----

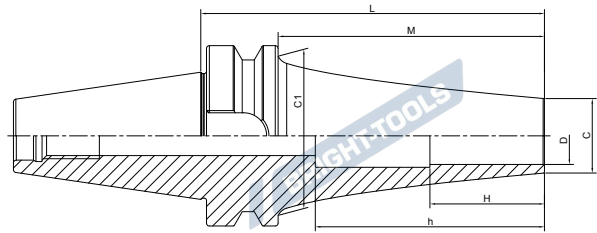

Size	D	C	L	M	C1	H	h
BT50-SFSA10-165 CV	10	13	165	127	85	30	220
BT50-SFSA10-195 CV	10	13	195	157	85	30	250
BT50-SFSA10-225 CV	10	13	225	187	85	30	280
BT50-SFSA10-255 CV	10	13	255	217	85	30	310
BT50-SFSA10-285 CV	10	13	285	247	85	30	340
BT50-SFSA10-315 CV	10	13	315	277	85	30	370
BT50-SFRA10-165 CV	10	19	165	127	85	30	220
BT50-SFRA10-195 CV	10	19	195	157	85	30	250
BT50-SFRA10-225 CV	10	19	225	187	85	30	280
BT50-SFRA10-255 CV	10	19	255	217	85	30	310
BT50-SFRA10-285 CV	10	19	285	247	85	30	340
BT50-SFFA10-165 CV	10	19	165	127	85	30	220
BT50-SFFA10-195 CV	10	19	195	157	85	30	250
BT50-SFFA10-225 CV	10	19	225	187	85	30	280
BT50-SFFA10-255 CV	10	19	255	217	85	30	310
BT50-SFFA10-285 CV	10	19	285	247	85	30	340
BT50-SFSA12-165 CV	12	15	165	127	84	30	220
BT50-SFSA12-195 CV	12	15	195	157	85	30	250
BT50-SFSA12-225 CV	12	15	225	187	85	30	280
BT50-SFSA12-255 CV	12	15	255	217	85	30	310
BT50-SFSA12-285 CV	12	15	285	247	85	30	340
BT50-SFSA12-315 CV	12	15	315	277	85	30	370
BT50-SFRA12-165 CV	12	22	165	127	85	30	220
BT50-SFRA12-195 CV	12	22	195	157	85	30	250
BT50-SFRA12-225 CV	12	22	225	187	85	30	280
BT50-SFRA12-255 CV	12	22	255	217	85	30	310
BT50-SFRA12-285 CV	12	22	285	247	85	30	340
BT50-SFFA12-165 CV	12	22	165	127	85	30	220
BT50-SFFA12-195 CV	12	22	195	157	85	30	250
BT50-SFFA12-225 CV	12	22	225	187	85	30	280
BT50-SFFA12-255 CV	12	22	255	217	85	30	310
BT50-SFFA12-285 CV	12	22	285	247	85	30	340

Shrink Chuck, Curved

热缩刀柄，曲线型

A ↗ ≤0.003	RPM G2.5/25000	AD
---------------	-------------------	----

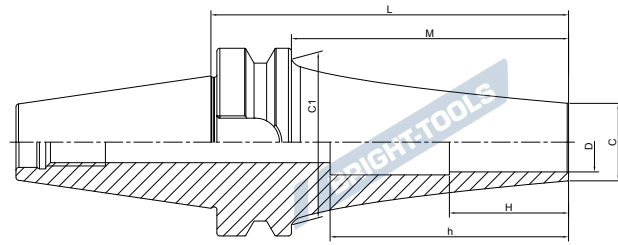

Size	D	C	L	M	C1	H	h
BT50-SFSB16-165 CV	16	21	165	127	85	32	220
BT50-SFSB16-195 CV	16	21	195	157	85	32	250
BT50-SFSB16-225 CV	16	21	225	187	85	32	280
BT50-SFSB16-255 CV	16	21	255	217	85	32	310
BT50-SFSB16-285 CV	16	21	285	247	85	32	340
BT50-SFSB16-315 CV	16	21	315	277	85	32	370
BT50-SFSB20-165 CV	20	26	165	127	85	40	220
BT50-SFSB20-195 CV	20	26	195	157	85	40	250
BT50-SFSB20-225 CV	20	26	225	187	85	40	280
BT50-SFSB20-255 CV	20	26	255	217	85	40	310
BT50-SFSB20-285 CV	20	26	285	247	85	40	340
BT50-SFSB20-315 CV	20	26	315	277	85	40	370

Shrink Chuck, Curved

热缩刀柄，曲线型

A ↗ ≤0.003	RPM G2.5/25000	AD
---------------	-------------------	----

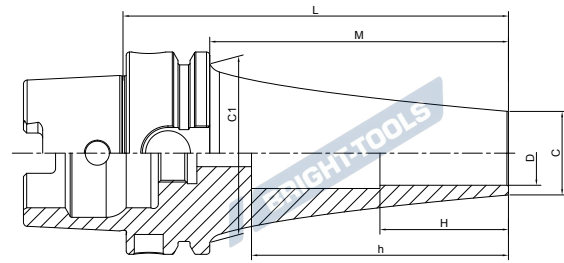

Size	D	C	L	M	C1	H	h
HSK63A-SFSA04-90 CV	04	7	90	64	53	12	65
HSK63A-SFSA04-120 CV	04	7	120	94	53	12	95
HSK63A-SFSA04-150 CV	04	7	150	124	53	12	125
HSK63A-SFSA04-180 CV	04	7	180	154	53	12	154
HSK63A-SFSA04-210 CV	04	7	210	184	53	12	185
HSK63A-SFSA04-240 CV	04	7	240	214	53	12	214
HSK63A-SFSA04-270 CV	04	7	270	244	53	12	245
HSK63A-SFSA04-300 CV	04	7	300	274	53	12	275
HSK63A-SFRA04-120 CV	04	10	120	94	53	12	95
HSK63A-SFRA04-150 CV	04	10	150	124	53	12	125
HSK63A-SFRA04-180 CV	04	10	180	154	53	12	155
HSK63A-SFRA04-210 CV	04	10	210	184	53	12	185
HSK63A-SFSA06-90 CV	06	9	90	64	53	18	65
HSK63A-SFSA06-120 CV	06	9	120	94	53	18	95
HSK63A-SFSA06-150 CV	06	9	150	124	53	18	125
HSK63A-SFSA06-180 CV	06	9	180	154	53	18	154
HSK63A-SFSA06-210 CV	06	9	210	184	53	18	184
HSK63A-SFSA06-240 CV	06	9	240	214	53	18	214
HSK63A-SFSA06-270 CV	06	9	270	244	53	18	245
HSK63A-SFSA06-300 CV	06	9	300	274	53	18	275
HSK63A-SFRA06-90 CV	06	13	90	64	53	18	65
HSK63A-SFRA06-120 CV	06	13	120	94	53	18	95
HSK63A-SFRA06-150 CV	06	13	150	124	53	18	125
HSK63A-SFRA06-180 CV	06	13	180	154	53	18	155
HSK63A-SFRA06-210 CV	06	13	210	184	53	18	185
HSK63A-SFFA06-90 CV	06	13	90	64	53	18	65
HSK63A-SFFA06-120 CV	06	13	120	94	53	18	95
HSK63A-SFFA06-150 CV	06	13	150	124	53	18	125
HSK63A-SFFA06-180 CV	06	13	180	154	53	18	155
HSK63A-SFFA06-210 CV	06	13	210	184	53	18	185

Shrink Chuck, Curved
 热缩刀柄，曲线型

A ↗ ≤0.003	RPM G2.5/25000	 AD
---------------	-------------------	--------

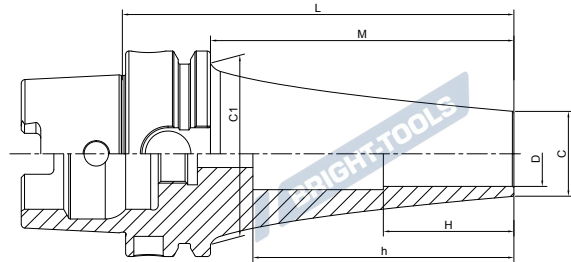

Size	D	C	L	M	C1	H	h
HSK63A-SFSA08-90 CV	08	11	90	64	53	24	65
HSK63A-SFSA08-120 CV	08	11	120	94	53	24	94
HSK63A-SFSA08-150 CV	08	11	150	124	53	24	124
HSK63A-SFSA08-180 CV	08	11	180	154	53	24	155
HSK63A-SFSA08-210 CV	08	11	210	184	53	24	184
HSK63A-SFSA08-240 CV	08	11	240	214	53	24	214
HSK63A-SFSA08-270 CV	08	11	270	244	53	24	244
HSK63A-SFSA08-300 CV	08	11	300	274	53	24	274
HSK63A-SFRA08-90 CV	08	16	90	64	53	24	65
HSK63A-SFRA08-120 CV	08	16	120	94	53	24	95
HSK63A-SFRA08-150 CV	08	16	150	124	53	24	125
HSK63A-SFRA08-180 CV	08	16	180	154	53	24	155
HSK63A-SFRA08-210 CV	08	16	210	184	53	24	185
HSK63A-SFFA08-90 CV	08	16	90	64	53	24	65
HSK63A-SFFA08-120 CV	08	16	120	94	53	24	95
HSK63A-SFFA08-150 CV	08	16	150	124	53	24	125
HSK63A-SFFA08-180 CV	08	16	180	154	53	24	155
HSK63A-SFFA08-210 CV	08	16	210	184	53	24	185

Shrink Chuck, Curved
热缩刀柄，曲线型

A ↗ ≤0.003	RPM G2.5/25000	AD
---------------	-------------------	----

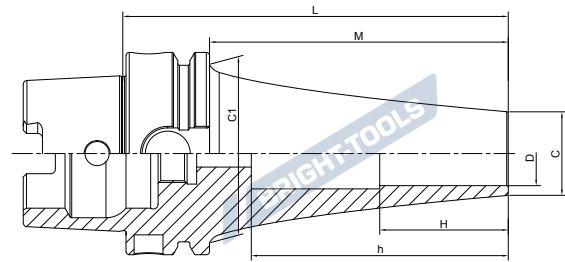

Size	D	C	L	M	C1	H	h
HSK63A-SFSA10-90 CV	10	13	90	64	53	30	65
HSK63A-SFSA10-120 CV	10	13	120	94	53	30	95
HSK63A-SFSA10-150 CV	10	13	150	124	53	30	125
HSK63A-SFSA10-180 CV	10	13	180	154	53	30	154
HSK63A-SFSA10-210 CV	10	13	210	184	53	30	184
HSK63A-SFSA10-240 CV	10	13	240	214	53	30	212
HSK63A-SFSA10-270 CV	10	13	270	244	53	30	244
HSK63A-SFSA10-300 CV	10	13	300	274	53	30	274
HSK63A-SFRA10-90 CV	10	19	90	64	53	30	65
HSK63A-SFRA10-120 CV	10	19	120	94	53	30	95
HSK63A-SFRA10-150 CV	10	19	150	124	53	30	125
HSK63A-SFRA10-180 CV	10	19	180	154	53	30	155
HSK63A-SFRA10-210 CV	10	19	210	184	53	30	185
HSK63A-SFFA10-90 CV	10	19	90	64	53	30	65
HSK63A-SFFA10-120 CV	10	19	120	94	53	30	95
HSK63A-SFFA10-150 CV	10	19	150	124	53	30	125
HSK63A-SFFA10-180 CV	10	19	180	154	53	30	155
HSK63A-SFFA10-210 CV	10	19	210	184	53	30	185

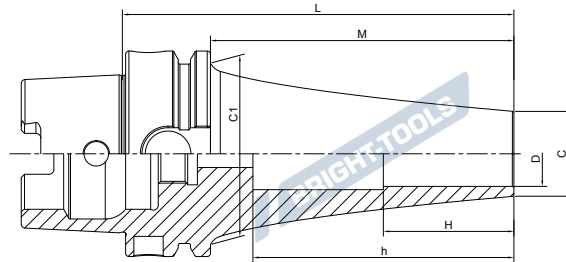
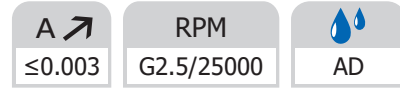

Shrink Chuck, Curved
热缩刀柄，曲线型

Size	D	C	L	M	C1	H	h
HSK63A-SFSA12-90 CV	12	15	90	64	53	30	64
HSK63A-SFSA12-120 CV	12	15	120	94	53	30	94
HSK63A-SFSA12-150 CV	12	15	150	124	53	30	124
HSK63A-SFSA12-180 CV	12	15	180	154	53	30	154
HSK63A-SFSA12-210 CV	12	15	210	184	53	30	184
HSK63A-SFSA12-240 CV	12	15	240	214	53	30	212
HSK63A-SFSA12-270 CV	12	15	270	244	53	30	244
HSK63A-SFRA12-90 CV	12	22	90	64	53	30	64
HSK63A-SFRA12-120 CV	12	22	120	94	53	30	94
HSK63A-SFRA12-150 CV	12	22	150	124	53	30	124
HSK63A-SFRA12-180 CV	12	22	180	154	53	30	154
HSK63A-SFRA12-210 CV	12	22	210	184	53	30	184
HSK63A-SFFA12-90 CV	12	22	90	64	53	30	64
HSK63A-SFFA12-120 CV	12	22	120	94	53	30	94
HSK63A-SFFA12-150 CV	12	22	150	124	53	30	124
HSK63A-SFFA12-180 CV	12	22	180	154	53	30	154
HSK63A-SFFA12-210 CV	12	22	210	184	53	30	184
HSK63A-SFSB16-90 CV	16	21	90	64	53	32	62
HSK63A-SFSB16-120 CV	16	21	120	94	53	32	92
HSK63A-SFSB16-150 CV	16	21	150	124	53	32	122
HSK63A-SFSB16-180 CV	16	21	180	154	53	32	152
HSK63A-SFSB16-210 CV	16	21	210	184	53	32	182
HSK63A-SFSB16-240 CV	16	21	240	214	53	32	212
HSK63A-SFSB16-270 CV	16	21	270	244	53	32	242
HSK63A-SFSB20-90 CV	20	26	90	64	51	40	62
HSK63A-SFSB20-120 CV	20	26	120	94	53	40	92
HSK63A-SFSB20-150 CV	20	26	150	124	53	40	122
HSK63A-SFSB20-180 CV	20	26	180	154	53	40	152
HSK63A-SFSB20-210 CV	20	26	210	184	53	40	182
HSK63A-SFSB20-240 CV	20	26	240	214	53	40	212
HSK63A-SFSB20-270 CV	20	26	270	244	53	40	242

Shrink Chuck, Curved
热缩刀柄，曲线型



A ↗ ≤0.003	RPM G2.5/25000	AD
---------------	-------------------	----

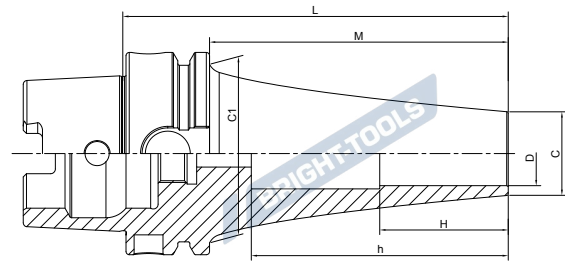

Size	D	C	L	M	C1	H	h
HSK100A-SFSA04-165 CV	04	7	165	136	85	12	133
HSK100A-SFSA04-195 CV	04	7	195	166	85	12	163
HSK100A-SFSA04-225 CV	04	7	225	196	85	12	196
HSK100A-SFSA04-255 CV	04	7	255	226	85	12	226
HSK100A-SFSA04-285 CV	04	7	285	256	85	12	256
HSK100A-SFSA04-315 CV	04	7	315	286	85	12	286
HSK100A-SFSA04-345 CV	04	7	345	316	85	12	316
HSK100A-SFSA06-165 CV	06	9	165	136	85	18	136
HSK100A-SFSA06-195 CV	06	9	195	166	85	18	166
HSK100A-SFSA06-225 CV	06	9	225	196	85	18	196
HSK100A-SFSA06-255 CV	06	9	255	226	85	18	226
HSK100A-SFSA06-285 CV	06	9	285	256	85	18	256
HSK100A-SFSA06-315 CV	06	9	315	286	85	18	286
HSK100A-SFSA06-345 CV	06	9	345	316	85	18	316
HSK100A-SFSA08-165 CV	08	11	165	136	85	24	136
HSK100A-SFSA08-195 CV	08	11	195	166	85	24	166
HSK100A-SFSA08-225 CV	08	11	225	196	85	24	196
HSK100A-SFSA08-255 CV	08	11	255	226	85	24	226
HSK100A-SFSA08-285 CV	08	11	285	256	85	24	256
HSK100A-SFSA08-315 CV	08	11	315	286	85	24	286
HSK100A-SFSA08-345 CV	08	11	345	316	85	24	311
HSK100A-SFRA08-195 CV	08	16	195	166	85	24	166
HSK100A-SFRA08-225 CV	08	16	225	196	85	24	196
HSK100A-SFRA08-255 CV	08	16	255	226	85	24	226
HSK100A-SFRA08-285 CV	08	16	285	256	85	24	256
HSK100A-SFFA08-195 CV	08	16	195	166	85	24	166
HSK100A-SFFA08-225 CV	08	16	225	196	85	24	196
HSK100A-SFFA08-255 CV	08	16	255	226	85	24	226
HSK100A-SFFA08-285 CV	08	16	285	256	85	24	256



Shrink Chuck, Curved

热缩刀柄，曲线型

A ↗ ≤0.003	RPM G2.5/25000	AD
---------------	-------------------	----

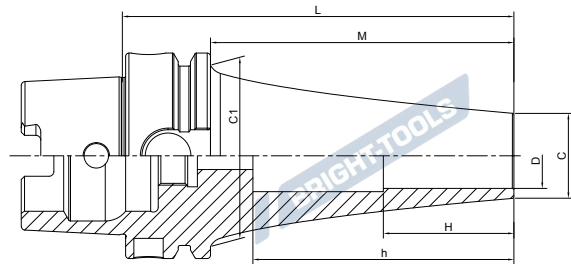

Size	D	C	L	M	C1	H	h
HSK100A-SFSA10-165 CV	10	13	165	136	85	30	136
HSK100A-SFSA10-195 CV	10	13	195	166	85	30	166
HSK100A-SFSA10-225 CV	10	13	225	196	85	30	196
HSK100A-SFSA10-255 CV	10	13	255	226	85	30	226
HSK100A-SFSA10-285 CV	10	13	285	256	85	30	256
HSK100A-SFSA10-315 CV	10	13	315	286	85	30	286
HSK100A-SFSA10-345 CV	10	13	345	316	85	30	316
HSK100A-SFRA10-165 CV	10	19	165	136	85	30	136
HSK100A-SFRA10-195 CV	10	19	195	166	85	30	166
HSK100A-SFRA10-225 CV	10	19	225	196	85	30	196
HSK100A-SFRA10-255 CV	10	19	255	226	85	30	226
HSK100A-SFRA10-285 CV	10	19	285	256	85	30	256
HSK100A-SFFA10-165 CV	10	19	165	136	85	30	136
HSK100A-SFFA10-195 CV	10	19	195	166	85	30	166
HSK100A-SFFA10-225 CV	10	19	225	196	85	30	196
HSK100A-SFFA10-255 CV	10	19	255	226	85	30	226
HSK100A-SFFA10-285 CV	10	19	285	256	85	30	256

BRIGHT-TOOLS

BRIGHT-TOOLS

BRIGHT-TOOLS

BRIGHT-TOOLS

Shrink Chuck, Curved
热缩刀柄，曲线型



A ↗ ≤0.003	RPM G2.5/25000	AD
---------------	-------------------	----

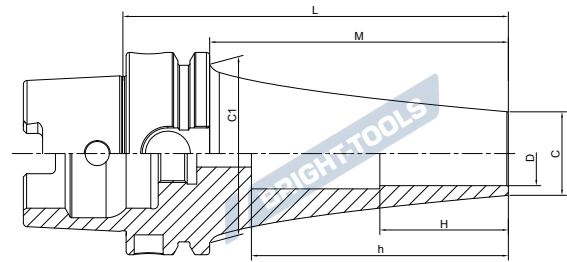

Size	D	C	L	M	C1	H	h
HSK100A-SFSA12-165 CV	12	15	165	136	85	30	133
HSK100A-SFSA12-195 CV	12	15	195	166	85	30	163
HSK100A-SFSA12-225 CV	12	15	225	196	85	30	175
HSK100A-SFSA12-255 CV	12	15	255	226	85	30	190
HSK100A-SFSA12-285 CV	12	15	285	256	85	30	251
HSK100A-SFSA12-315 CV	12	15	315	286	85	30	281
HSK100A-SFSA12-345 CV	12	15	345	316	85	30	311
HSK100A-SFRA12-165 CV	12	22	165	136	85	30	133
HSK100A-SFRA12-195 CV	12	22	195	166	85	30	163
HSK100A-SFRA12-225 CV	12	22	225	196	85	30	159
HSK100A-SFRA12-255 CV	12	22	255	226	85	30	221
HSK100A-SFRA12-285 CV	12	22	285	256	85	30	251
HSK100A-SFFA12-165 CV	12	22	165	136	85	30	133
HSK100A-SFFA12-195 CV	12	22	195	166	85	30	163
HSK100A-SFFA12-225 CV	12	22	225	196	85	30	159
HSK100A-SFFA12-255 CV	12	22	255	226	85	30	221
HSK100A-SFFA12-285 CV	12	22	285	256	85	30	251
HSK100A-SFSB16-165 CV	16	21	165	136	85	32	131
HSK100A-SFSB16-195 CV	16	21	195	166	85	32	161
HSK100A-SFSB16-225 CV	16	21	225	196	85	32	191
HSK100A-SFSB16-255 CV	16	21	255	226	85	32	221
HSK100A-SFSB16-285 CV	16	21	285	256	85	32	251
HSK100A-SFSB16-315 CV	16	21	315	286	85	32	281
HSK100A-SFSB16-345 CV	16	21	345	316	85	32	311
HSK100A-SFSB20-165 CV	20	26	165	136	85	40	132
HSK100A-SFSB20-195 CV	20	26	195	166	85	40	161
HSK100A-SFSB20-225 CV	20	26	225	196	85	40	191
HSK100A-SFSB20-255 CV	20	26	255	226	85	40	221
HSK100A-SFSB20-285 CV	20	26	285	256	85	40	251
HSK100A-SFSB20-315 CV	20	26	315	286	85	40	281
HSK100A-SFSB20-345 CV	20	26	345	316	85	40	311

Shrink Chuck, Curved

热缩刀柄，曲线型

 A ↗
 ≤0.003

 RPM
 G2.5/25000

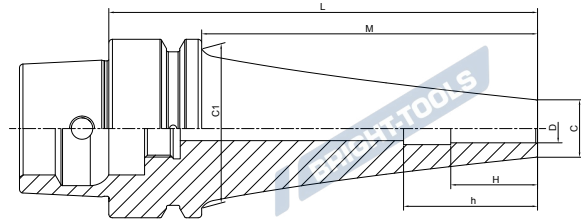
 AD

Size	D	C	L	M	C1	H	h
HSK32E-SFSA04-60 CV	04	7	60	40	12	12	43
HSK32E-SFSA04-90 CV	04	7	90	70	12	12	73
HSK32E-SFSA06-60 CV	06	9	60	40	18	18	43
HSK32E-SFSA06-90 CV	06	9	90	70	18	18	73
HSK32E-SFSA08-60 CV	08	11	60	40	24	24	38
HSK32E-SFSA08-90 CV	08	11	90	70	24	24	38
HSK32E-SFSA10-60 CV	10	13	60	40	30	30	48
HSK32E-SFSA10-90 CV	10	13	90	70	30	30	60

Shrink Chuck, Curved
热缩刀柄，曲线型

A ↗ ≤0.003	RPM G2.5/25000	AD
---------------	-------------------	----

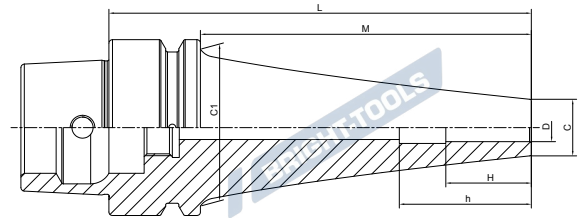

Size	D	C	L	M	C1	H	h
HSK40E-SFSA04-90 CV	04	7	90	70	34	12	74
HSK40E-SFSA04-120 CV	04	7	120	100	34	12	104
HSK40E-SFSA04-150 CV	04	7	150	130	34	12	134
HSK40E-SFRA04-90 CV	04	10	90	70	34	12	74
HSK40E-SFRA04-120 CV	04	10	120	100	34	12	104
HSK40E-SFSA06-90 CV	06	9	90	70	34	18	74
HSK40E-SFSA06-120 CV	06	9	120	100	34	18	104
HSK40E-SFSA06-150 CV	06	9	150	130	34	18	134
HSK40E-SFRA06-90 CV	06	13	90	70	34	18	74
HSK40E-SFRA06-120 CV	06	13	120	100	34	18	104
HSK40E-SFSA08-90 CV	08	11	90	70	34	24	74
HSK40E-SFSA08-120 CV	08	11	120	100	34	24	104
HSK40E-SFSA08-150 CV	08	11	150	130	34	24	134
HSK40E-SFRA08-90 CV	08	16	90	70	34	24	74
HSK40E-SFRA08-120 CV	08	16	120	100	34	24	104
HSK40E-SFSA10-90 CV	10	13	90	70	34	30	74
HSK40E-SFSA10-120 CV	10	13	120	100	34	30	104
HSK40E-SFSA10-150 CV	10	13	150	130	34	30	134
HSK40E-SFRA10-90 CV	10	19	90	70	34	30	74
HSK40E-SFRA10-120 CV	10	19	120	100	34	30	104



Shrink Chuck, Curved
 热缩刀柄，曲线型

A ↗ ≤0.003	RPM G2.5/25000	AD
---------------	-------------------	----

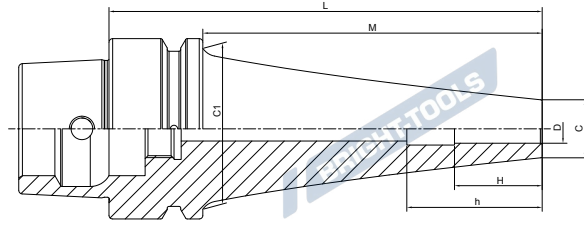

Size	D	C	L	M	C1	H	h
HSK50E-SFSA04-90 CV	04	7	90	64	42	12	74
HSK50E-SFSA04-120 CV	04	7	120	94	42	12	104
HSK50E-SFSA04-150 CV	04	7	150	124	42	12	134
HSK50E-SFSA04-180 CV	04	7	180	154	42	12	164
HSK50E-SFRA04-120 CV	04	10	120	94	42	12	104
HSK50E-SFRA04-150 CV	04	10	150	124	42	12	134
HSK50E-SFSA06-90 CV	06	9	90	64	42	18	74
HSK50E-SFSA06-120 CV	06	9	120	94	42	18	104
HSK50E-SFSA06-150 CV	06	9	150	124	42	18	134
HSK50E-SFSA06-180 CV	06	9	180	154	42	18	164
HSK50E-SFRA06-120 CV	06	13	120	94	42	18	104
HSK50E-SFRA06-150 CV	06	13	150	124	42	18	132
HSK50E-SFSA08-90 CV	08	11	90	64	42	24	74
HSK50E-SFSA08-120 CV	08	11	120	94	42	24	104
HSK50E-SFSA08-150 CV	08	11	150	124	42	24	134
HSK50E-SFSA08-180 CV	08	11	180	154	42	24	164
HSK50E-SFRA08-120 CV	08	16	120	94	42	24	102
HSK50E-SFRA08-150 CV	08	16	150	124	42	24	132
HSK50E-SFSA10-90 CV	10	13	90	64	42	30	74
HSK50E-SFSA10-120 CV	10	13	120	94	42	30	104
HSK50E-SFSA10-150 CV	10	13	150	124	42	30	134
HSK50E-SFSA10-180 CV	10	13	180	154	42	30	162
HSK50E-SFRA10-150 CV	10	19	150	124	42	30	132

Shrink Chuck, Curved

热缩刀柄，曲线型



A ↗ ≤0.003	RPM G2.5/25000	AD
----------------------	--------------------------	-----------

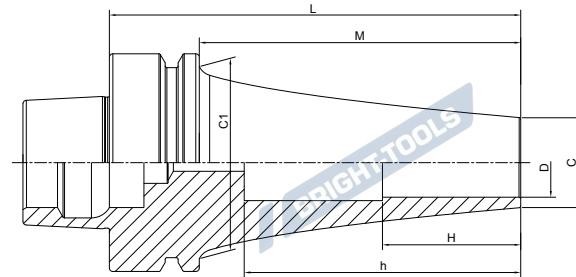

Size	D	C	L	M	C1	H	h
HSK63F-SFSA04-90 CV	04	7	90	64	53	12	65
HSK63F-SFSA04-120 CV	04	7	120	94	53	12	95
HSK63F-SFSA04-150 CV	04	7	150	124	53	12	125
HSK63F-SFSA04-180 CV	04	7	180	154	53	12	154
HSK63F-SFSA04-210 CV	04	7	210	184	53	12	185
HSK63F-SFSA04-240 CV	04	7	240	214	53	12	214
HSK63F-SFSA04-270 CV	04	7	270	244	53	12	245
HSK63F-SFSA04-300 CV	04	7	300	274	53	12	275
HSK63F-SFRA04-120 CV	04	10	120	94	53	12	95
HSK63F-SFRA04-150 CV	04	10	150	124	53	12	125
HSK63F-SFRA04-180 CV	04	10	180	154	53	12	155
HSK63F-SFRA04-210 CV	04	10	210	184	53	12	185
HSK63F-SFSA06-90 CV	06	9	90	64	53	18	65
HSK63F-SFSA06-120 CV	06	9	120	94	53	18	95
HSK63F-SFSA06-150 CV	06	9	150	124	53	18	125
HSK63F-SFSA06-180 CV	06	9	180	154	53	18	154
HSK63F-SFSA06-210 CV	06	9	210	184	53	18	184
HSK63F-SFSA06-240 CV	06	9	240	214	53	18	214
HSK63F-SFSA06-270 CV	06	9	270	244	53	18	245
HSK63F-SFSA06-300 CV	06	9	300	274	53	18	275
HSK63F-SFRA06-90 CV	06	13	90	64	53	18	65
HSK63F-SFRA06-120 CV	06	13	120	94	53	18	95
HSK63F-SFRA06-150 CV	06	13	150	124	53	18	125
HSK63F-SFRA06-180 CV	06	13	180	154	53	18	155
HSK63F-SFRA06-210 CV	06	13	210	184	53	18	185
HSK63F-SFFA06-90 CV	06	13	90	64	53	18	65
HSK63F-SFFA06-120 CV	06	13	120	94	53	18	95
HSK63F-SFFA06-150 CV	06	13	150	124	53	18	125
HSK63F-SFFA06-180 CV	06	13	180	154	53	18	155
HSK63F-SFFA06-210 CV	06	13	210	184	53	18	185



Shrink Chuck, Curved

热缩刀柄，曲线型

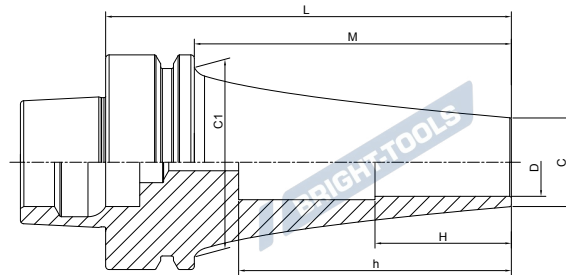
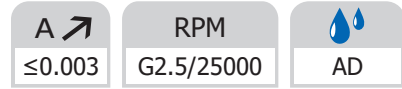

Size	D	C	L	M	C1	H	h
HSK63F-SFSA08-90 CV	08	11	90	64	53	24	65
HSK63F-SFSA08-120 CV	08	11	120	94	53	24	94
HSK63F-SFSA08-150 CV	08	11	150	124	53	24	124
HSK63F-SFSA08-180 CV	08	11	180	154	53	24	155
HSK63F-SFSA08-210 CV	08	11	210	184	53	24	184
HSK63F-SFSA08-240 CV	08	11	240	214	53	24	214
HSK63F-SFSA08-270 CV	08	11	270	244	53	24	244
HSK63F-SFSA08-300 CV	08	11	300	274	53	24	274
HSK63F-SFRA08-90 CV	08	16	90	64	53	24	65
HSK63F-SFRA08-120 CV	08	16	120	94	53	24	95
HSK63F-SFRA08-150 CV	08	16	150	124	53	24	125
HSK63F-SFRA08-180 CV	08	16	180	154	53	24	155
HSK63F-SFRA08-210 CV	08	16	210	184	53	24	185
HSK63F-SFFA08-90 CV	08	16	90	64	53	24	65
HSK63F-SFFA08-120 CV	08	16	120	94	53	24	95
HSK63F-SFFA08-150 CV	08	16	150	124	53	24	125
HSK63F-SFFA08-180 CV	08	16	180	154	53	24	155
HSK63F-SFFA08-210 CV	08	16	210	184	53	24	185

Shrink Chuck, Curved
热缩刀柄，曲线型

A ↗ ≤0.003	RPM G2.5/25000	AD
---------------	-------------------	----

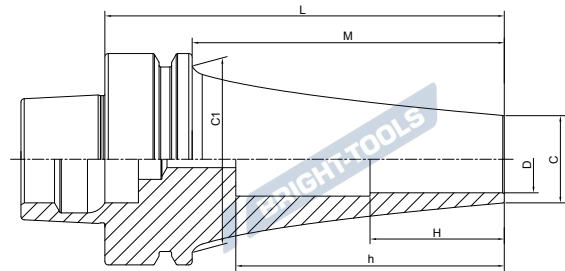

Size	D	C	L	M	C1	H	h
HSK63F-SFSA10-90 CV	10	13	90	64	53	30	65
HSK63F-SFSA10-120 CV	10	13	120	94	53	30	95
HSK63F-SFSA10-150 CV	10	13	150	124	53	30	125
HSK63F-SFSA10-180 CV	10	13	180	154	53	30	154
HSK63F-SFSA10-210 CV	10	13	210	184	53	30	184
HSK63F-SFSA10-240 CV	10	13	240	214	53	30	212
HSK63F-SFSA10-270 CV	10	13	270	244	53	30	244
HSK63F-SFSA10-300 CV	10	13	300	274	53	30	274
HSK63F-SFRA10-90 CV	10	19	90	64	53	30	65
HSK63F-SFRA10-120 CV	10	19	120	94	53	30	95
HSK63F-SFRA10-150 CV	10	19	150	124	53	30	125
HSK63F-SFRA10-180 CV	10	19	180	154	53	30	155
HSK63F-SFRA10-210 CV	10	19	210	184	53	30	185
HSK63F-SFFA10-90 CV	10	19	90	64	53	30	65
HSK63F-SFFA10-120 CV	10	19	120	94	53	30	95
HSK63F-SFFA10-150 CV	10	19	150	124	53	30	125
HSK63F-SFFA10-180 CV	10	19	180	154	53	30	155
HSK63F-SFFA10-210 CV	10	19	210	184	53	30	185

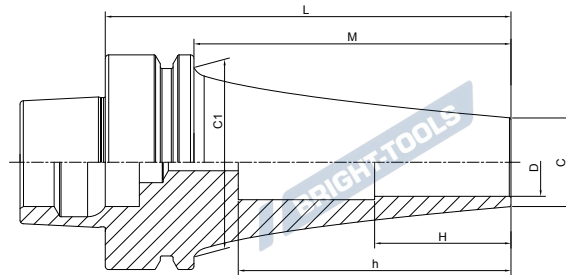
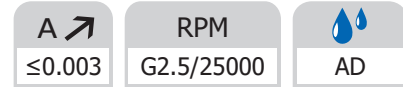

Shrink Chuck, Curved
 热缩刀柄，曲线型

Size	D	C	L	M	C1	H	h
HSK63F-SFSA12-90 CV	12	15	90	64	53	30	64
HSK63F-SFSA12-120 CV	12	15	120	94	53	30	94
HSK63F-SFSA12-150 CV	12	15	150	124	53	30	124
HSK63F-SFSA12-180 CV	12	15	180	154	53	30	154
HSK63F-SFSA12-210 CV	12	15	210	184	53	30	184
HSK63F-SFSA12-240 CV	12	15	240	214	53	30	212
HSK63F-SFSA12-270 CV	12	15	270	244	53	30	244
HSK63F-SFRA12-90 CV	12	22	90	64	53	30	64
HSK63F-SFRA12-120 CV	12	22	120	94	53	30	94
HSK63F-SFRA12-150 CV	12	22	150	124	53	30	124
HSK63F-SFRA12-180 CV	12	22	180	154	53	30	154
HSK63F-SFRA12-210 CV	12	22	210	184	53	30	184
HSK63F-SFFA12-90 CV	12	22	90	64	53	30	64
HSK63F-SFFA12-120 CV	12	22	120	94	53	30	94
HSK63F-SFFA12-150 CV	12	22	150	124	53	30	124
HSK63F-SFFA12-180 CV	12	22	180	154	53	30	154
HSK63F-SFFA12-210 CV	12	22	210	184	53	30	184
HSK63F-SFSB16-90 CV	16	21	90	64	53	32	62
HSK63F-SFSB16-120 CV	16	21	120	94	53	32	92
HSK63F-SFSB16-150 CV	16	21	150	124	53	32	122
HSK63F-SFSB16-180 CV	16	21	180	154	53	32	152
HSK63F-SFSB16-210 CV	16	21	210	184	53	32	182
HSK63F-SFSB16-240 CV	16	21	240	214	53	32	212
HSK63F-SFSB16-270 CV	16	21	270	244	53	32	242
HSK63F-SFSB20-90 CV	20	26	90	64	51	40	62
HSK63F-SFSB20-120 CV	20	26	120	94	53	40	92
HSK63F-SFSB20-150 CV	20	26	150	124	53	40	122
HSK63F-SFSB20-180 CV	20	26	180	154	53	40	152
HSK63F-SFSB20-210 CV	20	26	210	184	53	40	182
HSK63F-SFSB20-240 CV	20	26	240	214	53	40	212
HSK63F-SFSB20-270 CV	20	26	270	244	53	40	242

BRIGHT-TOOLS

BRIGHT-TOOLS

MACHINERY

**SHRINK FIT
MACHINES**

BRIGHT-TOOLS

BRIGHT-TOOLS

BRIGHT-TOOLS

BRIGHT-TOOLS

BRIGHT-TOOLS

BRIGHT-TOOLS

Shrink Fit Machine, Standard 刀柄热胀仪, 标准型

Size: HSM STD 2.0

Voltage: 3 x 380V 50HZ

Power: 15KW

Diameter: $\Phi 3$ - $\Phi 32$

DxWxH: 690x550x820

- HSM STD 2.0 is the standard desktop shrink fit machine, which heats the shrink fit holders through the principle of electromagnetic induction to achieve carbide cutting tool loading and unloading. This machine is with 7" touch-display, automatic parameter setting, and is easy to use.
- HSM STD 2.0 是标准款台式热缩机，通过电磁感应原理对热缩刀柄加热，实现硬质合金刀具的装刀和卸刀。设备配备7寸触摸屏，自动化参数设置，使用简单。



供货范围 Delivery Parts 配件明细 Spare Parts



感应装置主机设备15KW 50HZ
Shrink Fit Machine Body 15KW 50HZ



1根电源线
1 power cord



1个刀柄座
1 tool holder base



2个刀柄转换套
2 tool holder adapters



1把卡簧钳
1 bent circlip pliers



1套铣刀定位卡环
1 set of end mill clamping ring



1副防护手套
1 pair of protective gloves



1副防护镜
1 pair of protective glasses



1份操作说明
1 operating instructions

刀柄转换套：标配是2个，BT/SK/CAT40 一个，HSK63A 一个，其他规格转换套另行购买。
Tool Holder changing adapter set : Standard is for 2pcs, one is for BT/SK/CAT40, another is for HSK63A, other specification adapters sets need to be purchased separately.

Shrink Fit Machine Cooling Version 刀柄热胀仪, 水冷型

	Machine	Chiller
Size	HSM CLT II	CW-5000
Voltage	3x380V 50HZ	220V 50-60HZ
Power	15KW	0.75-1KW
Diameter	φ3-φ32	
DxWxH	690x580x1528	

- HSM CLT II is equipped with a circulating water cooler, it can cool the tool holder and the tool quickly. It has a 7"-touch-display with automatic parameter setting, which is easy to use.
- HSM CLT II 配备循环式水冷机可快速实现刀柄与刀具的冷却，7寸触摸屏自动化参数设置，使用简单。



供货范围 Delivery Parts 配件明细 Spare Parts



1 热缩机水冷一体机
1 shrink fit machine



1 根电源线
1 power cord



1 个刀柄座
1 tool holder base



2 个刀柄转换套
2 tool holder adapt



1 把卡簧钳
1 bent circlip pliers



1 套铣刀定位卡环
1 set of end mill clamping ring



1 副防护手套
1 pair of protective gloves



1 副防护镜
1 pair of protective glasses



1 份操作说明
1 operating instru

刀柄转换套：标配是 2 个，BT/SK/CAT40 一个，HSK63A 一个，其他规格转换套另行购买。
Tool Holder changing adapter set : Standard is for 2pcs, one is for BT/SK/CAT40, another is for HSK63A, other specification adapters sets need to be purchased separately.

BRIGHT-TOOLS

BRIGHT-TOOLS

BRIGHT-TOOLS

BRIGHT-TOOLS

BRIGHT-TOOLS

BRIGHT-TOOLS

BRIGHT-TOOLS

BRIGHT-TOOLS